



PC 3800-1

PRELIMINARY

**Pedestal Crane
650 t**

DEMAG[®]
BY TEREX

Specifications · Technische Daten · Caractéristiques · Dati tecnici · Datos técnicos · Especificações · Технические характеристики	5
Superlift configurations · Superlift-Konfigurationen · Combinaisons Superlift · Configurazioni Superlift · Configuraciones Superlift · Configurações do Superlift · Варианты конфигурации суперлифт	9
Specifications · Technische Daten · Caractéristiques · Dati tecnici · Datos técnicos · Especificações · Технические характеристики	10
Road transport · Straßentransport · Transport sur route · Trasporto su strada · Transporte por carretera · Transporte rodoviário · Транспортировка автомобилем	12
Job site transport · Transport zur Einsatzstelle · Transport sur le chantier · Trasporto in cantiere · Transporte en el lugar de trabajo · Transporte até o canteiro de obra · Перемещение по рабочей площадке	13
Erection / lowering · Aufrichten / Ablegen · Monter / déposer · Montaggio / calata · Erección / descenso · Levantamento / descida · Подъем/опускание	14
Boom combinations · Ausleger-Kombinationen · Combinaisons de flèche · Combinazioni braccio · Combinaciones de pluma · Combinações de lanças · Комбинации стрелы	16

Main boom · Hauptausleger · Flèche principale · Braccio base · Pluma principal · Lança principal · Главная стрела (SH, LH)	22
Main boom with SL · Hauptausleger mit SL · Flèche principale avec SL · Braccio base con SL · Pluma principal con SL · Lança principal com SL · Главная стрела с SL (SSL, LSL)	28

Fixed fly jib · Starrer Hilfsausleger · Fléchette fixe · Falcone fisso · Plumín fijo · Lança auxiliar fixa · Неподвижная стрела с изменяемым вылетом (SH+LF, LH+LF)	44
Fixed fly jib with SL · Starrer Hilfsausleger mit SL · Fléchette fixe avec SL · Falcone fisso con SL · Plumín fijo con SL · Lança auxiliar fixa com SL · Неподвижная стрела с изменяемым вылетом с SL (SSL+LF)	60
Fixed fly jib with SL · Starrer Hilfsausleger mit SL · Fléchette fixe avec SL · Falcone fisso con SL · Plumín fijo con SL · Lança auxiliar fixa com SL · Неподвижная стрела с изменяемым вылетом с SL (LSL+LF)	74

Technical description · Technische Beschreibung · Descriptif technique · Descrizione tecnica · Descripción técnica · Descrição técnica · Техническое описание	116
--	-----

Zeichenerklärung · Légende · Leggenda · Leyenda · Legenda · Условные обозначения

	Lifting capacities on outriggers · Tragfähigkeiten, abgestützt · Capacités de levage sur stabilisateurs · Portate su stabilizzatori · Capacidad de elevación sobre apoyos · Capacidades de içamento sobre estabilizadores · Грузоподъемность с выдвинутыми опорами	„D“	
	Counterweight · Gegengewicht · Contrepoids · Contrappeso · Contrapeso · Contrapeso · Противовес	S:	heavy · schwer · lourd · pesante · pesado · pesada · сильный
	Superlift counterweight · Superlift-Gegengewicht · Contrepoids Superlift · Contrappeso Superlift · Contrapeso Superlift · Contrapeso do Superlift · Противовес суперлифт	L:	light · leicht · léger · leggera · ligero · leve · слабый
	Superlift radius · Superlift-Radius · Rayon Superlift · Sbraccio Superlift · Radio de Superlift · Raio do Superlift · Радиус для оборудования суперлифт	H / HA:	Main boom · Hauptausleger · Flèche principale · Braccio principale · Pluma principal · Lança principal · Главная стрела
	Possible load of hook block · Mögliche Traglast Unterflasche · Charge possible de crochet-moufle · Portata possibile di bozzello · Carga permitida de gancho · Carga possível do moitão · Допустимая нагрузка на крюкоблок	HI:	Luffing jib · Hilfsausleger · Fléchette · Falcone · Plumín · Lança auxiliar · Стрела с изменяемым вылетом
	Weight of hook block · Gewicht Unterflasche · Poids de crochet-moufle · Peso di bozzello · Peso de gancho · Peso do moitão · Вес крюкоблока	W:	Luffing fly jib · Wippbarer Hilfsausleger · Fléchette à volée variable · Falcone a volata variabile · Plumín abatible · Jib de lance variável · Стрела с изменяемым углом вылета и гуськом
	Load radius · Lastradius · Portée · Raggio di lavoro · Radio de trabajo · Raio de operação · Рабочий радиус	F:	Fixed fly jib · Starrer Hilfsausleger · Fléchette fixe · Falcone fisso · Plumín fijo · Lança auxiliar fixa · Неподвижная стрела с изменяемым вылетом
	Main boom · Hauptausleger · Flèche principale · Braccio principale · Pluma principal · Lança principal · Главная стрела	SL:	Superlift · Superlift · Levage supplémentaire · Superlift · Superlift · Kit Superlift · Суперлифт (система для увеличения грузоподъемности)
	Fly jib · Hilfsausleger · Fléchette · Falcone · Plumín · Lança auxiliar · Стрела с изменяемым вылетом	V:	Vessellift · Vessellift · Vessellift · Vessellift · Vessellift · Içamento de embarcação · Подъем судов
	Main boom angle · Hauptauslegerwinkel · Jarret de flèche principale · Inclinazione braccio base · Ángulo de pluma principal · Ângulo da lança principal · Угол наклона главной стрелы		
	Fly jib angle · Hilfsauslegerwinkel · Jarret de fléchette · Inclinazione falcone · Ángulo de plumín · Ángulo da lança auxiliar · Угол наклона стрелы с изменяемым вылетом		
	Wind speed in m/s (meter per second) · Windgeschwindigkeit in m/s · Vitesse du vent en m/s · Velocità del vento in m/s (metri al secondo) · Velocidad del viento en m/s · Velocidade do vento em m/s (metros por segundo) · Скорость ветра в м/сек		

- ▶ 650 t at 12 m radius
 - ▶ Load moment of 8784 tm
 - ▶ Fall protection as standard
 - ▶ Erection of main boom 114 m with 12 m LF and hook block mounted: without superlift mast and without assist crane
 - ▶ Erection of wind turbines up to **170 m** hub height with superlift
 - ▶ Best in class ergonomics for operator
 - ▶ Suitable for worldwide operation
-
- ▶ 650 t Tragfähigkeit bei 12 m Radius
 - ▶ Max. Lastmoment 8784 mt
 - ▶ Absturzsicherung serienmäßig
 - ▶ Aufrichten des 114 m Hauptauslegers mit angebautem 12 m LF und Haken ohne Superliftmast und ohne Hilfskran
 - ▶ Errichtung von Windturbinen mit einer Nabenhöhe von bis zu **170 m** mit Superlift
 - ▶ Bedienerergonomie der Spitzenklasse
 - ▶ Für weltweiten Einsatz konzipiert
-
- ▶ 650 t à 12 m de rayon
 - ▶ Moment de charge de 8784 tm
 - ▶ Protection anti-chute en série
 - ▶ Montage de la flèche principale de 114 m avec 12 m LF et crochet moufle montés : sans mât superlift et sans grue auxiliaire
 - ▶ Installation de turbines d'éoliennes jusqu'à **170 m** de hauteur de moyeu avec superlift
 - ▶ Ergonomie optimale du poste de conduite
 - ▶ Conçue pour une utilisation dans le monde entier
-
- ▶ Portata di 650 t entro 12 m
 - ▶ Momento di carico di 8784 tm
 - ▶ Protezione anticaduta di serie
 - ▶ Braccio 114 m configurabile con LF 12 m e bozzello montati: senza superlift e senza gru ausiliaria
 - ▶ Montaggio di turbine eoliche con altezza del mozzo di **170 m** con superlift
 - ▶ Comandi ergonomici di prim'ordine per il comfort dell'operatore
 - ▶ Concepita per l'uso internazionale
-
- ▶ 650 t para radio de 12 m
 - ▶ Momento de carga máx. 8784 tm
 - ▶ Protección contra caídas de serie
 - ▶ Erección de pluma principal 114 m con LF de 12 m y bloque de gancho montado: sin mástil superlift ni grúa auxiliar
 - ▶ Montaje de turbinas eólicas de hasta **170 m** de altura de eje con superlift
 - ▶ Mejor ergonomía para el operador de su clase
 - ▶ Adecuada para operaciones a nivel mundial
-
- ▶ 650 t com 12 m de raio
 - ▶ Momento de carga de 8784 t
 - ▶ Proteção contra quedas de série
 - ▶ Montagem de lança principal de 114 m com auxiliar de 12 m e moitão instalados; sem mastro do superlift e sem guindaste de apoio
 - ▶ Montagem de turbinas eólicas até **170 m** de altura do cubo com Superlift
 - ▶ Ergonomia inigualável para o operador
 - ▶ Recomendado para operação no mundo inteiro
-
- ▶ 650 т при радиусе 12 м
 - ▶ Грузовой момент 8784 тм
 - ▶ Защита от падения с высоты в стандартной
 - ▶ Высота главной стрелы 114 м с вспом. стрелой LF длиной 12 м и установленным крюкоблоком: без мачты суперлифт и без вспомогательного крана
 - ▶ Установка ветрогенераторов с высотой до ступицы ветроколеса до **170 м** с использованием системы суперлифт
 - ▶ Лучшая к классе эргономика для оператора
 - ▶ Пригоден для использования в любой стране мира

Specifications

PC 3800-1

Technische Daten · Caractéristiques · Dati tecnici ·
Datos técnicos · Especificações · Технические характеристики

**Working speeds (infinitely variable) · Arbeitsgeschwindigkeiten (stufenlos regelbar) ·
Vitesses de travail (réglables sans paliers) · Rapporti di lavoro (a regolazione continua) ·
Velocidades de trabajo (progresión continua) · Velocidades de trabalho (infinitamente
variáveis) · Рабочие скорости (с бесступенчатой регулировкой)**

Mechanism Antrieb Mécanisme Funzioni Mecanismos Mecanismo Механизм	Rope ø Seil-ø ø du câble ø fune ø cable Diâm. cabo Диаметр троса	Speeds ¹⁾ Geschwindigkeiten ¹⁾ Vitesses ¹⁾ Rapporti ¹⁾ Velocidades ¹⁾ Velocidades ¹⁾ Скорости ¹⁾	Single line pull Seilzug je Strang Effort sur brin simple Tiro fune singolo Tracción de cable simple Tração de linha simples Тяговое усилие на одиночном тросе	Length of hoist rope Länge des Hubseils Longueur du câble de levage Lungh. della fune dell'argano Long. de cable de cabrestante Compr. do cabo do guincho Длина троса
Hoist I+II · Hubwerk I+II · Treuil de levage I+II · Agano I+II · (H1+H2) Cabrestante I+II · Guincho I+II · подъем I+II	28 mm	max. 130 m/min	180 kN	1000 m
Hoist III · Hubwerk III · Treuil de levage III · Agano III · (H3) Cabrestante III · Guincho III · подъем III	28 mm	max. 80 m/min	180 kN	650 m
Boom derricking · Wippwerk Hauptausleger · Variation de flèche · Inclinazione del braccio · (W2) Descenso de pluma · Inclinação da lança · Подъем стрелы деррик-краном	28 mm	max. 130 m/min		
Boom hoist · Einziehwerk · Relevage de flèche · Argano del braccio · (E) Cabrestante de pluma Guincho da lança · Подъем стрелы	28 mm	max. 125 m/min		
Jib luffing · Wippwerk Hilfs- ausleger · Variation de volée · Sollevamento del braccio · (W1) Abatimiento de plumín · Inclinação da lança auxiliar · Изменение вылета стрелы	28 mm	max. 120 m/min		
Slewing (rpm) · Drehwerk (U/min) Orientation (tr / mn) · Rotazione (rpm) · Unidad de giro (rpm) · Giro (rpm) · Поворот (rpm)		0-1		

¹⁾ top layer · oberste Lage · couches supérieure · avvolgimento superiore · capa superior · camada superior · верхний слой

Specifications

PC 3800-1

Technische Daten · Caractéristiques · Dati tecnici ·
Datos técnicos · Especificações · Технические характеристики

Hook block system · Unterflaschensystem · Système de crochet-moufle · Sistema per bozzello · Sistema de bloque de gancho · Sistema de moitão · Система крюкоблока

Type Typ Type Tipo Tipo Tipo Тип	Possible load Mögliche Traglast Charge possible Portata possibile Carga permitida Carga possível Допустимая нагрузка	Number of sheaves Anzahl der Rollen Nombre de poulies Numero di pulegge Total de poleas Número de polias Количество шкивов	Number of lines Strangzahl Nombre de brins No max avvolgim. Reenvíos máx. Número de cabos Кратность троса	Weight Gewicht Poids Peso Peso Peso Вес	„D“
2 x 325	650 t	4 x 5	2 x 20	10,1 t – 13,2 t	5,60 m
	380 t	1 x 10	1 x 21	7,3 t – 11,3 t (3,8 t – 11,0 t*)	5,60 m (4,90 m*)
2 x 190	380 t	2 x 5	2 x 11	7,3 t – 11,3 t (3,8 t – 11,0 t*)	5,90 m (4,90 m*)
	190 t	1 x 5	1 x 11	6,2 t (2,7 t – 4,8 t*)	5,90 m (5,20 m*)

* with optional equipment 400 t hook or 200 t hook · mit optionalem 400 t Haken oder 200 t Haken · avec équipement optionnel: crochet de 400 t ou crochet de 200 t hook · con gancio opzionale da 400 t o 200 t · con equipamiento opcional, gancho 400 t o 200 t · com gancho de 400 t ou 200 t como equipamento opcional · с опциональным крюком 400 т или 200 т

Double hook block · Doppel-Unterflasche · Crochet-moufle double · Doppio bozzello · Bloque de gancho doble · Moitão duplo · Крюкоблок с двумя крюками

Type Typ Type Tipo Tipo Tipo Тип	Possible load Mögliche Traglast Charge possible Portata possibile Carga permitida Carga possível Допустимая нагрузка	Number of sheaves Anzahl der Rollen Nombre de poulies Numero di pulegge Total de poleas Número de polias Количество шкивов	Number of lines Strangzahl Nombre de brins No max avvolgim. Reenvíos máx. Número de cabos Кратность троса	Weight Gewicht Poids Peso Peso Peso Вес	„D“
2 x 90	178 t	2 x 2	2 x 5	2,3 t – 8,9 t	4,50 m

Hook block · Unterflasche · Crochet-moufle · Bozzello · Bloque de gancho · Moitão · Крюкоблок

Type Typ Type Tipo Tipo Tipo Тип	Possible load Mögliche Traglast Charge possible Portata possibile Carga permitida Carga possível Допустимая нагрузка	Number of sheaves Anzahl der Rollen Nombre de poulies Numero di pulegge Total de poleas Número de polias Количество шкивов	Number of lines Strangzahl Nombre de brins No max avvolgim. Reenvíos máx. Número de cabos Кратность троса	Weight Gewicht Poids Peso Peso Peso Вес	„D“
125	123,5 t	1 x 3	1 x 7	1,8 t – 5,1 t	4,60 m
54	54 t	1 x 1	1 x 3	1,1 t – 3,3 t	4,50 m
18*	18 t	–	1 x 1	1,1 t	3,90 m

* Single line hook / Hakengehänge / Boulet / Gancio singolo / Gancho simple / Gancho para linha singela / Крюк на одиночном тросе

Specifications

PC 3800-1

Technische Daten · Caractéristiques · Dati tecnici ·
Datos técnicos · Especificações · Технические характеристики

**Basic crane dimensions · Hauptabmessungen · Dimensions de la grue de base ·
Dimensioni di base della gru · Dimensiones básicas de la grúa · Dimensões do guindaste
básico · Базовые габариты крана**

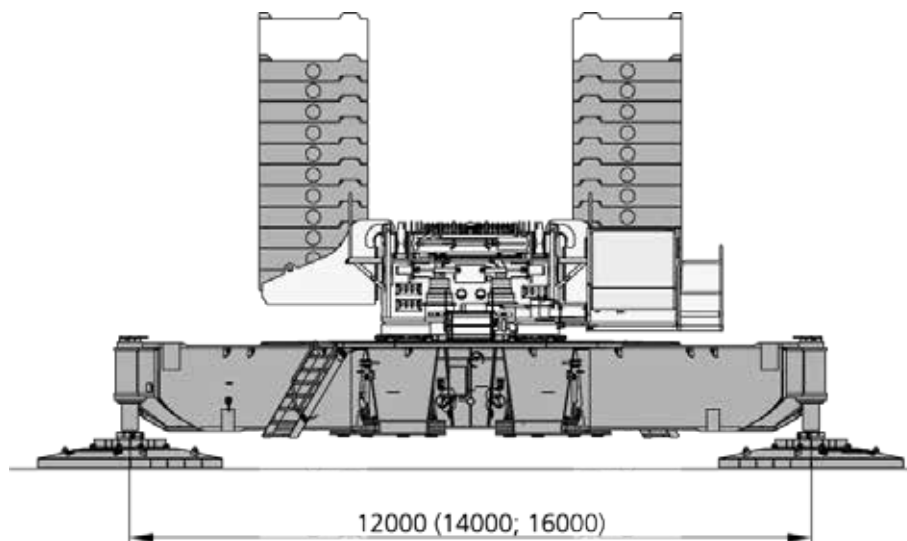
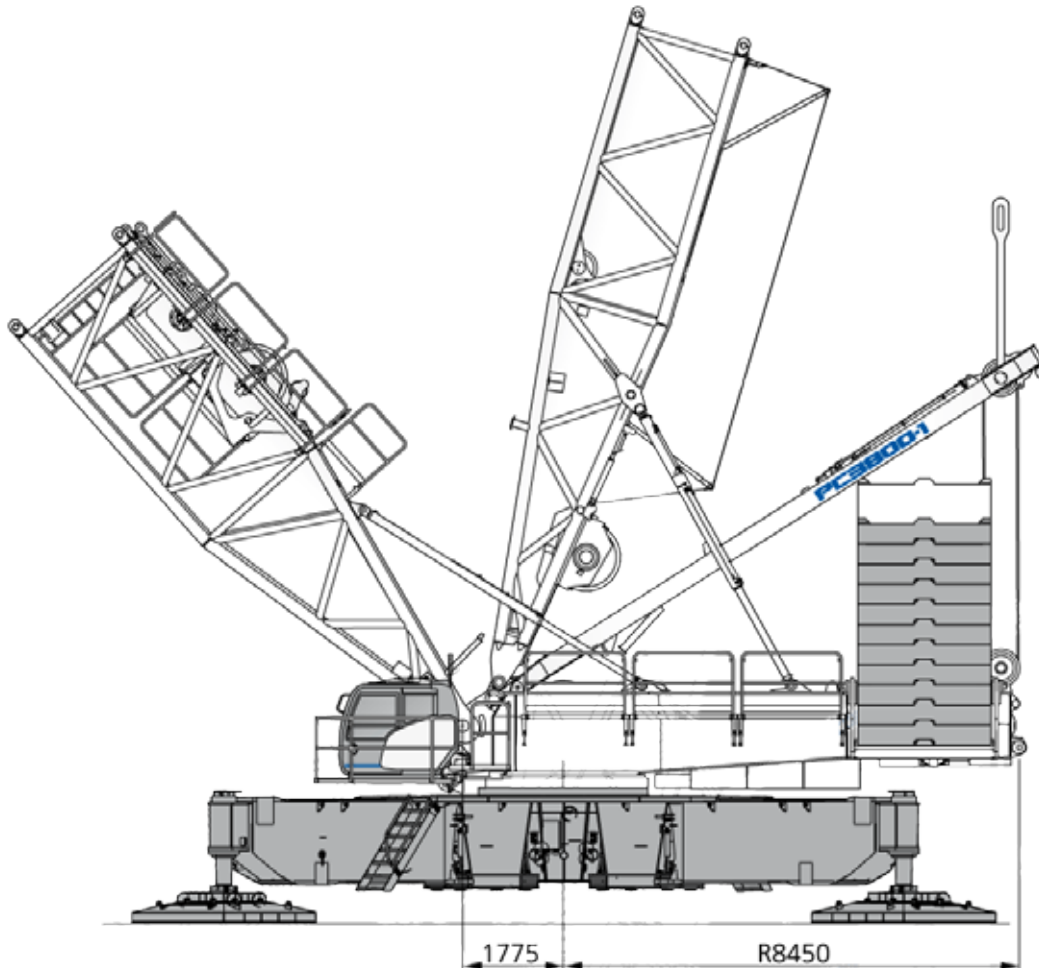

Specifications

PC 3800-1

Technische Daten · Caractéristiques · Dati tecnici ·
Datos técnicos · Especificações · Технические характеристики

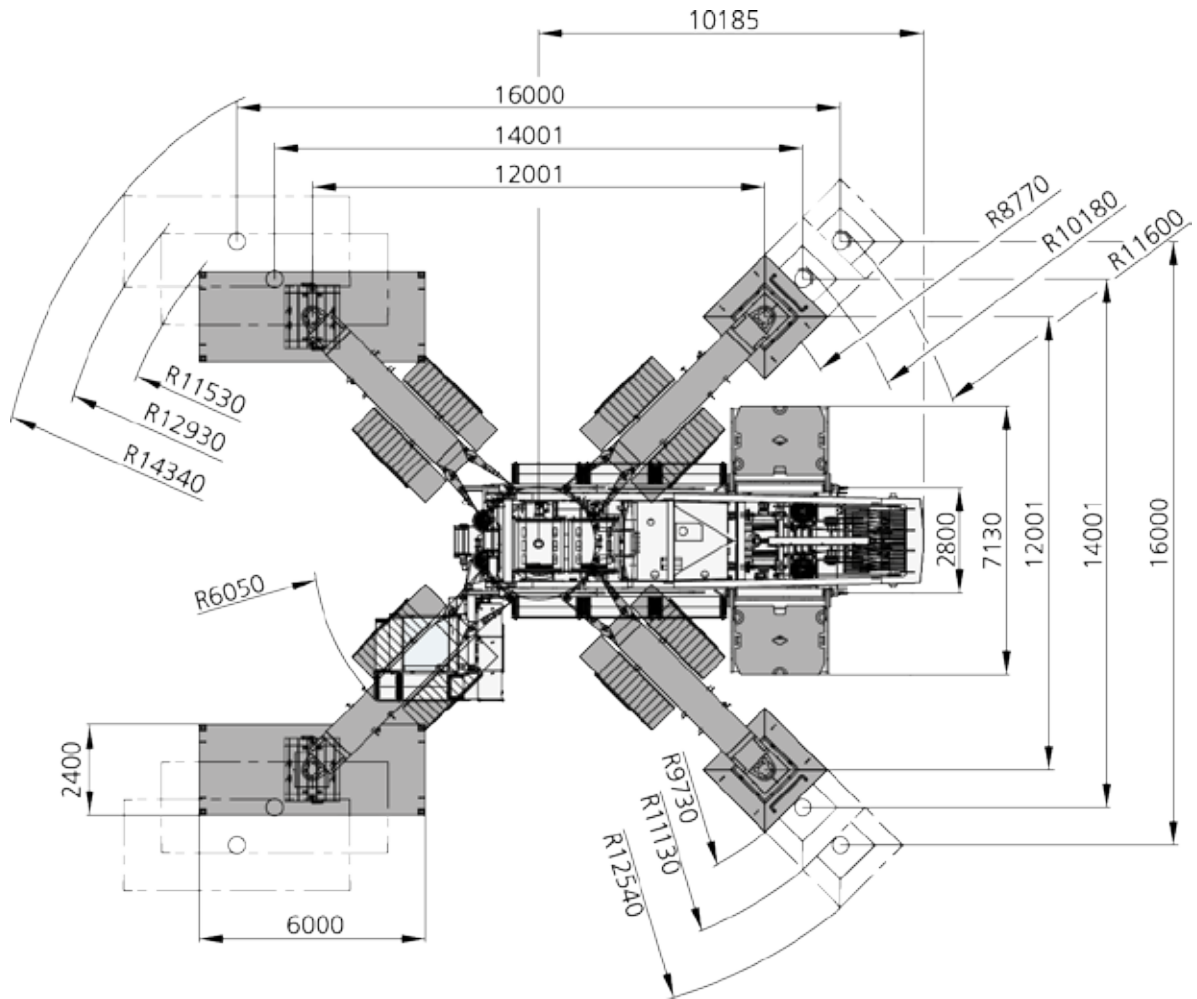

Superlift Configurations

PC 3800-1

Superlift-Konfigurationen · Combinaisons Superlift ·
 Configurazioni Superlift · Configuraciones Superlift ·
 Configurações do Superlift · Варианты конфигурации суперлифт

SL 0 t 9 m

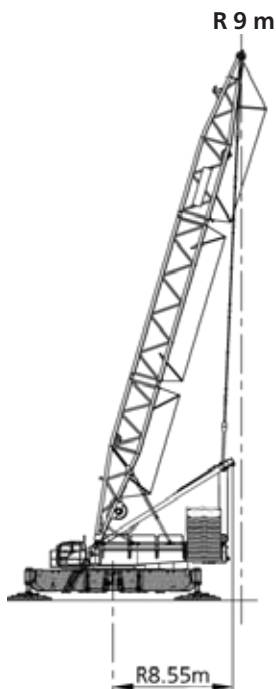

Standard-SL

R 11.5 15.5 19.5m

13.5 17.5

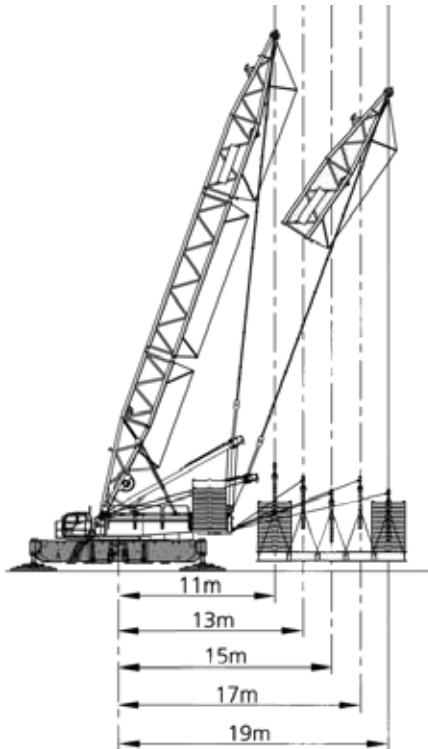

Vario-SL 11-19 m*

R 11.5 - 19.5 m

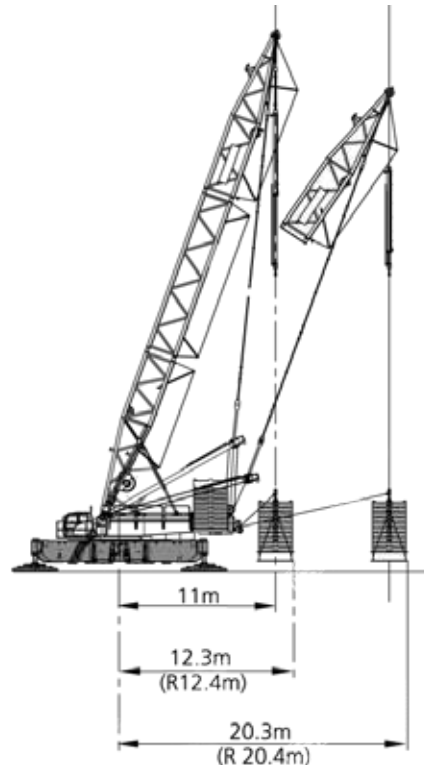

SL Carrier · SL-Wagen · Châssis SL · Carro SL · Carro SL · Veículo do SL · Шасси SL

15-19 m

R 15.75 m

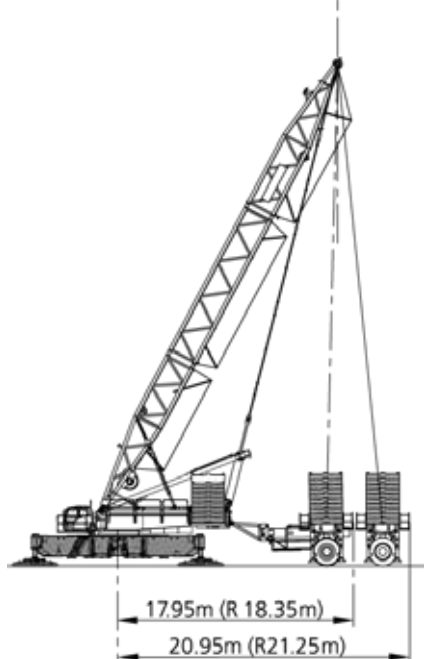

Flex Frame**

13-21 m

R 13.75 m

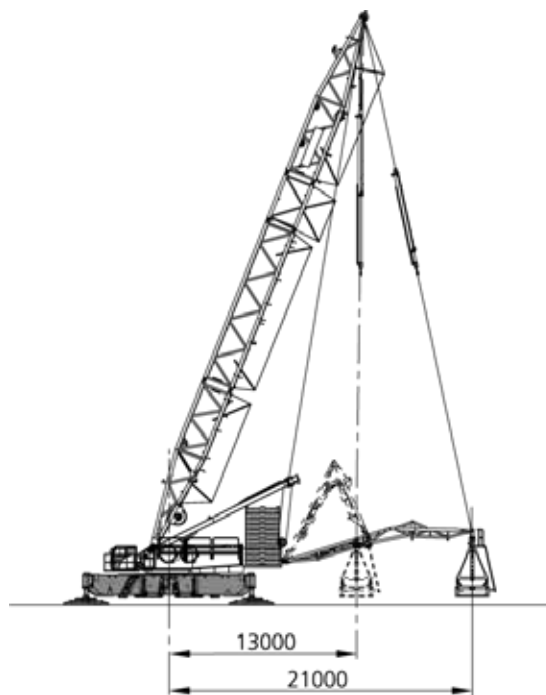

* with SL mast 39.5 m: 11-21 m · mit SL-Mast 39,5 m: 11-21 m · avec mât SL 39,5 m: 11-21 m · con albero SL 39,5 m: 11-21 m · con mástil SL 39,5 m: 11-21 m · com torre SL 39,5 m: 11-21 m · с мачтой SL 39,5 м: 11-21 м

** only in combination with SL masts 39.5 m or 42 m · nur in Verbindung mit SL-Mast 39,5 m und 42 m · seulement combiné aux mâts SL 39,5 ou 42 m · con in combinazione con alberi SL 39,5 m o 42 m · solo en combinación con mástiles SL 39,5 m o 42 m · somente combinado com torres SL de 39,5 m ou 42 m · только в сочетании с мачтами SL 39,5 м или 42 м

Technische Daten · Caractéristiques · Dati tecnici ·
 Datos técnicos · Especificações · Технические характеристики

Weights · Gewichte · Poids · Peso · Peso · Peso · Вес

<p>Total weight incl. 225 t counterweight, 24 m boom and hook block Gesamtgewicht einschl. 225 t Gegengewicht, 24 m Hauptausleger und Unterflasche Poids avec 225 t de contrepoids, flèche de 24 m et crochet Peso totale incl. contrappeso 225 t, braccio 24 m e bozzello Peso total incl. contrapeso de 225 t, pluma de 24 m y bloque de gancho Peso total incl. Contrapeso de 225 t, lança de 24 m e moitão Общий вес, включая противовес 225 т, стрелу длиной 24 м и крюкоблок</p>	approx. 340 t
<p>Superstructure (with 3 winches, A-frame and quick-connection) Oberwagen (mit 3 Winden, A-Bock und Schnellverbindung) Partie supérieure (avec 3 tambours, chevalet et connexion rapide) Torretta (con 3 argani, cuspid e attacco rapido) Superestructura (con 3 cabrestantes, caballete y conexión rápida) Superestructura (com 3 guinchos, suporte angular e engate rápido) Надстройка (с 3 лебедками, А-образной рамой и системой быстроразъемных соединений)</p>	71,6 t
<p>Superstructure without winches and A-frame, with quick-connection Oberwagen ohne Winden und A-Bock mit Schnellverbindung Partie supérieure sans tambours et chevalet avec connexion rapide Torretta senza argani e cuspid e con attacco rapido Superestructura sin cabrestantes ni caballete con conexión rápida Superestructura sem guinchos e suporte angular com engate rápido Надстройка без лебедок и А-образной рамы с системой быстроразъемных соединений</p>	41,6 t
<p>Center pot with outriggers, mats and quick connection Mittelrahmen mit Abstützungen, Matten und Schnellverbindung Structure centrale avec stabilisateurs, mâts et connexions rapides Sezione centrale con stabilizzatori, piastre e raccordi rapidi Parte central con estabilizadores, bases y conexión rápida Base de giro central com estabilizadores, patolas e engate rápido Центральная чаша с опорами, подушками опор и быстроразъемными соединениями</p>	94,0 t
<p>Superstructure with A-frame, without H1, H2 with center pot with adapters for axle lines Oberwagen mit A-Bock, ohne H1, H2 mit Mittelrahmen inkl. Adaptern für Achslinien Partie supérieure avec chevalet, sans treuil H1 ; treuil H2 avec structure centrales et adaptateurs pour axes d'essieu Torretta con cuspid e, senza H1, H2 con sezione centrale con adattatori per le linee degli assi Superestructura con caballete, sin H1, H2 con parte central con adaptadores para líneas de ejes Superestructura com suporte angular, sem H1, H2 com base de giro central com adaptadores para linhas de eixo Надстройка с А-образной рамкой, без H1, H2 с центральной чашей с адаптерами для осевых линий</p>	71,3 t
<p>Max. Counterweight Max. Gegengewicht · Contrepoids max. · Max. contrappeso · Contrapeso máx. · Máx. contrapeso · Макс. вес противовеса</p>	225 t

Specifications

PC 3800-1

Technische Daten · Caractéristiques · Dati tecnici ·
 Datos técnicos · Especificações · Технические характеристики

**PC center pot with quick connection and support frames · PC-Mittelrahmen mit Schnell-
 verbindung und Tragrahmen · Structure centrale PC avec connexions rapides et cadres de
 support · Sezione centrale tipo gru su piedistallo con raccordi rapidi e telai di supporto ·
 Parte central PC con conexión rápida y marcos de soporte · Base de giro central para PC
 com engate rápido e quadros de apoio · Центральная чаша кранов серии PC с
 быстроразъемными соединениями и несущими рамами**

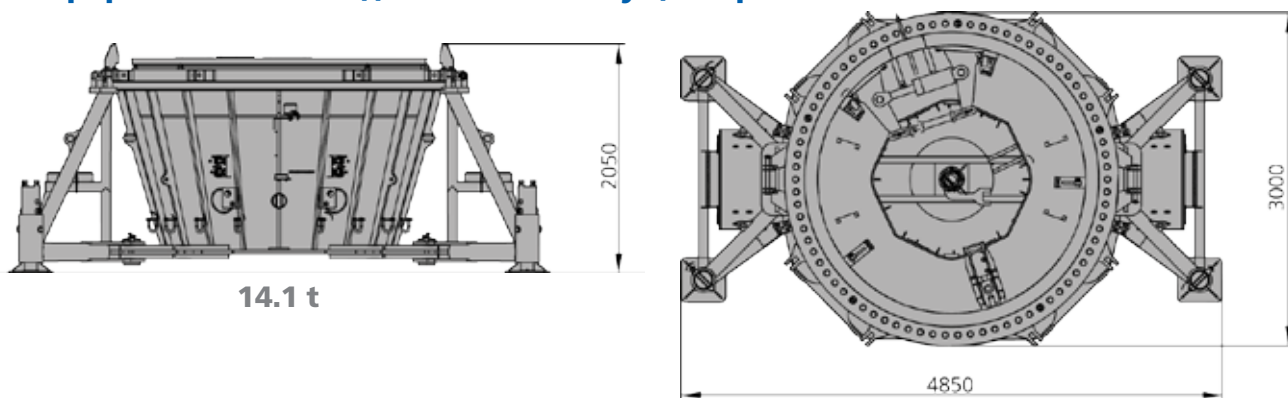

**Telescopic outriggers with connection part · Teleskopabstützungen mit Anschlussstück ·
 Stabilisateurs télescopiques avec section de connexion · Stabilizzatori telescopici con parte
 di raccordo · Estabilizadores telescópicos con pieza de conexión · Estabilizadores telescópicos
 com componente de conexão · Телескопические опоры с соединительной частью**

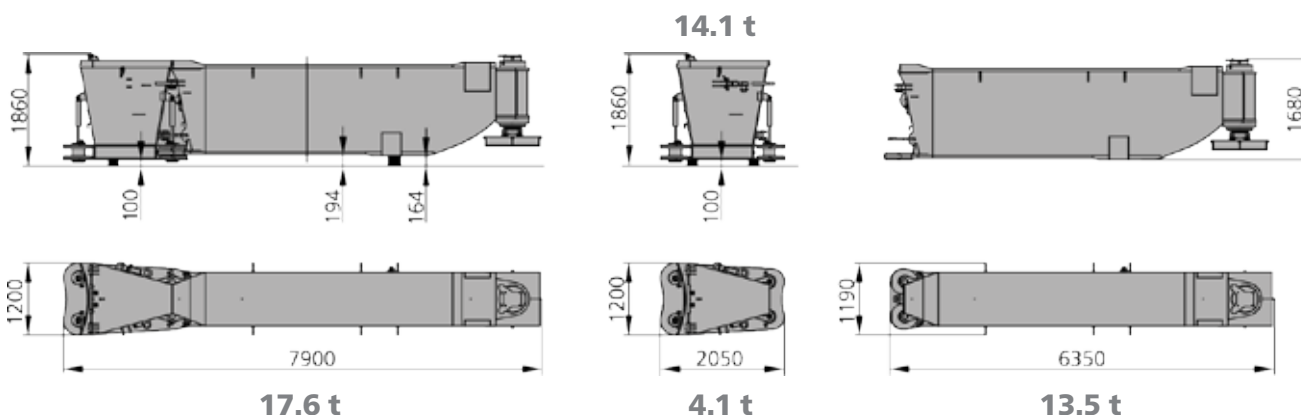

**Outrigger mats (stackable) · Abstützplatten (stapelbar) · Semelles de calage (empilables) ·
 Piastre per stabilizzatori (impilabili) · Bases de estabilizadores apilables) · Patolas do
 estabilizador (empilháveis) · Подушки опор (укладываются стопкой друг на друга)**

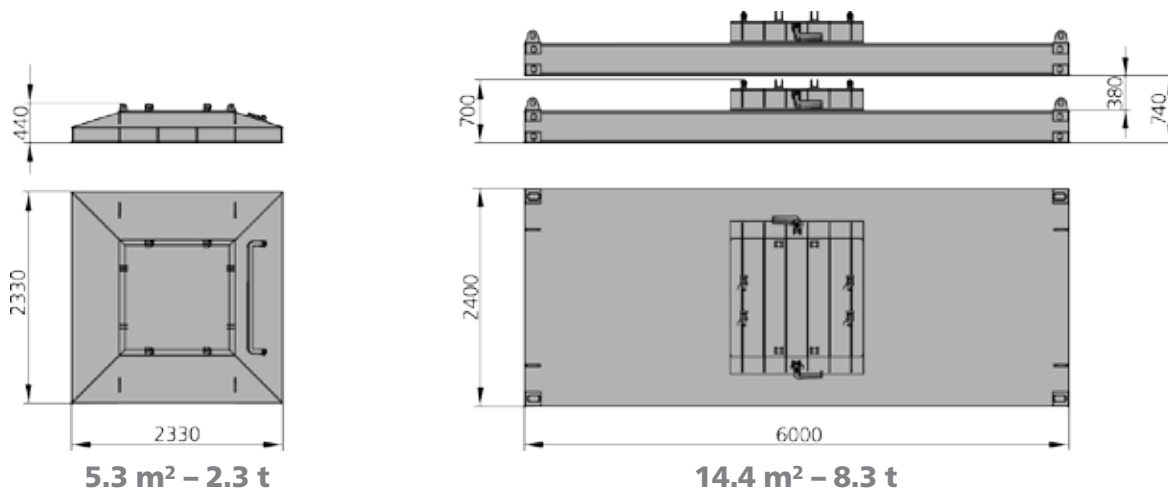

Road transport

PC 3800-1

Straßentransport · Transport sur route · Trasporto su strada · Transporte por carretera · Transporte rodoviário · Транспортировка автомобилем

Axle load < 12 t (without winches H1 + H2) · Achslast unter 12 t (ohne Hubwerke H1 + H2) · Charge à l'essieu < 12 t (sans treuils H1 + H2) · Carico assiale < 12 t (senza argani H1 + H2) · Carga por eje < 12 t (sin cabrestantes H1 + H2) · Carga axial < 12 t (sem guinchos H1 + H2) · Нагрузка на ось < 12 т (без лебедок H1 + H2)

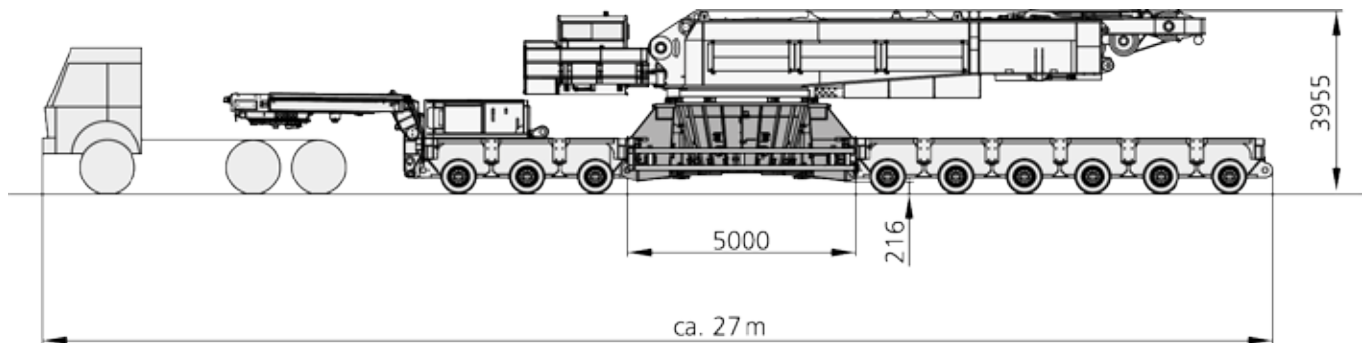

Total vehicle weight < 100 t (without winches H1 + H2, A-frame) · Fahrzeug-Gesamtgewicht unter 100 t (ohne Hubwerke H1 + H2, A-Rahmen) · Poids total du véhicule < 100 t (sans treuils H1 + H2, chevalet) · Peso veicolo totale < 100 t (senza argani H1 + H2, cuspidi) · Peso total del vehículo < 100 t (sin cabrestantes H1 + H2, caballete) · Carga total do veículo < 100 t (sem guinchos H1 + H2, suporte angular) · Общий вес транспортного средства < 100 т (без лебедок H1 + H2, А-образной рамы)

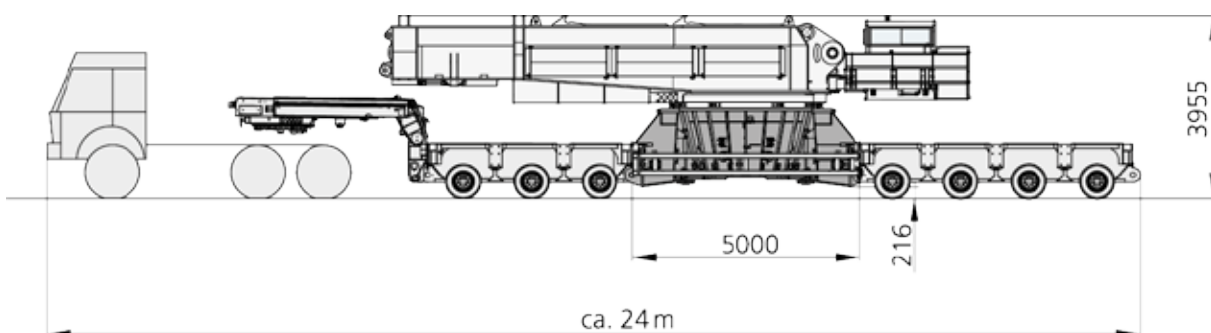

Job site transport

PC 3800-1

Transport zur Einsatzstelle · Transport sur le chantier ·
Trasporto in cantiere · Transporte en el lugar de trabajo · Transporte até
o canteiro de obra · Перемещение по рабочей площадке

with truck and goose neck, power pack optional · per LKW und Schwanenhalsauflieger;
Power-Pack optional · avec camion et potence à col de cygne, « power pack » en option ·
con camion e semirimorchio ribassato, gruppo idraulico opzionale · con camión y cuello
de cisne, Power-pack opcional · com caminhão e conector curvo, power pack opcional ·
с помощью автомобиля и S-образного рычага, силовой агрегат в виде
дополнительной опции

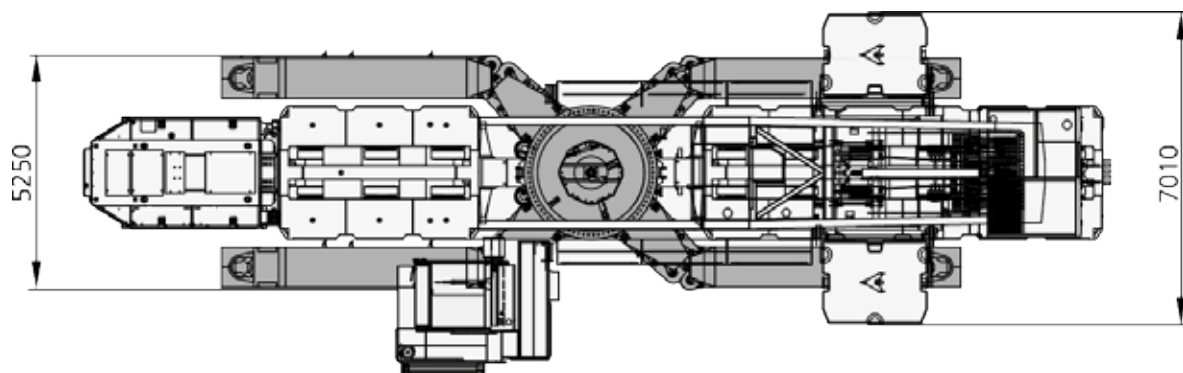
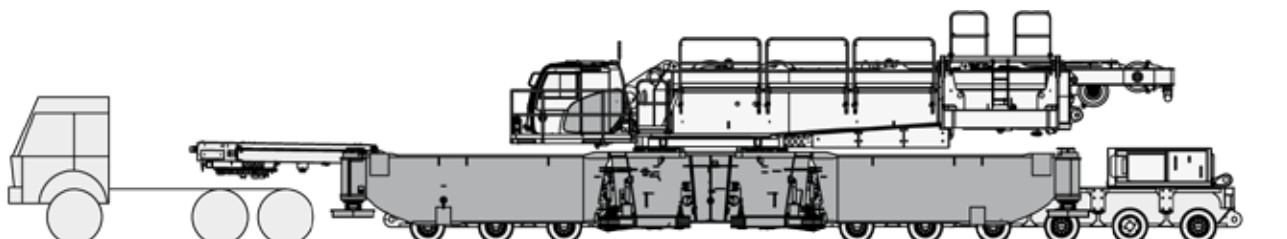

with power pack · mit Power-Pack · avec « power pack » · con gruppo idraulico ·
con Power-pack · com power pack · с силовым агрегатом

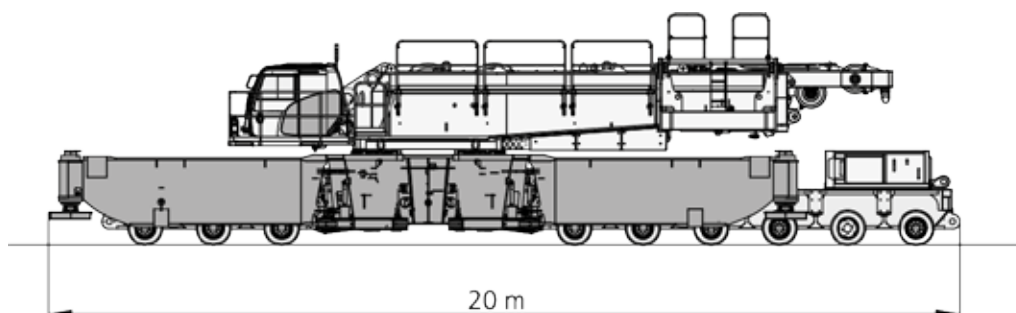

Erection / Lowering

PC 3800-1

Aufrichten / Ablegen · Montée / Placement · Montaggio / Calata ·
Erección / Descenso · Levantamento / Descida · Подъем / опускание

Erection / lowering of the PC 3800-1 boom systems to the ground · Aufrichten / Ablegen der PC 3800-1 Auslegersysteme · Montée / placement sur sol des systèmes de flèche de la PC 3800-1 · Montaggio / calata dei sistemi braccio PC 3800-1 a terra · Erección / descenso al terreno del sistema de pluma del PC 3800-1 · Levantamento / descida dos sistemas da lança do PC 3800-1 para o solo · Подъем / опускание системы стрелы крана PC 3800-1 на землю

Boom combination Auslegervariante Combinaison de flèche Combinazione braccio Combinación de pluma Combinação de lanças Комбинация стрелы	Fly jib (m) Hilfsausleger Fléchette Falcone Plumín Lança auxiliar Стрела с изменяемым вылетом	Main boom · Hauptausleger · Flèche principale · Braccio base · Pluma principal · Lança principal · Главная стрела																	
		m	24	30	36	42	48	54	60	66	72	78	84	90	96	102	108	114	
SH_1			X	X	X	X	X	X	X	X	X	X	X	X	(X)	–	–	–	
LH_1			–	–	X	X	X	X	X	X	X	X	X	X	X	X	(X)	[X]	
SW_1 85°	24																		
	30																		
	36																		
	42																		
	48																		
	54																		
	60																		
	66																		
	72																		
	78																		
84																			
90																			
96																			
SH+LF_1 15°, 20°, 30°	12		–	X	X	X	X	X	X	X	X	X	X	X	X	–	–	–	
	24		–	X	X	X	X	X	X	X	X	X	X	X	–	–	–	–	
	36		–	X	X	X	X	X	X	X	X	X	X	–	–	–	–	–	
LH+LF_1 15°, 20°, 30°	12		–	–	–	–	X	X	X	X	X	X	X	X	(X)	[X]	[X]	[X]	
	24		–	–	–	–	X	X	X	X	X	X	X	(X)	[X]	[X]	[X]	–	
	36		–	–	–	–	X	X	X	X	X	X	(X)	[X]	[X]	[X]	–	–	
		m		72	75	78	81	84	87	90	93	96	99	102	105	108	111		
LH+LF_3 15°, 20°	12			X	X	X	X	X	X	X	X	X	(X)	(X)	[X]	[X]	[X]		

X 12 m x 12 m, 14 m x 14 m, 16 m x 16 m

(X) 14 m x 14 m, 16 m x 16 m

[X] 16 m x 16 m

All Superlift combinations can be erected or lowered to the ground without assisting equipment.

Alle Varianten mit Superlift können ohne Zusatzausrüstung aufgerichtet bzw. abgelegt werden.

Montée et dépose sur sol de toutes les combinaisons avec SL sans équipement aditionnel.

Tutte le combinazioni Superlift possono essere alzate o abbassate a terra senza attrezzatura di supporto.

Todas las combinaciones Superlift se pueden erigir o descender al terreno sin equipamiento de asistencia.

Todas as combinações de Superlift podem ser levantadas ou baixadas ao solo sem equipamentos auxiliares.

Оборудование суперлифт в любой конфигурации поднимается и опускается на землю без вспомогательного оборудования.

page 15 · Seite 15 · page 15 · pagina 15 · página 15 · страница 15:

The amount of Superlift counterweight required for erecting the boom system depends on the configuration and the Superlift radius.

Die Menge des zum Aufrichten erforderlichen Superliftgegengewichts ist abhängig von Konfiguration und Superliftradius.

La valeur du contrepoids Superlift nécessaire au montage du système de flèche dépend de la configuration et du rayon Superlift.

La quantità di contrappeso Superlift richiesta per l'allestimento del braccio dipende dalla configurazione e dallo sbraccio del sistema Superlift.

La cantidad de contrapeso Superlift requerido para erigir el sistema de pluma depende de la configuración y el radio Superlift.

A quantidade de contrapesos do Superlift necessária para levantar o sistema da lança depende da configuração e do raio do Superlift.

Количество и вес противовесов Superlift, необходимых для установки системы стрелы, зависит от выбранной конфигурации и радиуса Superlift.

X without assisting equipment · ohne Zusatzausrüstung · sans équipement aditionnel · senza attrezzatura di supporto ·

sin equipamiento de asistencia · sem equipamento auxiliar · без вспомогательного оборудования















(X) with flex frame · mit Flex Frame Verstellrahmen · avec option Flex Frame · con Flex Frame · con Flex Frame · com Flex Frame · с системой Flex Frame

Erection / Lowering

PC 3800-1

Aufrichten / Ablegen · Montée / Placement · Montaggio / Calata ·
Erección / Descenso · Levantamento / Descida · Подъем / опускание

Erection / lowering of the PC 3800-1 boom systems to the ground · Aufrichten / Ablegen der PC 3800-1 Auslegersysteme · Montée / placement sur sol des systèmes de flèche de la PC 3800-1 · Montaggio / calata dei sistemi braccio PC 3800-1 a terra · Erección / descenso al terreno del sistema de pluma del PC 3800-1 · Levantamento / descida dos sistemas da lança do PC 3800-1 para o solo · Подъем / опускание системы стрелы крана PC 3800-1 на землю

Boom combination Auslegervariante Combinaison de flèche Combinazione braccio Combinación de pluma Combinação de lanças Комбинация стрелы	Fly jib (m) Hilfsausleger Fléchette Falcone Plumín Lança auxiliar Стрела с изменяемым вылетом	Main boom · Hauptausleger · Flèche principale · Braccio base · Pluma principal · Lança principal · Главная стрела																							
		m	36	42	48	54	60	66	72	78	84	90	96	102	108	114	120	126	132	138	144	150	156		
SSL_1			X	X	X	X	X	X	X	X	X	X	X	X	X	-	-	-	-	-	-	-	-	-	
LSL_1			-	-	-	-	-	X	X	X	X	X	X	X	X	-	-	-	-	-	-	-	-	-	
LSL_2			-	-	-	X	X	X	X	X	X	X	X	X	X	-	-	-	-	-	-	-	-	-	
SWSL_1 85° 	24																								
	30																								
	36																								
	42																								
	48																								
	54																								
	60																								
	66																								
	72																								
	78																								
84																									
90																									
96																									
SSL+LF_1 15°, 20°, 30° 	12		-	X	X	X	X	X	X	X	X	X	X	X	X	-	-	-	-	-	-	-	-	-	
	24		-	X	X	X	X	X	X	X	X	X	X	X	X	-	-	-	-	-	-	-	-	-	
	36		-	X	X	X	X	X	X	X	X	X	X	X	X	-	-	-	-	-	-	-	-	-	
LSL+LF_2 15°, 20°, 30° 	12		-	-	-	-	-	X	X	X	X	X	X	X	X	X	X	X	X	X	X	X	-	-	
	24		-	-	-	-	-	X	X	X	X	X	X	X	X	X	X	X	X	X	X	X	-	-	
	36		-	-	-	-	-	X	X	X	X	X	X	X	X	X	X	X	X	X	X	X	-	-	
LVSL_1 	12																								
		m	78	84	90	93	96	99	102	105	108	111	114	117	120-123	126-129	132-147	150-159	162-165	168	171				
LSL_5			-	-	-	-	-	-	-	-	-	-	X	X	X	X	X	X	-	-	-	-	-		
LSL_7			-	-	-	-	X	X	X	X	X	X	X	X	X	X	X	X	-	-	-	-	-		
LSL_9			-	-	-	-	-	X	X	X	X	X	X	X	X	X	X	X	(X)	-	-	-	-		
LSL_11			-	-	-	-	-	X	X	X	X	X	X	X	X	X	X	X	(X)	-	-	-	-		
LSL_13			-	-	-	-	-	-	-	-	-	-	-	-	X	X	X	X	(X)	(X)	(X)	-	-		
LSL_15			-	-	-	-	-	-	-	-	-	-	-	-	-	-	(X)	(X)	(X)	(X)	(X)	-	-		
LSL+LF_3 	12		X	X	X	-	X	-	X	-	X	X	X	X	X	X	X	X	-	-	-	-	-		
LSL+LF_4 	12		-	-	-	-	-	X	X	X	X	X	X	X	X	X	X	X	-	-	-	-	-		
LSL+LF_4 	24		-	-	-	-	-	X	X	X	X	X	X	X	X	X	X	X	-	-	-	-	-		
LSL+LF_6 	12		-	-	X	X	X	X	X	X	X	X	X	X	X	X	X	X	-	-	-	-	-		
LSL+LF_8 	12		-	-	-	-	X	X	X	X	X	X	X	X	X	X	X	X	-	-	-	-	-		
LSL+LF_10 	12		-	-	-	-	X	X	X	X	X	X	X	X	X	X	X	X	(X)	-	-	-	-		
LSL+LF_12 	12		-	-	-	-	-	-	-	-	-	-	X	X	X	X	X	X	(X)	-	-	-	-		
LSL+LF_14 	12		-	-	-	-	-	-	-	-	-	-	-	-	(X)	(X)	(X)	(X)	(X)	-	-	-	-		
LSL+LF_14 	18		-	-	-	-	-	-	-	-	-	-	-	-	(X)	(X)	(X)	(X)	(X)	-	-	-	-		
LSL+LF_14 	24		-	-	-	-	-	-	-	-	-	-	-	-	(X)	(X)	(X)	(X)	(X)	-	-	-	-		

see page 14 · siehe Seite 14 · voir page 14 · vedi pagina 14 · ver página 14 · ver página 14 · см. на стр. 14

Boom Combinations

PC 3800-1

Ausleger-Kombinationen · Combinaisons de flèche · Combinazioni braccio ·
 Combinaciones de pluma · Combinações de lanças · Комбинации стрелы

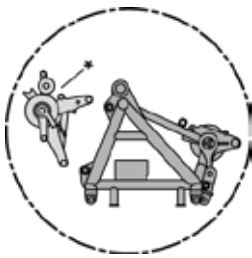

■ Typ 2824A

■ Typ 2420A

Runner
54 t



LH, LSL, SW, SWSL, LVSL

SH, SSL

* Attachable · Anbaubar · Amovible · Montabile · Acoplable ·
 Adaptável · Приставн

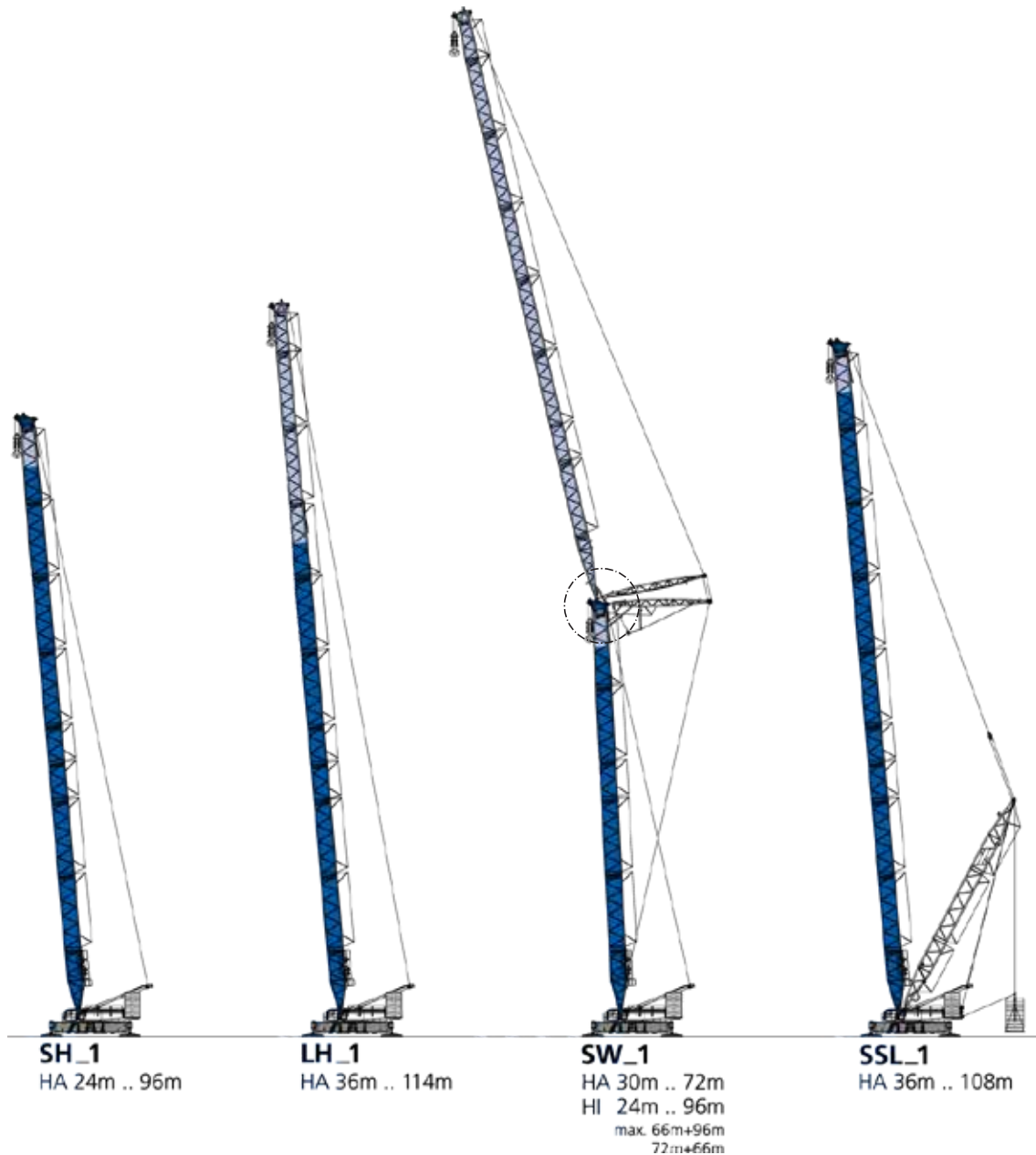

Boom Combinations

PC 3800-1

Ausleger-Kombinationen · Combinaisons de flèche · Combinazioni braccio ·
 Combinaciones de pluma · Combinações de lanças · Комбинации стрелы

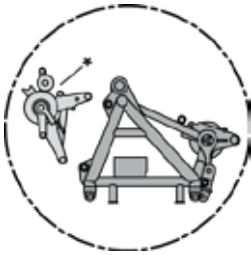

■ Typ 2824A

■ Typ 2420A

Runner
54 t



LH, LSL, SW, SWSL, LVSL

* Attachable · Anbaubar · Amovible · Montabile · Acoplable ·
 Adaptável · Приставн

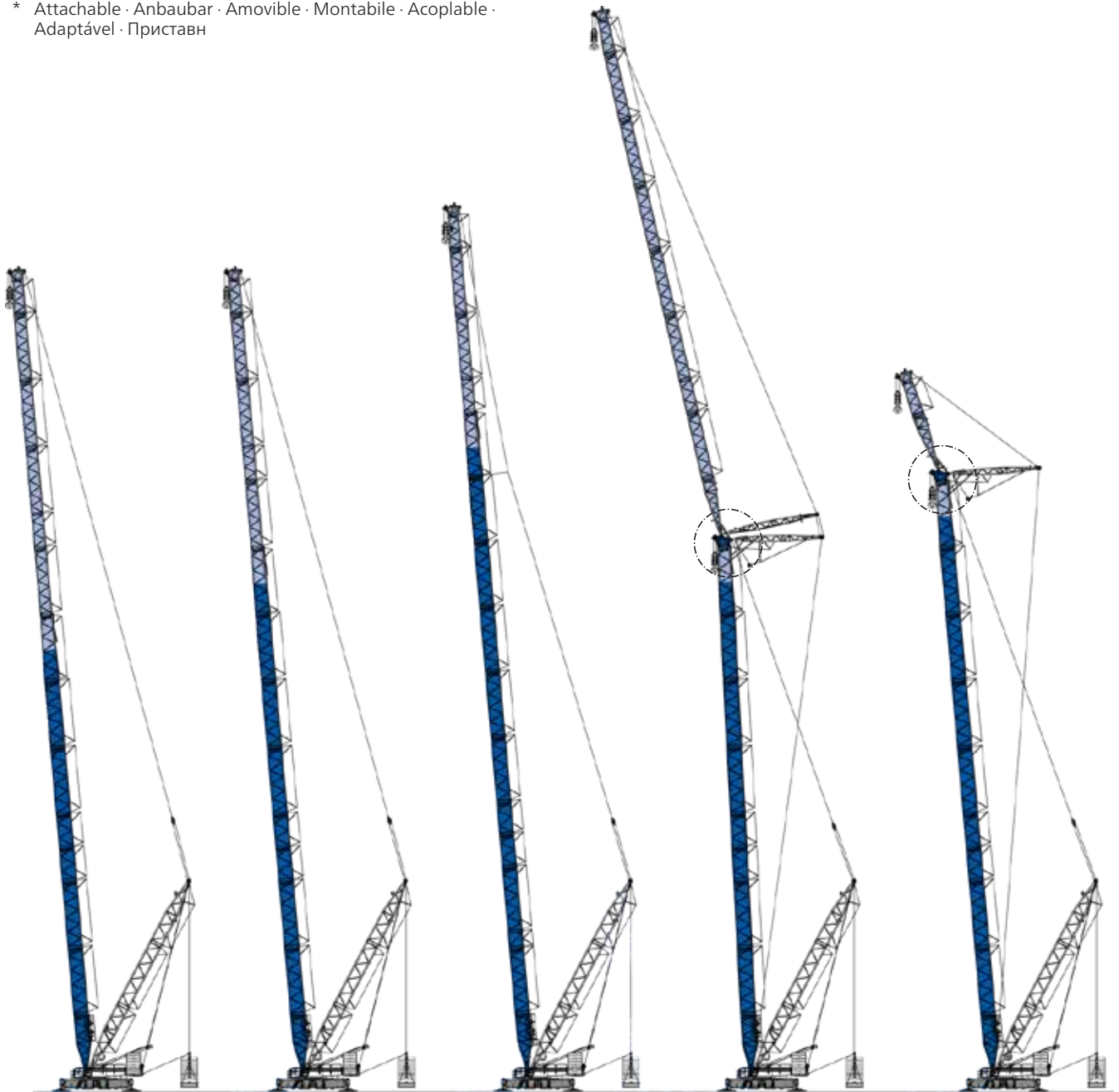

LSL_1
HA 72m .. 144m

LSL_2
HA 54m .. 144m

LSL_5
HA 114m .. 159m

SWSL_1
HA 36m .. 108m
 HI 24m .. 96m
 max. 96m+96m
 102m+90m
 108m+60m

LVSL_1
HA 36m .. 108m
 HI 18m

Boom Combinations

PC 3800-1

Ausleger-Kombinationen · Combinaisons de flèche · Combinazioni braccio ·
Combinaciones de pluma · Combinações de lanças · Комбинации стрелы

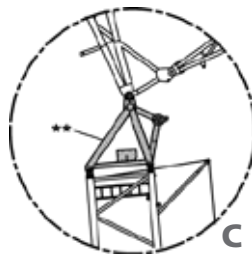
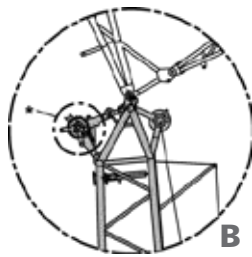
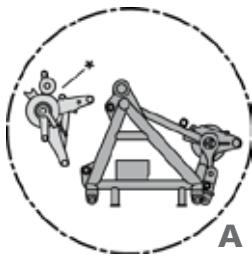

■ Typ 2824A

■ Typ 2420A



* Attachable · Anbaubar · Amovible · Montabile · Acoplable ·
Adaptável · Приставн

** Option · Option · En option · Opzione · Opcion ·
Opcional · Опция

Runner 18 t on LF standard
Runner (Montagespitze) Standard an LF
Potence 18 t de série sur LF · Runner da 18 t su LF
di serie · Runner 18 t en LF estándar
Ponta de montagem de 18 t padrão em LF
Подвижной блок 18 т на стреле LF,
стандартная комплектация

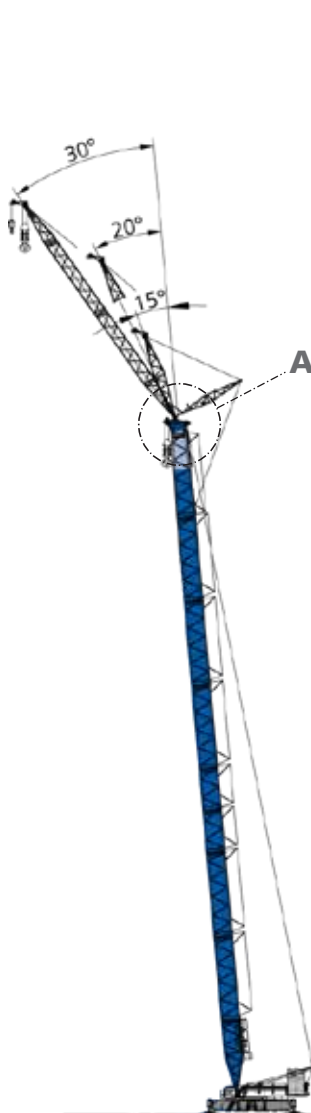

SH+LF_1

HA 30m .. 96m
HI 12m .. 36m
max. 84m + 36m
90m + 24m
96m + 12m

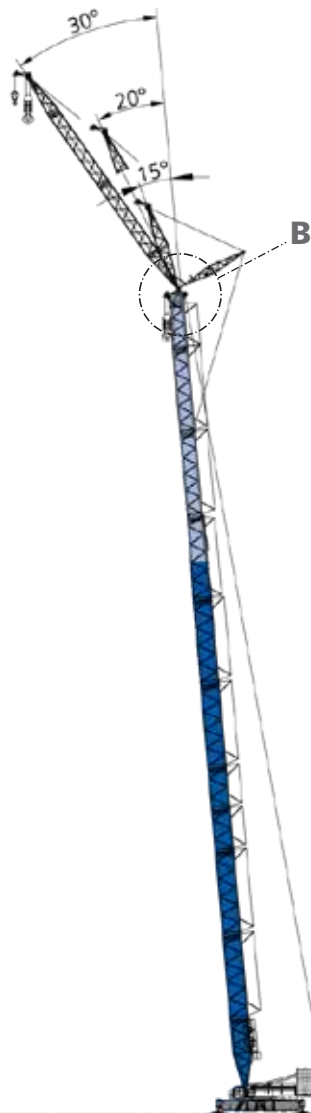

LH+LF_1

HA 48m .. 114m
HI 12m .. 36m
max. 102m + 36m
108m + 24m
114m + 12m

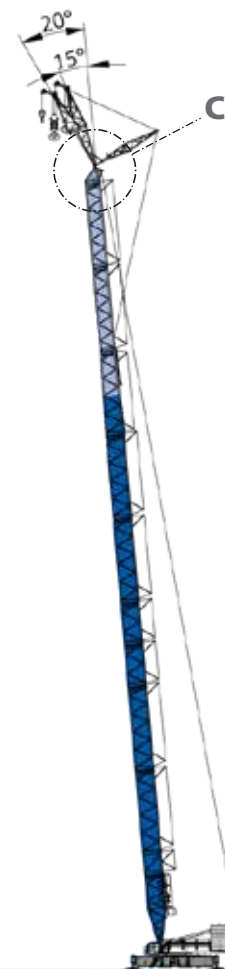

LH+LF_3

HA 72m .. 111m
HI 12m

Boom Combinations

PC 3800-1

Ausleger-Kombinationen · Combinaisons de flèche · Combinazioni braccio ·
 Combinaciones de pluma · Combinações de lanças · Комбинации стрелы

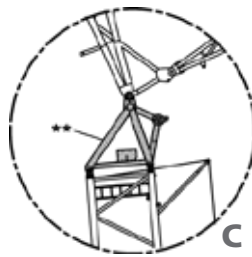
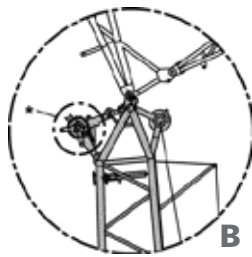
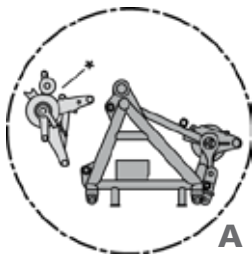

■ Typ 2824A

■ Typ 2420A



* Attachable · Anbaubar · Amovible · Montabile · Acoplable ·
 Adaptável · Приставн

** Option · Option · En option · Opzione · Opcion ·
 Opcional · Опция

Runner 18 t on LF standard
 siehe Seite 16
 voir page 16
 vedi pagina 16
 ver página 16
 см. на стр. 16

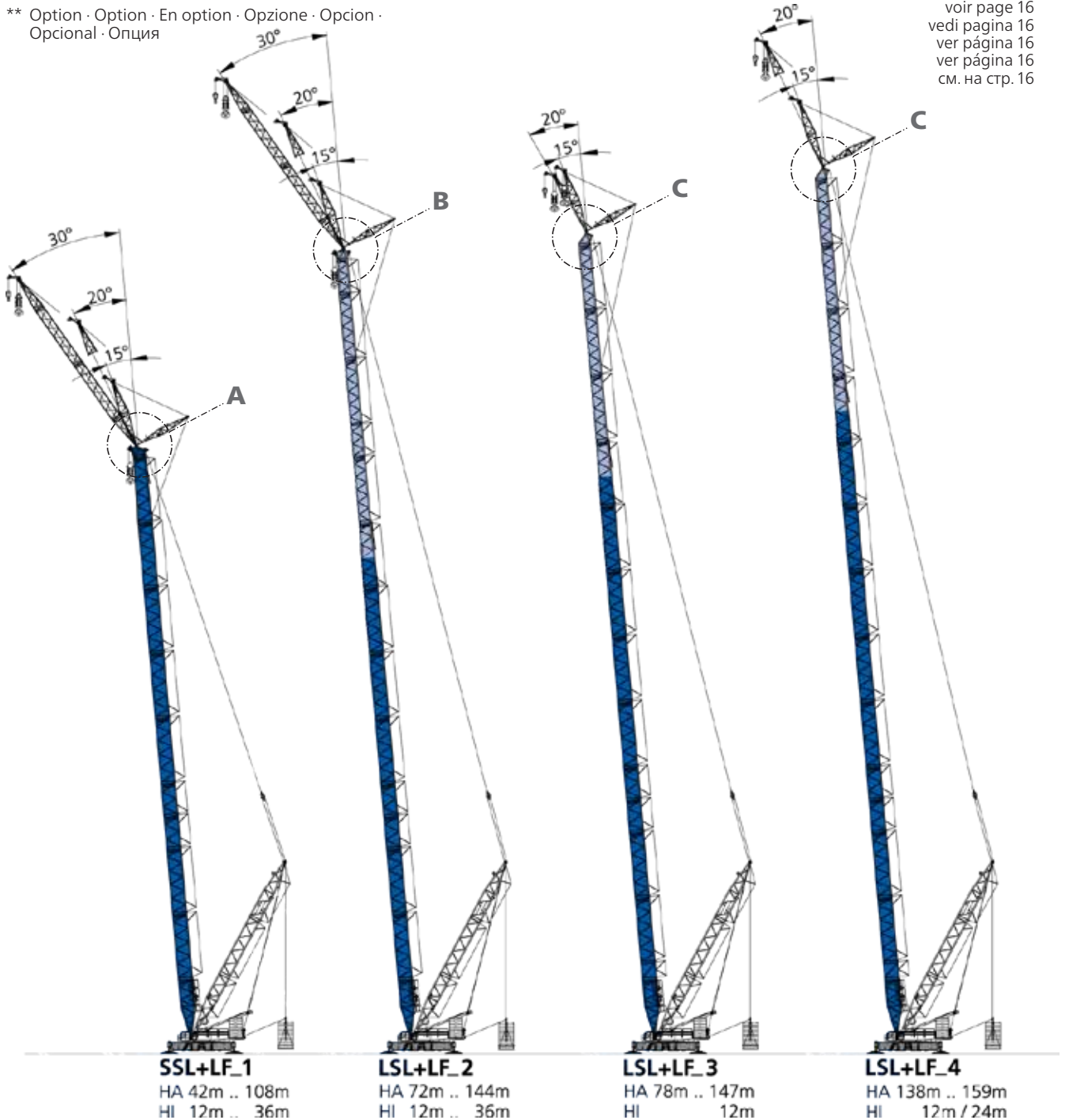

Boom Combinations

PC 3800-1

Ausleger-Kombinationen · Combinaisons de flèche · Combinazioni braccio ·
Combinaciones de pluma · Combinações de lanças · Комбинации стрелы

- Typ 3330A
- Typ 2824A
- Typ 2420A

Runner
54 t



LSL

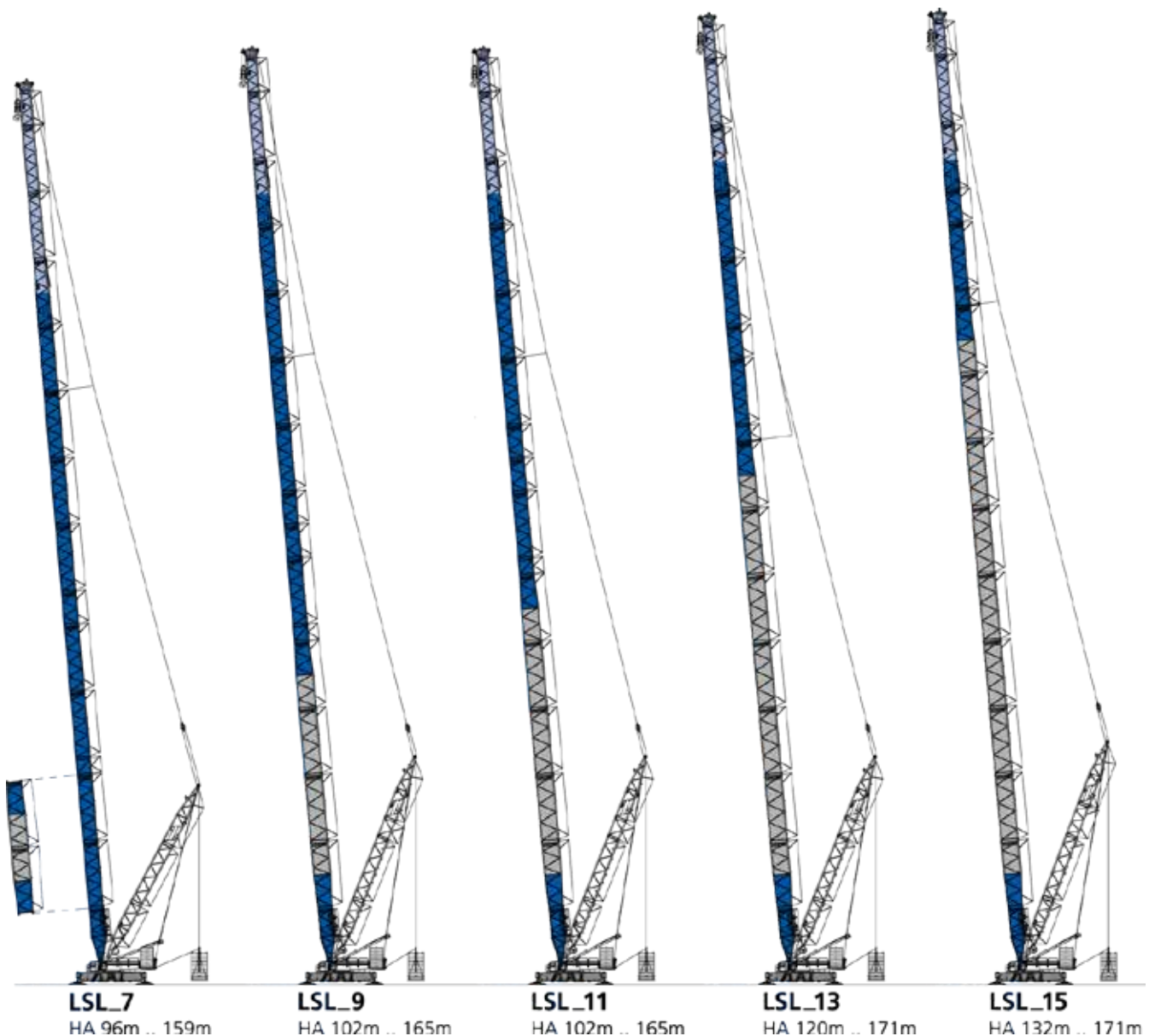

Boom Combinations

PC 3800-1

Ausleger-Kombinationen · Combinaisons de flèche · Combinazioni braccio ·
 Combinaciones de pluma · Combinações de lanças · Комбинации стрелы

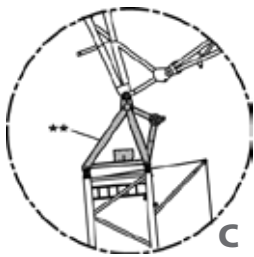

- Typ 3330A
- Typ 2824A
- Typ 2420A



** Option · Option · En option · Opzione · Opcion ·
 Opcional · Опция

Runner 18 t on LF standard
 Runner (Montagespitze) Standard an LF
 Potence 18 t de série sur LF · Runner da 18 t su LF
 di serie · Runner 18 t en LF estándar
 Ponta de montagem de 18 t padrão em LF
 Подвижной блок 18 т на стреле LF,
 стандартная комплектация

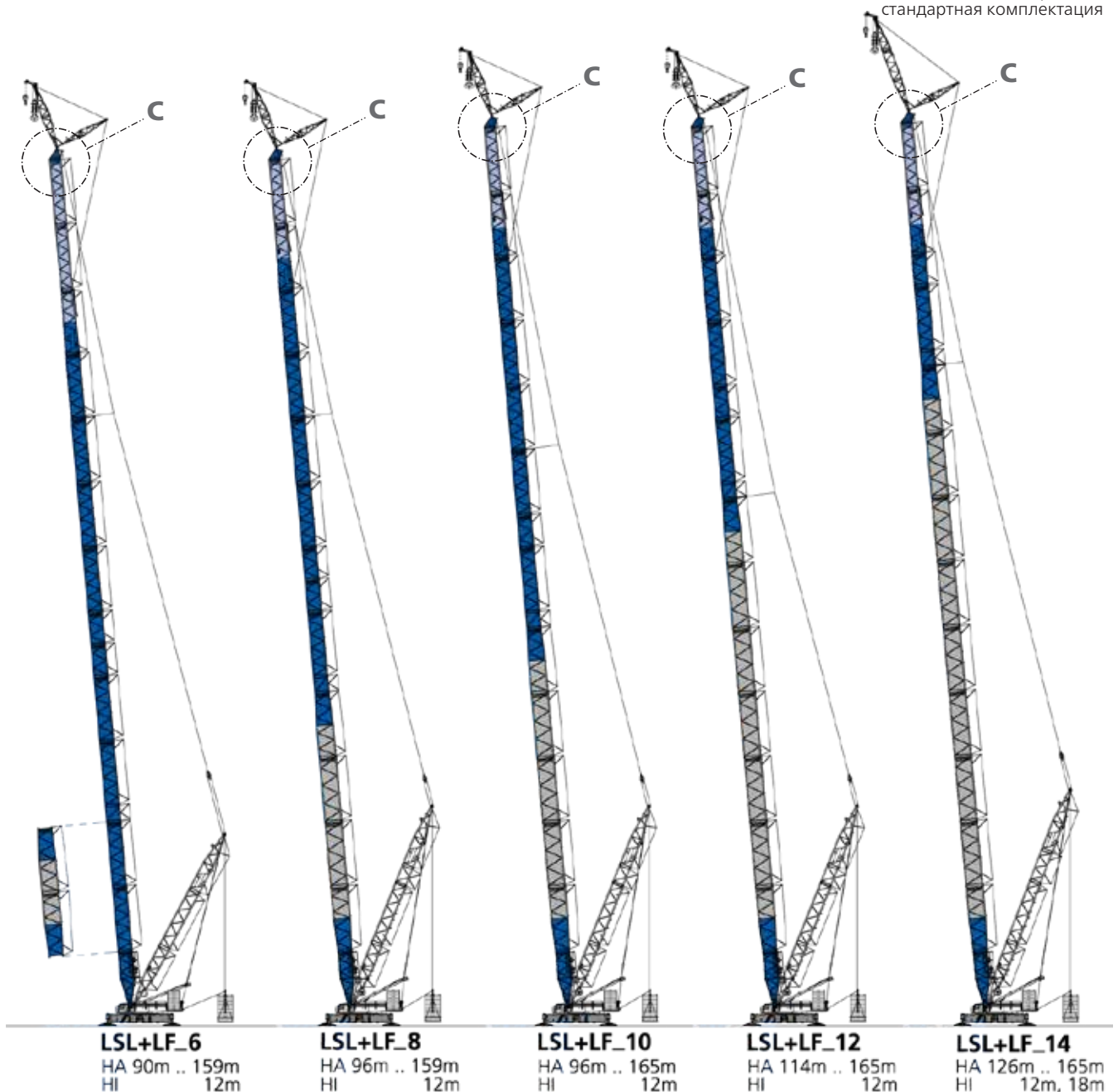

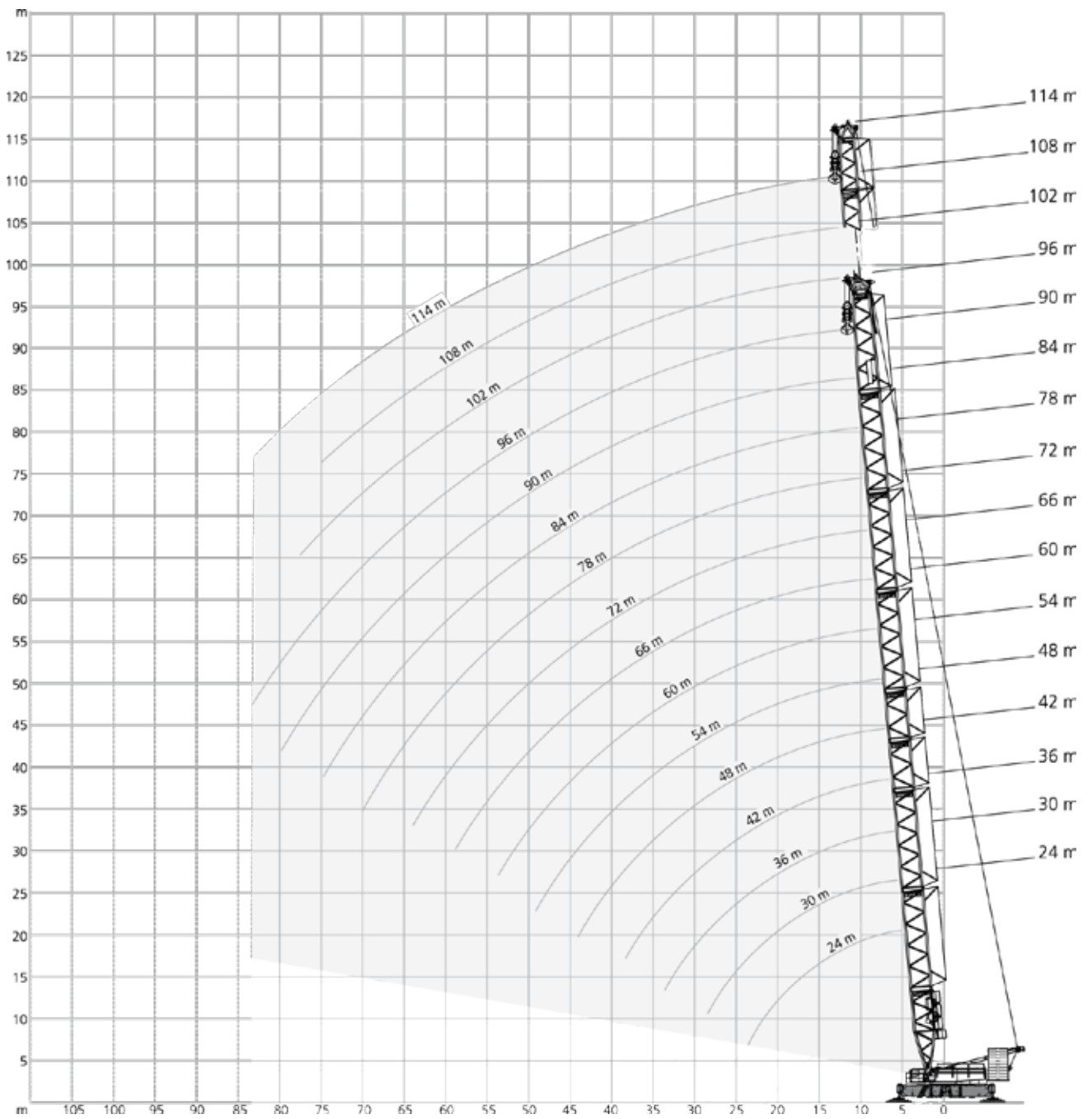

 9.8 m/s 360° ISO																		
SH_1																		
24 m			30 m			36 m			42 m			48 m			54 m			
12/12			14/14			16/16			12/12			14/14			16/16			
m	t	t	t	t	t	t	t	t	t	t	t	t	t	t	t	t	t	t
5,5	634,0	605,0	522,0	-	-	-	-	-	-	-	-	-	-	-	-	-	-	-
6	615,0	576,0	499,0	601,0	573,0	494,0	-	-	-	-	-	-	-	-	-	-	-	-
7	581,0	528,0	461,0	566,0	524,0	456,0	557,0	521,0	451,0	546,0	517,0	447,0	-	-	-	-	-	-
8	530,0	487,0	427,0	528,0	484,0	423,0	526,0	480,0	418,0	514,0	476,0	413,0	507,0	472,0	409,0	501,0	469,0	406,0
9	474,0	452,0	397,0	471,0	448,0	393,0	469,0	445,0	390,0	467,0	441,0	385,0	465,0	437,0	380,0	463,0	434,0	376,0
10	427,0	421,0	371,0	425,0	417,0	367,0	423,0	414,0	364,0	421,0	411,0	360,0	419,0	407,0	355,0	417,0	404,0	351,0
12	353,0	353,0	327,0	351,0	351,0	325,0	349,0	349,0	320,0	347,0	347,0	317,0	345,0	345,0	313,0	344,0	344,0	310,0
14	297,0	297,0	292,0	295,0	295,0	289,0	293,0	293,0	287,0	291,0	291,0	282,0	289,0	289,0	278,0	288,0	288,0	275,0
16	255,0	255,0	255,0	253,0	253,0	253,0	252,0	252,0	252,0	250,0	250,0	250,0	248,0	248,0	248,0	246,0	246,0	246,0
18	217,0	224,0	224,0	216,0	222,0	222,0	215,0	220,0	220,0	214,0	218,0	218,0	214,0	216,0	216,0	213,0	215,0	215,0
20	183,0	199,0	199,0	183,0	197,0	197,0	182,0	195,0	195,0	181,0	193,0	193,0	180,0	191,0	191,0	179,0	190,0	190,0
22	159,0	178,0	178,0	158,0	176,0	176,0	157,0	174,0	174,0	156,0	172,0	172,0	155,0	171,0	171,0	154,0	169,0	169,0
23	148,0	169,0	169,0	148,0	168,0	168,0	147,0	166,0	166,0	146,0	163,5	163,5	145,0	162,5	162,5	144,0	160,5	160,5
24	-	-	-	138,0	160,0	160,0	137,0	158,0	158,0	136,0	155,0	155,0	135,0	154,0	154,0	134,0	152,0	152,0
26	-	-	-	123,0	145,0	145,0	122,0	143,0	143,0	120,0	141,0	141,0	119,0	139,0	139,0	118,0	138,0	138,0
28	-	-	-	110,0	130,0	132,0	109,0	129,0	131,0	108,0	127,0	129,0	107,0	127,0	128,0	106,0	125,0	125,0
30	-	-	-	-	-	-	98,5	116,0	120,0	97,0	115,0	118,0	96,0	114,0	117,0	95,0	113,0	115,0
33	-	-	-	-	-	-	86,0	101,0	106,0	84,6	100,0	104,5	83,6	99,0	103,5	82,6	98,0	101,8
34	-	-	-	-	-	-	-	-	-	80,5	95,0	100,0	79,5	94,0	99,0	78,5	93,0	97,5
38	-	-	-	-	-	-	-	-	-	68,5	80,5	86,0	67,0	79,5	84,5	65,5	78,0	83,0
42	-	-	-	-	-	-	-	-	-	-	-	-	57,5	68,0	73,5	56,0	66,5	72,0
44	-	-	-	-	-	-	-	-	-	-	-	-	53,5	63,5	68,5	52,3	62,2	67,2
46	-	-	-	-	-	-	-	-	-	-	-	-	-	-	-	48,7	58,0	62,5
49	-	-	-	-	-	-	-	-	-	-	-	-	-	-	-	44,0	52,5	56,5

65 t
105 t
145 t
185 t
225 t

12 m x 12 m
14 m x 14 m
16 m x 16 m

9.8 m/s																		360°				ISO	
SH_1																							
60 m			66 m			72 m			78 m			84 m			90 m			96 m					
12/12			14/14			16/16			12/12			14/14			16/16			14/14			16/16		
m	t	t	t	t	t	t	t	t	t	t	t	t	t	t	t	t	t	t	m				
9	461,0	429,0	372,0	-	-	-	-	-	-	-	-	-	-	-	-	-	-	-	9				
10	415,0	398,0	347,0	402,0	395,0	344,0	350,0	350,0	341,0	-	-	-	-	-	-	-	-	-	10				
11	378,5	370,0	325,0	365,5	368,0	323,0	332,5	341,5	319,5	288,0	288,0	253,0	253,0	-	-	-	-	-	11				
12	342,0	342,0	303,0	329,0	341,0	302,0	315,0	333,0	298,0	282,0	282,0	248,0	248,0	218,0	218,0	191,0	191,0	12					
14	284,0	286,0	271,0	273,0	285,0	268,0	262,0	284,0	264,0	263,0	262,0	237,0	237,0	209,0	209,0	183,0	183,0	14					
16	241,0	245,0	244,0	233,0	244,0	241,0	224,0	242,0	237,0	238,0	235,0	220,0	220,0	199,0	199,0	175,0	175,0	16					
18	208,0	213,0	213,0	201,0	212,0	212,0	194,0	210,0	210,0	208,0	208,0	201,0	201,0	189,0	189,0	165,0	165,0	18					
20	179,0	188,0	188,0	177,0	187,0	187,0	171,0	185,0	185,0	183,0	183,0	177,0	177,0	170,0	170,0	155,0	155,0	20					
22	153,0	168,0	168,0	153,0	167,0	167,0	152,0	165,0	165,0	162,0	162,0	157,0	157,0	151,0	151,0	142,0	142,0	22					
24	133,0	151,0	151,0	133,0	150,0	150,0	132,0	148,0	148,0	146,0	146,0	140,0	140,0	135,0	135,0	129,0	129,0	24					
26	118,0	136,0	136,0	117,0	135,0	135,0	116,0	134,0	134,0	132,0	132,0	127,0	127,0	122,0	122,0	117,0	117,0	26					
28	105,0	123,0	123,0	104,0	122,0	122,0	103,0	121,0	121,0	119,0	119,0	115,0	115,0	111,0	111,0	106,0	106,0	28					
30	94,0	112,0	112,0	93,5	111,0	111,0	92,5	109,0	109,0	108,0	108,0	105,0	105,0	101,0	101,0	96,5	96,5	30					
34	77,0	92,0	96,0	76,5	91,5	93,5	75,5	90,5	91,5	90,0	90,5	87,5	87,5	84,5	84,5	80,5	80,5	34					
38	64,5	77,0	81,5	64,0	76,5	80,5	62,5	75,5	77,5	75,0	76,5	73,5	74,0	71,0	71,0	67,5	67,5	38					
42	55,0	65,5	70,0	54,0	65,0	69,5	53,0	63,5	67,5	63,0	66,5	62,0	63,5	61,0	61,0	57,0	57,0	42					
46	47,2	56,5	61,0	46,5	56,0	60,0	45,2	54,5	58,0	54,0	57,5	52,5	55,5	52,5	53,0	49,4	49,4	46					
50	41,0	49,3	53,0	40,1	48,6	52,0	38,4	47,2	50,5	46,7	49,7	45,3	47,9	45,0	46,3	43,0	43,0	50					
54	35,6	43,4	46,7	34,6	42,6	45,9	32,8	40,9	44,0	40,2	43,2	38,7	41,4	38,4	39,9	37,0	37,1	54					
58	-	-	-	30,0	37,4	40,3	28,1	35,5	38,3	34,7	37,6	33,1	35,7	32,9	34,2	31,4	31,7	58					
59	-	-	-	29,0	36,2	39,0	27,1	34,3	37,0	33,5	36,3	31,9	34,5	31,7	32,9	30,2	30,4	59					
62	-	-	-	-	-	-	24,2	30,9	33,5	30,1	32,7	28,5	30,9	28,1	29,2	26,7	26,8	62					
64	-	-	-	-	-	-	22,4	28,9	31,3	28,1	30,6	26,4	28,7	26,1	27,0	24,5	24,6	64					
66	-	-	-	-	-	-	-	-	-	26,2	28,5	24,4	26,6	24,1	24,8	22,4	22,4	66					
70	-	-	-	-	-	-	-	-	-	22,8	24,8	21,0	22,9	20,6	21,1	18,5	18,5	70					
74	-	-	-	-	-	-	-	-	-	-	-	18,0	19,6	17,6	18,1	15,1	15,1	74					
75	-	-	-	-	-	-	-	-	-	-	-	17,3	18,9	16,9	17,5	14,3	14,3	75					
78	-	-	-	-	-	-	-	-	-	-	-	-	-	14,9	15,7	12,2	12,2	78					
80	-	-	-	-	-	-	-	-	-	-	-	-	-	13,8	14,8	11,0	10,9	80					
82	-	-	-	-	-	-	-	-	-	-	-	-	-	-	-	9,8	9,8	82					
85	-	-	-	-	-	-	-	-	-	-	-	-	-	-	-	8,3	8,3	85					

65 t 105 t 145 t 185 t 225 t

12 m x 12 m
14 m x 14 m
16 m x 16 m

78 m – 90 m:

Lifting capacities for outrigger bases not listed (12 x 12 m, 14 x 14 m) are always lower than all other values or the boom length cannot be erected (see overview page 14).

Tragfähigkeiten für nicht gelistete Stützbasen 12 m x 12 m bzw. 14 m x 14 m sind immer kleiner als alle übrigen Werte oder Länge nicht aufrichtbar (siehe Übersicht Seite 14).

Les capacités de levage pour les surfaces de calage non répertoriées (12 x 12 m, 14 x 14 m) sont toujours inférieures aux autres valeurs sinon impossibilité d'ériger la longueur de flèche (voir aperçu page 14).

Le capacità di sollevamento per basi stabilizzatori non indicate (12 x 12 m, 14 x 14 m) sono sempre inferiori a tutti gli altri valori o la lunghezza del braccio non può essere utilizzata (vedere panoramica a pagina 14).

Las capacidades de elevación para bases de estabilización no listadas (12 x 12 m, 14 x 14 m) son siempre más bajas que todos los otros valores o la longitud de pluma no puede ser levantada (véase vista general en la pág. 14).

Capacidades de içamento para bases do estabilizador não indicadas (12 x 12 m, 14 x 14 m) são sempre inferiores a todas as outras ou o comprimento da lança não poderá ser erguido (ver visão geral na página 14).

Грузоподъемность для площадей опор, не указанных в списке данных (12 x 12 м, 14 x 14 м), всегда ниже всех других значений, иначе стрела, указанной длины не может быть установлена (см. сводку на стр. 14).

9.8 m/s 360° ISO											
LH_1											
36 m		42 m		48 m		54 m		60 m			
14/14		16/16		14/14		16/16		14/14		16/16	
m	t	t	t	t	t	t	t	t	t	t	m
7	347,0	347,0	347,0	347,0	-	-	-	-	-	-	7
8	347,0	347,0	347,0	347,0	347,0	347,0	347,0	347,0	347,0	-	8
9	347,0	347,0	347,0	347,0	347,0	347,0	347,0	347,0	347,0	347,0	9
10	347,0	347,0	347,0	347,0	347,0	347,0	341,0	341,0	347,0	347,0	10
12	347,0	324,0	347,0	321,0	328,0	320,0	307,0	307,0	338,0	312,0	12
14	298,0	291,0	296,0	286,0	289,0	285,0	267,0	267,0	293,0	279,0	14
16	257,0	257,0	255,0	255,0	255,0	255,0	235,0	235,0	252,0	250,0	16
18	225,0	225,0	223,0	223,0	223,0	223,0	210,0	210,0	220,0	220,0	18
20	200,0	200,0	198,0	198,0	198,0	198,0	188,0	188,0	195,0	195,0	20
22	179,0	179,0	177,0	177,0	178,0	178,0	169,0	169,0	174,0	174,0	22
24	162,0	162,0	160,0	160,0	161,0	161,0	153,0	153,0	157,0	157,0	24
26	148,0	148,0	146,0	146,0	147,0	147,0	140,0	140,0	143,0	143,0	26
28	133,0	136,0	131,0	134,0	132,0	135,0	129,0	129,0	130,0	130,0	28
30	120,0	125,0	119,0	123,0	119,0	124,0	118,0	119,0	117,0	119,0	30
33	104,0	110,0	104,0	109,5	104,3	110,5	103,3	106,2	102,3	107,0	33
34	-	-	99,0	105,0	99,5	106,0	98,5	102,0	97,5	103,0	34
38	-	-	84,5	90,5	85,0	92,0	83,5	87,0	82,5	88,5	38
42	-	-	-	-	73,5	80,5	72,0	75,5	71,0	77,5	42
43	-	-	-	-	71,5	78,0	69,7	73,1	68,7	75,1	43
46	-	-	-	-	-	-	63,0	66,0	62,0	68,0	46
49	-	-	-	-	-	-	57,5	61,5	56,3	62,3	49
50	-	-	-	-	-	-	-	-	54,5	60,5	50
54	-	-	-	-	-	-	-	-	49,0	54,0	54

25 t
65 t
105 t
145 t
185 t
225 t

14 m x 14 m
16 m x 16 m

9.8 m/s													360°		ISO
LH 1															
	66 m		72 m		78 m	84 m	90 m	96 m	102 m	108 m	114 m				
	14/14	16/16	14/14												
m	t	t	t	t	t	t	t	t	t	t	t	t	m		
9	323,0	323,0	-	-	-	-	-	-	-	-	-	-	9		
10	320,0	320,0	291,0	291,0	265,0	-	-	-	-	-	-	-	10		
11	316,5	315,0	288,0	288,0	262,0	213,0	196,0	-	-	-	-	-	11		
12	313,0	310,0	285,0	285,0	259,0	207,0	192,0	163,0	149,0	-	-	-	12		
13	302,0	292,5	280,5	279,5	255,0	201,5	188,0	160,0	146,5	138,0	126,0	-	13		
14	291,0	275,0	276,0	274,0	251,0	196,0	184,0	157,0	144,0	136,0	124,0	-	14		
16	250,0	247,0	249,0	246,0	242,0	185,0	175,0	152,0	139,0	133,0	121,0	-	16		
18	218,0	218,0	217,0	217,0	214,0	174,0	167,0	146,0	134,0	130,0	118,0	-	18		
20	193,0	193,0	192,0	192,0	188,0	163,0	159,0	141,0	129,0	127,0	115,0	-	20		
22	172,0	172,0	171,0	171,0	168,0	153,0	151,0	135,0	124,0	124,0	111,0	-	22		
24	155,0	155,0	154,0	154,0	152,0	143,0	141,0	130,0	119,0	119,0	107,0	-	24		
26	141,0	141,0	140,0	140,0	138,0	133,0	130,0	123,0	114,0	115,0	103,0	-	26		
28	128,0	128,0	127,0	127,0	125,0	122,0	120,0	116,0	108,0	109,0	99,0	-	28		
30	116,0	117,0	116,0	116,0	114,0	113,0	110,0	107,0	102,0	100,0	93,0	-	30		
34	96,0	99,0	95,5	98,0	96,0	96,5	93,5	91,5	87,5	85,0	80,5	-	34		
38	81,0	86,5	80,5	84,0	82,0	82,5	80,0	78,0	75,0	72,5	69,0	-	38		
42	69,5	75,0	69,0	74,0	72,5	71,0	69,0	67,5	64,5	62,5	59,0	-	42		
46	60,5	66,0	59,5	64,5	63,0	63,0	59,5	59,0	56,0	53,5	51,0	-	46		
50	53,0	58,0	52,5	57,0	55,5	55,5	53,0	51,5	49,5	47,2	44,1	-	50		
54	47,2	51,5	46,4	50,5	49,0	48,9	46,7	46,1	44,0	41,8	38,7	-	54		
58	42,3	46,3	41,3	45,2	43,4	43,3	41,1	40,5	38,4	37,1	33,9	-	58		
59	41,1	45,1	40,2	44,0	42,2	42,1	39,9	39,2	37,1	35,9	32,6	-	59		
62	-	-	37,0	40,4	38,6	38,5	36,3	35,6	33,5	32,3	29,9	-	62		
64	-	-	35,1	38,3	36,5	36,4	34,2	33,5	31,3	30,1	27,8	-	64		
66	-	-	-	-	34,4	34,3	32,1	31,4	29,3	28,0	25,7	-	66		
69	-	-	-	-	31,6	31,5	29,3	28,6	26,5	25,2	22,8	-	69		
70	-	-	-	-	-	30,6	28,4	27,7	25,6	24,3	21,9	-	70		
74	-	-	-	-	-	27,3	25,2	24,4	22,3	20,9	18,6	-	74		
75	-	-	-	-	-	26,6	24,4	23,6	21,5	20,2	17,8	-	75		
78	-	-	-	-	-	-	22,3	21,5	19,4	18,0	15,7	-	78		
80	-	-	-	-	-	-	21,0	20,1	18,0	16,6	14,3	-	80		
82	-	-	-	-	-	-	-	18,9	16,7	15,3	13,0	-	82		
85	-	-	-	-	-	-	-	17,1	14,9	13,5	11,0	-	85		
86	-	-	-	-	-	-	-	-	14,4	12,9	10,4	-	86		
90	-	-	-	-	-	-	-	-	12,3	10,8	8,0	-	90		
94	-	-	-	-	-	-	-	-	-	8,8	5,9	-	94		
95	-	-	-	-	-	-	-	-	-	8,3	5,4	-	95		
98	-	-	-	-	-	-	-	-	-	-	4,1	-	98		

25 t 65 t 105 t 145 t 185 t 225 t

14 m x 14 m
16 m x 16 m

78 m – 90 m:

Lifting capacities for outrigger bases not listed (12 x 12 m, 14 x 14 m) are always lower than all other values or the boom length cannot be erected (see overview page 14).

Tragfähigkeiten für nicht gelistete Stützbasen 12 m x 12 m bzw. 14 m x 14 m sind immer kleiner als alle übrigen Werte oder Länge nicht aufrichtbar (siehe Übersicht Seite 14).

Les capacités de levage pour les surfaces de calage non répertoriées (12 x 12 m, 14 x 14 m) sont toujours inférieures aux autres valeurs sinon impossibilité d'ériger la longueur de flèche (voir aperçu page 14).

Le capacità di sollevamento per basi stabilizzatori non indicate (12 x 12 m, 14 x 14 m) sono sempre inferiori a tutti gli altri valori o la lunghezza del braccio non può essere utilizzata (vedere panoramica a pagina 14).

Las capacidades de elevación para bases de estabilización no listadas (12 x 12 m, 14 x 14 m) son siempre más bajas que todos los otros valores o la longitud de pluma no puede ser levantada (véase vista general en la pág. 14).

Capacidades de içamento para bases do estabilizador não indicadas (12 x 12 m, 14 x 14 m) são sempre inferiores a todas as outras ou o comprimento da lança não poderá ser erguido (ver visão geral na página 14).

Грузоподъемность для площадей опор, не указанных в списке данных (12 x 12 м, 14 x 14 м), всегда ниже всех других значений, иначе стрела, указанной длины не может быть установлена (см. сводку на стр. 14).

Notes

PC 3800-1

Notizen · Notes · Nota · Notas · Notas ·
пометы, комментарии, примечания

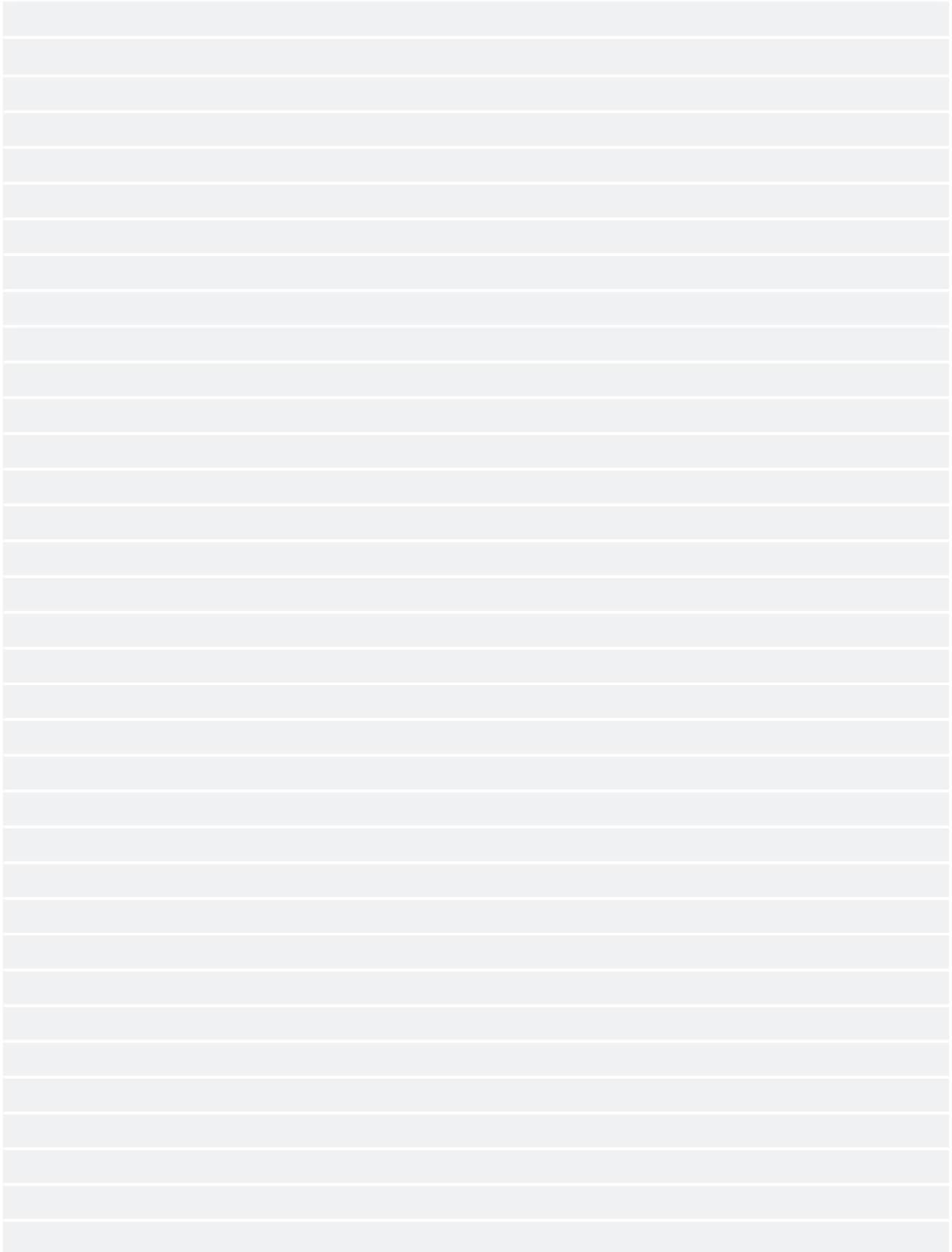

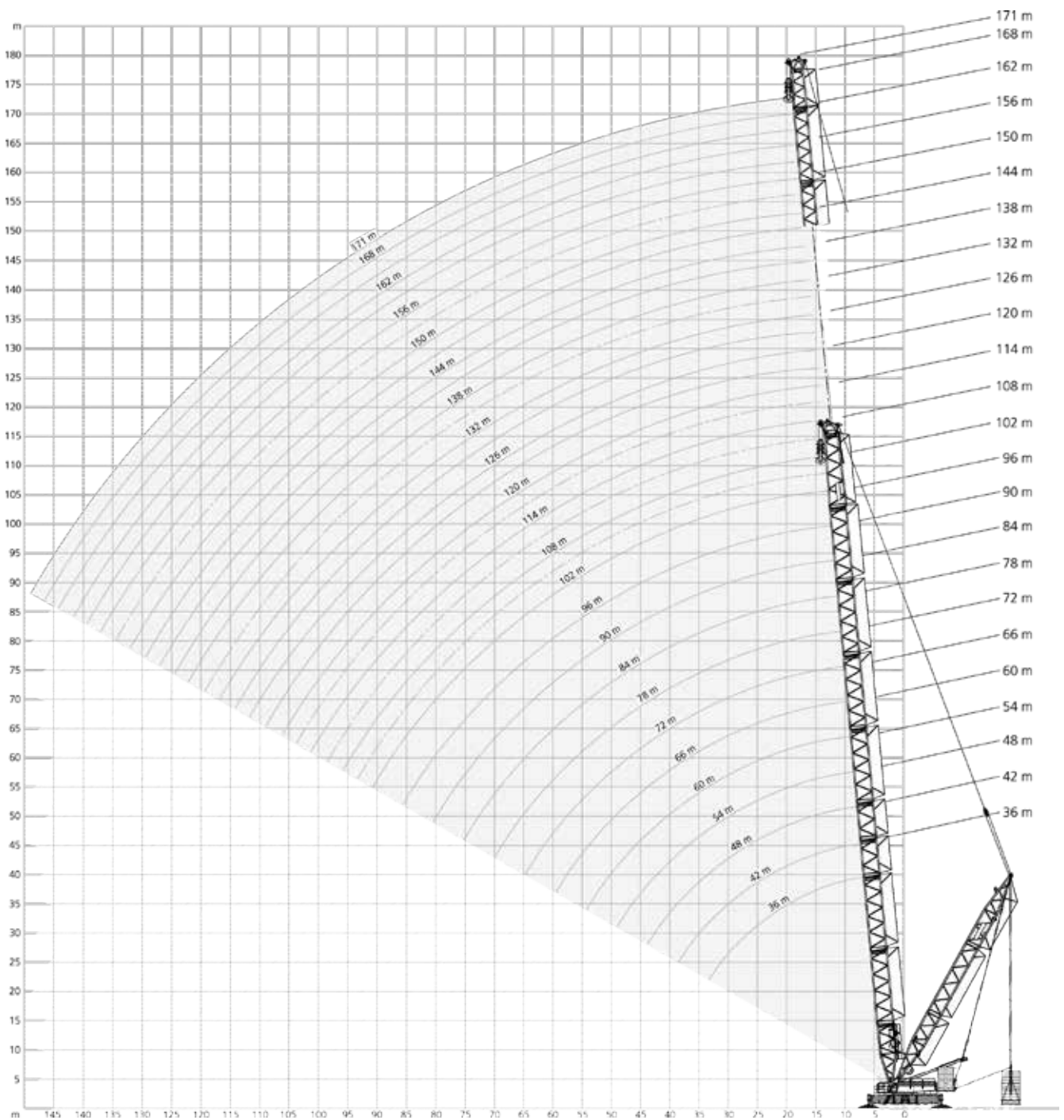

225 t		11-19 m				12 m x 12 m				9.8 m/s		360°		ISO	
36 m		42 m		48 m		54 m		60 m		66 m		72 m		SSL_1	
0 t		0t-325t		0 t		0t-325t		0 t		0t-325t		0 t		0t-325t	
m	t	t	t	t	t	t	t	t	t	t	t	t	t	t	m
7	613,0	650,0	610,0	650,0	-	-	-	-	-	-	-	-	-	-	7
8	546,0	650,0	543,0	650,0	540,0	650,0	538,0	650,0	-	-	-	-	-	-	8
9	487,0	650,0	484,0	650,0	482,0	650,0	479,0	650,0	476,0	571,0	-	-	-	-	9
10	434,0	650,0	432,0	650,0	431,0	650,0	429,0	650,0	429,0	571,0	428,0	509,0	424,0	445,0	10
12	341,0	637,0	340,0	631,0	338,0	627,0	336,0	622,0	335,0	571,0	337,0	509,0	338,0	445,0	12
14	280,0	593,0	278,0	589,0	276,0	582,0	274,0	580,0	273,0	571,0	274,0	509,0	274,0	445,0	14
16	236,0	540,0	234,0	537,0	232,0	534,0	230,0	532,0	228,0	529,0	229,0	506,0	229,0	445,0	16
18	203,0	488,0	201,0	486,0	199,0	483,0	197,0	481,0	195,0	478,0	196,0	478,0	195,0	445,0	18
20	177,0	439,0	175,0	437,0	173,0	434,0	171,0	432,0	169,0	429,0	170,0	429,0	169,0	427,0	20
22	160,0	391,0	155,0	396,0	153,0	393,0	151,0	391,0	149,0	389,0	149,0	388,0	148,0	386,0	22
24	143,0	344,0	141,0	362,0	136,0	359,0	134,0	357,0	132,0	355,0	132,0	354,0	131,0	352,0	24
26	128,0	312,0	126,0	333,0	122,0	331,0	120,0	328,0	118,0	326,0	118,0	325,0	117,0	324,0	26
28	117,0	278,0	114,0	306,0	112,0	306,0	108,0	303,0	106,0	301,0	106,0	300,0	105,0	299,0	28
30	106,0	250,0	104,0	275,0	102,0	284,0	100,0	282,0	96,0	279,0	96,0	279,0	94,5	277,0	30
33	94,0	211,0	92,7	238,0	90,5	255,0	88,2	256,0	85,2	254,0	85,0	253,5	82,7	252,0	33
34	-	-	89,0	227,6	86,6	245,3	84,3	247,3	81,6	245,6	81,3	245,0	78,8	243,6	34
38	-	-	75,5	190,0	73,6	207,3	71,1	216,3	69,0	216,0	68,5	215,3	66,0	214,3	38
42	-	-	-	-	63,0	176,0	60,5	189,0	58,0	190,0	57,5	190,0	56,0	189,0	42
44	-	-	-	-	59,0	159,0	56,7	174,6	54,1	180,0	53,6	180,6	52,0	179,6	44
46	-	-	-	-	-	-	53,0	160,3	50,3	170,0	49,7	171,3	48,0	170,3	46
49	-	-	-	-	-	-	47,7	144,0	45,0	154,3	44,4	158,1	42,5	157,3	49
50	-	-	-	-	-	-	-	-	43,6	148,6	42,9	154,3	41,0	153,6	50
54	-	-	-	-	-	-	-	-	37,9	131,0	36,9	139,0	34,9	139,0	54
58	-	-	-	-	-	-	-	-	-	-	32,2	119,8	30,1	126,3	58
59	-	-	-	-	-	-	-	-	-	-	31,1	117,0	28,9	123,1	59
62	-	-	-	-	-	-	-	-	-	-	-	-	25,9	112,0	62
64	-	-	-	-	-	-	-	-	-	-	-	-	24,0	104,0	64

0 t
65 t
125 t
165 t
205 t
245 t
285 t
325 t

225 t		11-19 m				12 m x 12 m				9.8 m/s		360°		ISO
		78 m		84 m		90 m		96 m		102 m		108 m		
		SSL_1												
		0 t	0t-325t	0 t	0t-325t	0 t	0t-325t	0 t	0t-325t	0 t	0t-325t	0 t	0t-325t	
m	t	t	t	t	t	t	t	t	t	t	t	t	t	m
11	365,0	387,0	330,0	348,0	-	-	-	-	-	-	-	-	-	11
12	341,0	387,0	322,0	348,0	293,0	310,0	260,0	274,0	-	-	-	-	-	12
13	309,0	387,0	298,0	348,0	275,0	310,0	254,0	274,0	230,0	243,0	204,0	214,0	-	13
14	277,0	387,0	276,0	348,0	267,0	310,0	253,0	274,0	230,0	243,0	204,0	214,0	-	14
16	231,0	387,0	230,0	348,0	231,0	310,0	223,0	274,0	215,0	243,0	201,0	214,0	-	16
18	197,0	381,0	196,0	347,0	197,0	310,0	196,0	274,0	189,0	243,0	183,0	214,0	-	18
20	170,0	378,0	169,0	341,0	170,0	308,0	169,0	274,0	168,0	243,0	163,0	214,0	-	20
22	149,0	375,0	148,0	338,0	148,0	304,0	147,0	272,0	147,0	242,0	146,0	213,0	-	22
24	132,0	352,0	130,0	335,0	131,0	303,0	130,0	269,0	129,0	240,0	129,0	210,0	-	24
26	117,0	323,0	116,0	322,0	116,0	300,0	115,0	268,0	114,0	238,0	114,0	207,0	-	26
28	105,0	299,0	104,0	297,0	104,0	289,0	103,0	265,0	102,0	236,0	101,0	205,0	-	28
30	95,0	277,0	93,5	275,0	94,0	275,0	92,5	256,0	91,5	233,0	90,5	203,0	-	30
34	79,3	243,0	77,5	241,0	78,0	241,0	76,5	233,6	75,5	218,0	74,1	194,0	-	34
38	66,3	214,0	64,0	212,0	64,3	212,0	62,8	210,6	61,8	203,6	60,4	186,3	-	38
42	56,0	190,0	53,0	188,0	53,0	188,0	51,5	186,0	50,5	185,0	49,4	179,0	-	42
46	48,0	170,6	45,8	169,3	45,9	169,3	43,5	167,3	42,3	167,0	41,0	163,6	-	46
50	40,9	153,6	39,0	152,6	39,2	152,6	36,7	151,0	35,4	150,6	33,7	149,0	-	50
54	34,7	139,0	32,8	138,0	32,9	138,0	31,1	137,0	29,8	136,0	27,3	135,0	-	54
58	29,9	127,6	27,8	126,0	27,9	126,6	26,1	125,0	24,8	124,6	22,9	123,6	-	58
62	25,5	116,6	23,4	115,3	23,4	116,0	21,6	114,3	20,2	114,0	18,6	113,0	-	62
66	21,7	106,0	19,6	106,0	19,4	106,0	17,6	105,0	16,1	104,0	14,5	103,0	-	66
70	18,6	93,0	16,4	97,0	16,2	98,6	14,3	97,3	12,7	96,3	11,1	95,3	-	70
74	-	-	13,5	86,8	13,3	90,8	11,3	90,1	9,7	89,3	8,0	88,1	-	74
75	-	-	12,9	84,0	12,6	88,7	10,6	88,5	9,0	87,7	7,3	86,5	-	75
78	-	-	-	-	10,7	82,5	8,6	83,5	7,0	83,0	5,2	81,5	-	78
80	-	-	-	-	9,6	77,5	7,5	79,6	5,8	80,0	-	78,3	-	80
81	-	-	-	-	-	-	6,9	77,7	5,2	78,5	-	76,7	-	81
82	-	-	-	-	-	-	6,4	75,8	-	76,6	-	75,1	-	82
84	-	-	-	-	-	-	5,3	72,0	-	73,0	-	72,0	-	84
85	-	-	-	-	-	-	-	70,0	-	71,3	-	70,0	-	85
86	-	-	-	-	-	-	-	-	-	69,6	-	68,1	-	86
90	-	-	-	-	-	-	-	-	-	63,0	-	60,5	-	90
94	-	-	-	-	-	-	-	-	-	-	-	54,3	-	94
96	-	-	-	-	-	-	-	-	-	-	-	52,0	-	96























0 t
65 t
125 t
165 t
205 t
245 t
285 t
325 t

225 t		11-19 m						12 m x 12 m						9.8 m/s		360°		ISO	
		54 m		60 m		66 m		72 m		78 m		84 m		90 m					
		LSL_2				LSL_1		LSL_2		LSL_1		LSL_2		LSL_1		LSL_2			
		0t-325t		0t-325t		0t-325t		0t-325t		0t-325t		0t-325t		0t-325t		0t-325t			
m	t	t	t	t	t	t	t	t	t	t	t	t	t	t	t	t	t	t	m
8	347,0	347,0	-	-	-	-	-	-	-	-	-	-	-	-	-	-	-	-	8
9	347,0	347,0	347,0	347,0	347,0	347,0	347,0	-	-	-	-	-	-	-	-	-	-	-	9
10	347,0	347,0	347,0	347,0	347,0	347,0	342,0	347,0	347,0	320,0	340,0	346,0	-	-	-	-	-	-	10
11	347,0	347,0	347,0	347,0	346,5	347,0	340,0	347,0	347,0	320,0	340,0	346,0	267,0	283,0	314,0	247,0	259,0	287,0	11
12	347,0	347,0	347,0	347,0	346,0	347,0	340,0	347,0	347,0	320,0	340,0	346,0	267,0	283,0	314,0	247,0	257,0	285,0	12
14	285,0	347,0	284,0	347,0	282,0	347,0	285,0	347,0	347,0	283,0	340,0	346,0	267,0	283,0	314,0	247,0	255,0	284,0	14
16	240,0	347,0	238,0	347,0	236,0	347,0	239,0	347,0	347,0	237,0	340,0	346,0	241,0	281,0	314,0	236,0	254,0	283,0	16
18	206,0	347,0	204,0	347,0	202,0	347,0	205,0	347,0	347,0	203,0	333,0	338,0	206,0	276,0	307,0	206,0	252,0	282,0	18
20	180,0	347,0	178,0	347,0	176,0	347,0	178,0	347,0	347,0	176,0	331,0	337,0	179,0	269,0	298,0	178,0	245,0	272,0	20
22	159,0	347,0	157,0	347,0	155,0	347,0	157,0	347,0	347,0	155,0	331,0	336,0	157,0	264,0	294,0	157,0	239,0	264,0	22
24	142,0	347,0	140,0	347,0	138,0	347,0	140,0	339,0	347,0	138,0	322,0	327,0	140,0	259,0	289,0	139,0	233,0	257,0	24
26	128,0	333,0	126,0	331,0	123,0	329,0	126,0	328,0	329,0	123,0	309,0	313,0	125,0	250,0	278,0	124,0	226,0	250,0	26
28	116,0	309,0	114,0	307,0	111,0	304,0	113,0	307,0	305,0	111,0	296,0	300,0	113,0	240,0	267,0	112,0	217,0	239,0	28
30	107,0	287,0	103,0	285,0	101,0	283,0	103,0	285,0	283,0	101,0	283,0	281,0	103,0	230,0	255,0	102,0	209,0	228,0	30
34	91,3	253,0	88,6	251,6	86,6	249,0	87,6	251,0	249,6	85,3	249,0	247,6	87,0	210,6	232,3	85,6	191,6	208,6	34
38	78,0	223,0	76,0	222,0	74,0	219,6	74,8	221,3	220,3	72,5	219,6	218,6	73,5	192,0	211,0	72,0	174,3	190,0	38
42	67,0	197,0	65,0	196,0	63,0	195,0	64,5	196,0	195,0	62,5	195,0	194,0	62,5	174,0	191,0	61,0	157,0	172,0	42
46	59,0	167,6	57,0	177,3	54,6	175,6	56,5	177,3	176,3	54,1	175,6	175,3	54,8	159,3	173,6	53,6	143,6	156,6	46
49	53,5	151,0	51,5	162,1	49,0	162,3	50,9	164,3	163,3	48,5	162,3	162,3	49,5	148,8	161,0	48,4	134,1	145,6	49
50	-	-	50,1	156,3	47,5	158,6	49,4	160,6	159,6	47,0	158,6	158,6	48,0	145,6	157,0	46,8	131,3	142,3	50
54	-	-	44,3	136,0	41,7	144,0	43,3	146,0	145,0	41,0	144,0	144,0	42,0	133,0	141,0	40,4	120,0	129,0	54
58	-	-	-	-	36,9	124,8	38,5	134,0	133,6	36,2	132,6	132,0	37,0	121,0	127,0	35,4	109,6	117,0	58
59	-	-	-	-	35,7	120,0	37,3	131,0	130,8	35,0	129,8	129,0	35,8	118,0	123,5	34,1	107,3	114,0	59
62	-	-	-	-	-	-	34,1	120,5	120,0	31,8	120,6	119,6	32,6	109,8	114,0	30,9	100,3	105,6	62
64	-	-	-	-	-	-	32,2	113,0	112,0	29,9	114,3	113,3	30,6	104,6	108,0	28,9	95,6	100,3	64
66	-	-	-	-	-	-	-	-	-	28,0	108,0	107,0	28,6	99,5	103,0	26,9	91,0	95,0	66
69	-	-	-	-	-	-	-	-	-	25,6	99,0	98,5	26,2	92,5	95,7	24,4	85,0	88,0	69
70	-	-	-	-	-	-	-	-	-	-	-	-	25,4	90,3	93,3	23,6	83,0	86,1	70
74	-	-	-	-	-	-	-	-	-	-	-	-	22,4	83,3	83,5	20,6	75,3	78,3	74
75	-	-	-	-	-	-	-	-	-	-	-	-	21,8	81,5	81,0	20,0	74,0	76,2	75
78	-	-	-	-	-	-	-	-	-	-	-	-	-	-	-	18,0	70,0	70,0	78
80	-	-	-	-	-	-	-	-	-	-	-	-	-	-	-	16,8	66,5	66,5	80

	0t	65t	125t	165t	205t	245t	285t	325t
--	----	-----	------	------	------	------	------	------

225 t																					
11-19 m						12 m x 12 m						9.8 m/s			360°			ISO			
96 m				99 m				102 m				105 m									
LSL_1		LSL_2		LSL_7		LSL_1		LSL_2		LSL_7		LSL_9		LSL_11		LSL_7		LSL_9		LSL_11	
0 t		0t-325t				0 t		0t-325t				0 t		0t-325t							
m	t	t	t	t	t	t	t	t	t	t	t	t	t	t	t	t	t	t	t	t	m
12	212,0	220,0	249,0	274,0	242,0	260,0	194,0	201,0	223,0	246,0	275,0	281,0	-	-	-	-	-	-	-	-	12
13	212,0	219,0	248,5	274,0	241,0	260,0	194,0	201,0	222,5	246,0	275,0	280,5	219,0	234,0	263,0	270,0	-	-	-	-	13
14	212,0	218,0	248,0	274,0	240,0	260,0	194,0	201,0	222,0	246,0	275,0	280,0	219,0	234,0	263,0	269,0	-	-	-	-	14
16	211,0	216,0	248,0	274,0	216,0	260,0	194,0	201,0	222,0	246,0	275,0	280,0	209,0	234,0	263,0	268,0	-	-	-	-	16
18	202,0	214,0	248,0	274,0	190,0	260,0	192,0	201,0	222,0	246,0	273,0	277,0	183,0	234,0	261,0	266,0	-	-	-	-	18
20	177,0	210,0	248,0	272,0	168,0	260,0	175,0	200,0	222,0	246,0	272,0	274,0	163,0	234,0	259,0	263,0	-	-	-	-	20
22	156,0	205,0	248,0	268,0	148,0	255,0	155,0	200,0	222,0	241,0	271,0	272,0	146,0	230,0	258,0	262,0	-	-	-	-	22
24	138,0	200,0	248,0	267,0	130,0	252,0	138,0	199,0	222,0	237,0	266,0	268,0	128,0	224,0	254,0	260,0	-	-	-	-	24
26	123,0	195,0	248,0	267,0	115,0	252,0	123,0	198,0	222,0	236,0	263,0	265,0	113,0	222,0	249,0	256,0	-	-	-	-	26
28	111,0	189,0	244,0	266,0	103,0	252,0	110,0	197,0	222,0	235,0	259,0	260,0	101,0	221,0	246,0	253,0	-	-	-	-	28
30	100,0	182,0	235,0	256,0	92,5	244,0	100,0	197,0	220,0	231,0	250,0	253,0	90,5	219,0	238,0	245,0	-	-	-	-	30
34	84,3	168,0	220,0	234,0	76,5	228,6	83,6	188,3	212,0	215,3	232,0	237,6	74,1	204,0	220,6	229,0	-	-	-	-	34
38	71,0	154,0	208,3	211,0	62,8	209,0	69,8	177,0	201,0	200,0	214,6	219,6	60,5	190,3	203,6	212,6	-	-	-	-	38
42	60,0	140,0	191,0	187,0	51,5	185,0	58,5	170,0	189,0	184,0	198,0	199,0	49,6	177,0	187,0	196,0	-	-	-	-	42
46	51,8	128,0	172,3	168,3	43,5	167,0	50,4	162,0	171,0	166,0	179,3	179,0	41,3	163,0	172,3	177,3	-	-	-	-	46
50	44,9	117,0	156,0	152,0	36,7	151,0	43,5	153,6	154,6	150,0	162,6	161,6	34,0	149,0	158,6	160,3	-	-	-	-	50
54	39,3	107,0	142,0	138,0	31,1	137,0	37,9	143,0	140,0	136,0	148,0	147,0	27,8	135,0	146,0	145,0	-	-	-	-	54
58	34,2	98,0	130,0	126,0	26,0	125,6	32,8	131,0	128,6	124,6	135,3	134,3	23,4	123,6	134,0	133,0	-	-	-	-	58
62	29,7	89,1	119,3	115,3	21,4	115,0	28,2	120,0	118,0	114,0	124,0	123,0	19,1	113,3	123,0	122,0	-	-	-	-	62
66	25,7	81,0	110,0	106,0	17,4	105,0	24,2	110,0	108,0	104,0	114,0	113,0	15,1	104,0	113,0	112,0	-	-	-	-	66
70	22,3	73,6	102,3	98,3	14,1	97,3	20,8	102,6	100,6	96,6	105,3	104,3	11,7	96,0	104,3	103,6	-	-	-	-	70
74	19,3	66,6	95,1	91,3	11,1	90,3	17,7	95,6	93,6	89,6	97,6	96,8	8,7	87,6	95,6	96,1	-	-	-	-	74
78	16,6	60,0	88,5	85,0	8,4	84,0	15,0	89,0	87,0	83,0	91,0	90,5	6,0	79,0	87,0	89,5	-	-	-	-	78
81	14,9	55,2	83,2	79,0	6,6	79,0	13,2	84,7	82,7	77,9	86,0	86,0	4,2	73,0	81,0	84,2	-	-	-	-	81
82	14,4	53,6	81,5	77,0	6,0	77,3	12,6	83,3	81,3	76,2	84,3	84,5	-	70,8	79,0	82,5	-	-	-	-	82
85	12,8	49,3	76,0	71,0	4,4	72,0	11,0	78,9	76,8	70,4	78,8	80,0	-	65,6	73,3	75,9	-	-	-	-	85
86	-	-	-	-	-	70,0	10,5	77,3	75,1	68,3	76,7	78,3	-	63,8	71,6	73,8	-	-	-	-	86
88	-	-	-	-	-	66,0	9,5	74,1	71,8	64,1	72,5	74,9	-	60,1	68,3	69,6	-	-	-	-	88
90	-	-	-	-	-	-	8,6	71,0	68,5	61,5	69,0	71,5	-	56,5	65,0	67,0	-	-	-	-	90
93	-	-	-	-	-	-	-	-	-	-	-	-	-	52,0	59,5	62,0	-	-	-	-	93



 225 t  11-19 m  12 m x 12 m  9.8 m/s 360° ISO															
 108 m  111 m															
 LSL_1  LSL_2  LSL_5  LSL_7  LSL_9  LSL_11  LSL_13  LSL_5  LSL_7  LSL_9  LSL_11 LSL_13															
 0 t  0t-325t  0 t  0t-325t															
m	t	t	t	t	t	t	t	t	t	t	t	t	t	t	m
13	176,0	182,0	200,0	-	224,0	247,0	247,0	-	-	-	213,0	238,0	247,0	-	13
14	176,0	182,0	200,0	-	224,0	247,0	247,0	-	-	-	213,0	238,0	247,0	-	14
16	176,0	182,0	200,0	-	224,0	247,0	247,0	-	-	-	212,0	238,0	246,0	-	16
18	176,0	182,0	200,0	-	223,0	247,0	247,0	-	-	-	211,0	238,0	245,0	-	18
20	169,0	182,0	200,0	-	223,0	247,0	247,0	-	-	-	209,0	238,0	243,0	-	20
22	152,0	182,0	200,0	-	220,0	247,0	247,0	-	-	-	207,0	238,0	242,0	-	22
24	137,0	181,0	199,0	-	215,0	247,0	247,0	-	-	-	203,0	238,0	241,0	-	24
26	122,0	180,0	199,0	-	211,0	247,0	247,0	-	-	-	200,0	236,0	235,0	-	26
28	109,0	180,0	199,0	-	209,0	245,0	244,0	-	-	-	197,0	236,0	231,0	-	28
30	99,0	180,0	199,0	-	207,0	242,0	237,0	-	-	-	195,0	234,0	226,0	-	30
34	82,3	175,3	193,6	-	193,6	227,3	219,6	-	-	-	183,0	218,6	208,6	-	34
38	68,3	169,0	186,3	-	180,3	213,3	202,6	-	-	-	170,6	206,6	192,0	-	38
42	57,0	165,0	181,0	-	167,0	198,0	186,0	-	-	-	158,0	196,0	176,0	-	42
46	48,8	155,3	167,0	-	155,0	178,0	171,3	-	-	-	146,0	176,6	161,3	-	46
50	41,6	149,0	152,6	-	143,0	160,3	157,3	-	-	-	134,3	159,3	147,6	-	50
54	35,2	141,0	138,0	-	131,0	145,0	144,0	-	-	-	123,0	144,0	135,0	-	54
58	30,8	129,6	126,6	-	120,3	133,0	132,0	-	-	-	113,0	132,0	123,6	-	58
62	26,5	119,0	116,3	-	110,0	122,0	121,0	-	-	-	103,1	121,0	113,3	-	62
66	22,4	109,0	107,0	-	100,0	112,0	111,0	-	-	-	93,5	111,0	104,0	-	66
70	19,0	101,3	99,3	-	91,6	103,6	102,6	-	-	-	85,1	102,6	95,6	-	70
74	15,8	94,1	92,1	-	83,3	96,0	94,3	-	-	-	77,0	95,0	87,3	-	74
78	13,0	87,5	85,5	-	75,0	89,0	86,0	-	-	-	69,5	88,0	79,5	-	78
82	10,6	81,8	79,8	-	67,8	83,0	77,5	-	-	-	62,1	82,2	72,1	-	82
86	8,4	76,6	74,6	-	60,3	77,8	70,1	-	-	-	55,6	76,8	64,8	-	86
90	6,4	72,0	70,0	-	54,0	72,5	63,5	-	-	-	49,0	71,5	58,5	-	90
94	4,6	65,6	63,2	-	47,9	67,3	56,3	-	-	-	43,1	66,5	52,1	-	94
95	4,2	64,0	61,5	-	46,4	66,0	55,0	-	-	-	42,0	65,2	50,5	-	95
98	-	-	-	-	-	-	-	-	-	-	37,5	61,5	46,2	-	98

 0t
  65t
  125t
  165t
  205t
  245t
  285t
  325t

225 t															
11-19 m															
12 m x 12 m															
9.8 m/s															
360°															
ISO															
114 m															
117 m															
LSL_1 LSL_2 LSL_5 LSL_7 LSL_9 LSL_11 LSL_13 LSL_5 LSL_7 LSL_9 LSL_11 LSL_13															
0 t 0t-325t 0 t 0t-325t															
m	t	t	t	t	t	t	t	t	t	t	t	t	t	t	m
13	159,0	165,0	180,0	190,0	200,0	226,0	238,0	-	-	-	-	-	-	-	13
14	159,0	165,0	180,0	190,0	200,0	226,0	237,0	-	172,0	180,0	189,0	216,0	227,0	-	14
16	159,0	165,0	180,0	190,0	200,0	226,0	236,0	-	172,0	180,0	189,0	216,0	225,0	-	16
18	159,0	165,0	180,0	190,0	200,0	226,0	235,0	-	168,0	180,0	189,0	216,0	225,0	-	18
20	159,0	165,0	180,0	190,0	200,0	226,0	231,0	-	155,0	180,0	189,0	215,0	221,0	-	20
22	147,0	165,0	180,0	190,0	200,0	226,0	230,0	-	139,0	180,0	189,0	214,0	218,0	-	22
24	133,0	164,0	180,0	189,0	200,0	226,0	229,0	-	126,0	180,0	188,0	214,0	217,0	-	24
26	120,0	163,0	179,0	189,0	199,0	225,0	224,0	-	114,0	179,0	188,0	213,0	213,0	-	26
28	107,0	163,0	179,0	188,0	198,0	223,0	219,0	-	102,0	178,0	187,0	212,0	208,0	-	28
30	97,0	163,0	179,0	187,0	197,0	220,0	214,0	-	92,0	177,0	186,0	210,0	202,0	-	30
34	80,3	159,6	175,0	179,3	191,3	206,0	198,0	-	75,3	173,6	182,0	202,0	186,6	-	34
38	66,3	155,6	170,3	171,6	183,0	191,6	182,3	-	61,3	166,0	175,3	191,3	171,6	-	38
42	55,0	151,0	165,0	167,0	177,0	181,0	167,0	-	50,0	160,0	168,0	182,0	157,0	-	42
46	46,8	145,0	160,3	159,6	161,6	167,3	153,0	-	41,8	156,0	158,0	170,3	143,6	-	46
50	39,5	139,0	151,0	150,0	147,0	155,6	140,0	-	34,5	147,6	146,0	157,3	131,3	-	50
54	33,1	135,0	137,0	136,0	133,0	143,0	128,0	-	28,1	135,0	132,0	142,0	120,0	-	54
58	28,7	126,3	125,6	124,6	121,6	131,0	117,3	-	23,1	123,0	120,6	130,0	109,3	-	58
62	24,4	117,3	115,3	114,3	111,3	120,0	107,1	-	18,8	112,6	110,3	119,0	99,3	-	62
66	20,2	108,0	106,0	105,0	102,0	110,0	97,5	-	15,3	104,0	101,0	109,0	90,0	-	66
70	16,8	100,0	98,3	97,3	94,3	100,6	89,5	-	11,8	96,0	93,3	101,0	82,3	-	70
74	13,7	92,6	91,1	90,1	87,3	92,5	82,0	-	8,7	88,8	85,8	93,5	75,1	-	74
78	10,9	86,0	84,5	83,5	81,0	85,5	75,0	-	5,9	82,5	79,5	86,5	68,5	-	78
80	9,7	83,1	81,6	80,5	78,1	82,5	71,5	-	4,6	79,5	76,6	83,5	65,1	-	80
82	8,5	80,3	78,8	77,5	75,3	79,5	68,0	-	-	76,7	73,8	80,5	61,8	-	82
86	6,2	75,1	73,5	72,5	69,6	74,0	61,5	-	-	71,5	68,6	75,0	55,4	-	86
90	4,2	70,5	68,5	67,5	64,0	69,0	54,5	-	-	66,5	64,0	70,0	49,5	-	90
94	-	65,8	63,8	62,5	58,6	64,3	47,5	-	-	62,1	58,3	65,6	43,4	-	94
98	-	60,5	58,5	56,8	53,2	60,0	41,2	-	-	57,0	53,0	61,0	35,4	-	98
101	-	56,0	54,0	52,0	49,1	57,0	36,7	-	-	52,5	49,2	57,2	28,8	-	101
102	-	-	-	-	-	-	-	-	-	51,0	48,0	56,0	27,2	-	102
103	-	-	-	-	-	-	-	-	-	49,8	46,5	55,0	25,0	-	103

 0t
 65t
 125t
 165t
 205t
 245t
 285t
 325t

225 t		11-19 m						12 m x 12 m				9.8 m/s		360°		ISO							
120 m										123 m													
LSL_1		LSL_2		LSL_5		LSL_7		LSL_9		LSL_11		LSL_13		LSL_5		LSL_7		LSL_9		LSL_11		LSL_13	
0 t		0t-325t										0 t		0t-325t									
m	t	t	t	t	t	t	t	t	t	t	t	t	t	t	t	t	t	t	t	t	t	t	m
14	137,0	141,0	156,0	164,0	182,0	205,0	213,0	220,0	220,0	150,0	156,0	171,0	196,0	203,0	210,0	210,0	14						
16	137,0	141,0	155,0	164,0	182,0	205,0	213,0	220,0	220,0	150,0	156,0	171,0	196,0	203,0	210,0	210,0	16						
18	137,0	140,0	155,0	164,0	182,0	205,0	213,0	220,0	220,0	150,0	156,0	171,0	196,0	203,0	210,0	210,0	18						
20	136,0	140,0	155,0	164,0	181,0	205,0	212,0	220,0	220,0	148,0	156,0	171,0	196,0	203,0	210,0	210,0	20						
22	136,0	140,0	155,0	164,0	181,0	204,0	211,0	219,0	220,0	135,0	156,0	171,0	195,0	202,0	209,0	210,0	22						
24	130,0	139,0	155,0	163,0	181,0	204,0	210,0	217,0	220,0	122,0	155,0	170,0	195,0	201,0	209,0	210,0	24						
26	118,0	138,0	154,0	162,0	180,0	203,0	210,0	217,0	220,0	111,0	155,0	169,0	194,0	201,0	208,0	210,0	26						
28	108,0	138,0	154,0	161,0	178,0	202,0	209,0	216,0	220,0	101,0	154,0	168,0	193,0	200,0	207,0	210,0	28						
30	97,5	137,0	154,0	161,0	177,0	201,0	207,0	214,0	220,0	91,0	154,0	168,0	192,0	199,0	205,0	210,0	30						
34	80,8	135,6	152,6	159,0	173,6	194,6	201,0	199,0	220,0	74,3	152,6	165,3	187,3	193,3	196,0	210,0	34						
38	66,6	133,6	150,3	153,3	168,6	186,6	192,0	185,0	220,0	60,4	149,3	160,3	178,3	186,0	197,0	210,0	38						
42	55,0	131,0	147,0	149,0	162,0	179,0	184,0	169,0	220,0	49,3	144,0	155,0	171,0	179,0	164,0	210,0	42						
46	46,7	127,6	143,6	143,6	155,3	169,6	170,6	155,0	220,0	40,9	139,6	149,6	161,6	168,3	148,0	210,0	46						
50	39,3	123,6	140,0	138,0	145,0	157,3	156,3	141,3	220,0	33,5	135,6	141,0	152,3	155,3	134,3	210,0	50						
54	32,9	119,0	136,0	134,0	131,0	142,0	141,0	128,0	220,0	27,1	133,0	129,0	141,0	140,0	121,0	210,0	54						
58	27,7	115,0	124,6	122,6	119,6	129,3	129,0	115,3	220,0	22,0	121,6	117,6	128,3	128,0	108,3	210,0	58						
62	23,4	110,3	114,3	112,6	109,3	118,3	118,0	103,5	220,0	17,7	111,3	107,6	117,3	117,0	98,0	210,0	62						
66	19,8	107,0	105,0	104,0	100,0	109,0	108,0	92,5	220,0	14,2	102,0	99,0	108,0	107,0	88,0	210,0	66						
70	16,4	99,6	97,3	96,0	92,3	100,6	100,0	83,1	220,0	10,8	94,6	91,0	99,6	99,0	78,0	210,0	70						
74	13,2	92,6	90,1	88,8	85,0	92,8	92,3	74,6	220,0	7,6	87,8	83,8	92,0	91,7	69,6	210,0	74						
78	10,3	86,0	83,5	82,5	78,5	86,0	85,5	67,0	220,0	4,8	81,5	77,5	85,0	84,5	62,0	210,0	78						
79	9,7	84,5	82,1	81,0	77,1	84,5	84,0	65,5	220,0	4,1	80,0	76,0	83,5	83,0	60,5	210,0	79						
82	7,9	80,3	77,9	76,6	73,1	80,0	79,8	61,0	220,0	-	75,8	71,8	79,0	78,5	56,0	210,0	82						
86	5,6	74,9	72,6	71,5	68,0	74,5	74,3	55,5	220,0	-	70,5	66,6	73,0	73,0	50,6	210,0	86						
89	4,0	71,0	69,1	67,7	64,2	70,7	70,3	51,7	220,0	-	66,7	63,1	68,5	69,2	47,0	210,0	89						
90	-	70,0	68,0	66,5	63,0	69,5	69,0	50,5	220,0	-	65,5	62,0	67,0	68,0	45,8	210,0	90						
94	-	65,6	63,6	62,5	58,3	65,1	64,6	47,3	220,0	-	61,5	57,6	61,6	63,6	42,2	210,0	94						
98	-	61,3	59,0	57,8	53,5	60,6	60,3	44,8	220,0	-	57,1	53,0	56,8	59,5	39,0	210,0	98						
102	-	57,0	54,0	52,5	48,3	56,0	56,0	43,0	220,0	-	52,5	48,2	52,5	55,5	36,9	210,0	102						
106	-	51,5	48,9	47,2	42,8	51,5	51,0	42,3	220,0	-	47,3	43,0	49,2	50,8	35,9	210,0	106						
108	-	-	-	-	-	-	-	-	220,0	-	44,8	40,4	47,8	48,5	35,4	210,0	108						

	0t	65t	125t	165t	205t	245t	285t	325t
---	----	-----	------	------	------	------	------	------

225 t		11-19 m						12 m x 12 m			9.8 m/s			360°		ISO							
126 m										129 m													
LSL_1		LSL_2		LSL_5		LSL_7		LSL_9		LSL_11		LSL_13		LSL_5		LSL_7		LSL_9		LSL_11		LSL_13	
0 t		0t-325t										0 t		0t-325t									
m	t	t	t	t	t	t	t	t	t	t	t	t	t	t	t	t	t	t	t	t	t	t	m
14	118,0	121,0	135,0	149,0	161,0	185,0	193,0	201,0	-	-	-	-	-	-	-	-	-	-	-	-	-	-	14
15	117,5	121,0	135,0	149,0	161,0	184,5	193,0	201,0	136,0	140,0	152,0	177,0	184,0	191,0	191,0	191,0	191,0	191,0	191,0	191,0	191,0	191,0	15
16	117,0	121,0	135,0	149,0	161,0	184,0	193,0	201,0	136,0	140,0	152,0	177,0	184,0	191,0	191,0	191,0	191,0	191,0	191,0	191,0	191,0	191,0	16
18	117,0	121,0	135,0	149,0	161,0	184,0	193,0	201,0	136,0	140,0	152,0	176,0	184,0	191,0	191,0	191,0	191,0	191,0	191,0	191,0	191,0	191,0	18
20	117,0	120,0	135,0	149,0	161,0	183,0	193,0	201,0	136,0	140,0	151,0	175,0	184,0	191,0	191,0	191,0	191,0	191,0	191,0	191,0	191,0	191,0	20
22	117,0	120,0	134,0	149,0	161,0	182,0	192,0	200,0	130,0	140,0	151,0	174,0	183,0	191,0	191,0	191,0	191,0	191,0	191,0	191,0	191,0	191,0	22
24	116,0	119,0	134,0	149,0	160,0	181,0	192,0	200,0	118,0	139,0	151,0	173,0	183,0	190,0	190,0	190,0	190,0	190,0	190,0	190,0	190,0	190,0	24
26	115,0	118,0	134,0	148,0	160,0	181,0	191,0	199,0	107,0	139,0	151,0	173,0	182,0	190,0	190,0	190,0	190,0	190,0	190,0	190,0	190,0	190,0	26
28	106,0	117,0	133,0	148,0	159,0	180,0	190,0	198,0	97,5	138,0	150,0	173,0	182,0	189,0	189,0	189,0	189,0	189,0	189,0	189,0	189,0	189,0	28
30	97,0	117,0	133,0	147,0	158,0	179,0	189,0	196,0	89,0	138,0	149,0	171,0	180,0	187,0	187,0	187,0	187,0	187,0	187,0	187,0	187,0	187,0	30
34	80,3	115,6	132,3	145,6	156,6	175,0	185,6	188,3	73,3	136,6	147,6	168,3	177,0	184,0	184,0	184,0	184,0	184,0	184,0	184,0	184,0	184,0	34
38	66,1	114,0	131,0	143,0	152,3	169,6	176,6	179,0	59,7	134,6	144,3	163,6	170,0	175,0	175,0	175,0	175,0	175,0	175,0	175,0	175,0	175,0	38
42	54,5	112,0	129,0	139,0	147,0	163,0	168,0	168,0	48,1	132,0	139,0	157,0	162,0	166,0	166,0	166,0	166,0	166,0	166,0	166,0	166,0	166,0	42
46	46,1	110,0	125,6	135,0	142,3	155,6	158,6	156,0	39,6	128,6	135,0	150,0	153,6	154,6	154,6	154,6	154,6	154,6	154,6	154,6	154,6	154,6	46
50	38,7	107,6	123,0	131,3	136,3	148,0	149,6	146,0	32,1	125,6	130,0	143,0	145,3	145,6	145,6	145,6	145,6	145,6	145,6	145,6	145,6	145,6	50
54	32,3	105,0	121,0	128,0	129,0	140,0	139,0	136,0	25,6	123,0	126,0	137,0	138,0	137,0	137,0	137,0	137,0	137,0	137,0	137,0	137,0	137,0	54
58	27,1	101,0	116,3	120,0	117,6	128,0	127,0	124,6	20,5	117,6	116,0	126,3	126,0	125,0	125,0	125,0	125,0	125,0	125,0	125,0	125,0	125,0	58
62	22,8	97,3	111,6	111,3	107,5	117,0	116,3	113,0	15,9	110,3	106,5	116,0	115,0	114,0	114,0	114,0	114,0	114,0	114,0	114,0	114,0	114,0	62
66	19,2	95,0	105,0	102,0	98,5	107,0	107,0	101,0	11,8	101,0	97,5	106,0	105,0	104,0	104,0	104,0	104,0	104,0	104,0	104,0	104,0	104,0	66
70	15,7	92,5	97,3	94,3	90,8	99,0	98,6	90,5	8,8	93,3	89,5	97,6	97,0	93,7	93,7	93,7	93,7	93,7	93,7	93,7	93,7	93,7	70
74	12,5	89,5	90,1	87,1	83,6	91,1	90,6	81,5	5,9	86,0	82,3	89,3	88,5	83,8	83,8	83,8	83,8	83,8	83,8	83,8	83,8	83,8	74
76	11,1	87,5	86,8	83,8	80,3	87,3	86,8	77,0	4,4	82,5	79,1	84,6	84,0	79,1	79,1	79,1	79,1	79,1	79,1	79,1	79,1	79,1	76
78	9,7	85,5	83,5	80,5	77,0	83,5	83,0	72,5	-	79,5	76,0	80,0	79,5	74,5	74,5	74,5	74,5	74,5	74,5	74,5	74,5	74,5	78
82	7,2	79,8	77,9	75,1	71,3	75,8	75,3	65,1	-	73,8	70,3	71,3	71,1	66,5	66,5	66,5	66,5	66,5	66,5	66,5	66,5	66,5	82
86	4,9	74,3	73,0	70,0	66,1	69,0	68,6	58,5	-	68,6	65,0	64,0	64,0	59,1	59,1	59,1	59,1	59,1	59,1	59,1	59,1	59,1	86
87	4,4	73,0	71,7	68,7	65,0	67,5	67,2	57,0	-	67,5	63,7	62,5	62,5	57,5	57,5	57,5	57,5	57,5	57,5	57,5	57,5	57,5	87
90	-	69,5	68,0	65,0	61,5	63,0	63,0	52,5	-	64,0	60,0	58,0	58,0	52,5	52,5	52,5	52,5	52,5	52,5	52,5	52,5	52,5	90
94	-	65,1	63,6	61,0	57,1	57,6	58,0	48,2	-	59,6	56,0	53,0	53,0	47,7	47,7	47,7	47,7	47,7	47,7	47,7	47,7	47,7	94
98	-	61,1	59,6	56,8	52,7	52,9	53,2	44,5	-	55,6	51,8	48,4	48,6	43,7	43,7	43,7	43,7	43,7	43,7	43,7	43,7	43,7	98
102	-	57,5	56,0	52,5	47,9	48,9	49,3	41,7	-	52,0	47,5	44,2	44,5	40,3	40,3	40,3	40,3	40,3	40,3	40,3	40,3	40,3	102
106	-	53,1	51,2	47,9	43,4	45,5	46,0	40,3	-	47,5	43,0	40,6	41,0	38,3	38,3	38,3	38,3	38,3	38,3	38,3	38,3	38,3	106
110	-	48,4	46,3	42,9	38,7	42,4	43,0	39,4	-	42,9	38,5	37,3	37,9	37,1	37,1	37,1	37,1	37,1	37,1	37,1	37,1	37,1	110
111	-	47,2	45,1	41,7	37,5	41,7	42,4	39,4	-	41,7	37,3	36,6	37,2	37,0	37,0	37,0	37,0	37,0	37,0	37,0	37,0	37,0	111
114	-	-	-	-	-	-	-	-	-	38,2	33,9	34,5	35,2	36,7	36,7	36,7	36,7	36,7	36,7	36,7	36,7	36,7	114

0t
65t
125t
165t
205t
245t
285t
325t

225 t		11-19 m							12 m x 12 m			9.8 m/s		360°		ISO												
132 m											135 m																	
LSL_1		LSL_2		LSL_5		LSL_7		LSL_9		LSL_11		LSL_13		LSL_15		LSL_5		LSL_7		LSL_9		LSL_11		LSL_13		LSL_15		
0 t		0t-325t											0 t		0t-325t													
m	t	t	t	t	t	t	t	t	t	t	t	t	t	t	t	t	t	t	t	t	t	t	t	t	t	t	t	m
15	100,0	103,0	117,0	130,0	141,0	161,0	168,0	184,0	196,0	120,0	124,0	134,0	153,0	160,0	175,0	186,0	15											
16	100,0	103,0	117,0	130,0	141,0	161,0	168,0	184,0	196,0	120,0	124,0	134,0	153,0	159,0	175,0	186,0	16											
18	100,0	102,0	117,0	130,0	141,0	161,0	168,0	183,0	196,0	120,0	123,0	133,0	153,0	159,0	175,0	186,0	18											
20	100,0	102,0	116,0	130,0	141,0	161,0	168,0	183,0	196,0	120,0	123,0	133,0	153,0	159,0	175,0	186,0	20											
22	99,5	101,0	116,0	130,0	140,0	161,0	167,0	182,0	196,0	120,0	123,0	133,0	152,0	159,0	175,0	186,0	22											
24	99,0	101,0	116,0	129,0	140,0	160,0	167,0	181,0	196,0	115,0	123,0	133,0	152,0	158,0	174,0	186,0	24											
26	98,0	100,0	115,0	129,0	140,0	159,0	166,0	180,0	196,0	104,0	122,0	132,0	151,0	158,0	173,0	186,0	26											
28	97,5	99,5	115,0	128,0	139,0	158,0	165,0	180,0	196,0	95,0	122,0	132,0	151,0	157,0	172,0	186,0	28											
30	95,0	99,0	114,0	127,0	139,0	157,0	164,0	179,0	194,5	86,5	121,0	131,0	150,0	156,0	172,0	185,0	30											
34	78,6	97,5	113,3	125,6	137,6	155,0	162,0	177,0	192,0	71,5	120,3	129,6	147,3	154,0	169,6	182,5	34											
38	64,8	96,0	112,3	124,0	135,3	150,0	155,0	170,3	185,5	58,3	119,0	128,0	143,6	149,3	164,6	177,0	38											
42	53,5	94,0	111,0	122,0	132,0	144,0	149,0	161,0	174,3	47,1	117,0	126,0	139,0	144,0	156,0	167,6	42											
46	45,3	92,0	109,0	118,6	128,6	139,0	143,0	150,6	161,0	38,5	114,3	122,6	134,0	138,3	145,0	157,0	46											
50	38,0	90,0	107,0	115,3	125,3	134,6	137,3	139,6	145,6	31,0	111,6	119,6	130,3	133,3	135,0	143,0	50											
54	31,6	88,0	105,0	113,0	122,0	130,0	133,0	129,0	131,3	24,6	109,0	117,0	127,0	129,0	125,0	129,6	54											
58	26,5	85,3	102,0	108,3	116,0	124,3	125,0	119,0	118,0	19,4	106,3	113,6	122,6	123,0	113,6	117,0	58											
62	21,9	82,8	99,1	105,0	108,3	117,0	116,3	108,6	108,0	14,8	103,1	107,3	116,0	115,0	103,4	106,3	62											
66	17,9	80,5	95,5	101,0	99,0	107,0	107,0	98,0	98,6	10,7	99,5	98,0	106,0	105,0	94,0	97,0	66											
70	14,9	77,5	92,1	93,3	91,3	99,0	98,6	88,0	90,0	7,8	92,1	90,0	97,6	97,0	84,0	89,0	70											
74	12,0	74,6	87,8	86,0	83,9	91,5	91,0	79,0	83,0	4,8	84,8	82,8	90,1	89,6	74,6	81,6	74											
75	11,3	74,2	86,5	84,2	82,3	89,7	89,2	76,7	81,2	4,1	83,0	81,2	88,5	88,0	72,5	79,8	75											
78	9,2	73,0	82,5	79,5	77,5	84,5	84,0	70,0	76,3	-	78,5	76,5	83,5	83,0	66,5	74,8	78											
82	6,7	71,0	76,6	73,8	71,8	78,5	78,0	62,6	70,0	-	72,8	70,8	77,5	77,0	58,8	68,5	82											
86	4,4	68,0	71,6	68,6	66,6	73,0	72,5	55,8	64,7	-	67,6	65,5	71,8	71,3	51,9	63,5	86											
90	-	64,5	67,0	64,0	62,0	68,0	67,5	49,6	59,6	-	63,0	60,5	66,5	66,0	45,8	58,1	90											
94	-	61,1	62,6	59,6	57,6	63,3	63,1	44,3	55,0	-	58,6	56,5	62,1	61,6	40,6	52,5	94											
98	-	57,8	58,6	55,6	53,5	59,0	58,6	39,9	51,2	-	54,7	52,6	58,0	57,5	36,0	47,7	98											
102	-	54,5	55,0	52,0	50,0	55,5	55,0	36,1	47,5	-	51,0	49,0	54,0	53,5	32,0	43,2	102											
106	-	51,3	51,2	48,0	45,8	51,1	50,8	33,3	44,0	-	47,4	45,1	50,0	49,7	29,0	39,1	106											
110	-	48,0	47,1	43,8	41,4	46,8	46,6	31,2	40,8	-	43,4	41,0	46,0	45,8	26,6	35,7	110											
114	-	44,7	42,7	39,4	37,0	42,6	42,5	29,8	37,7	-	39,1	36,7	41,8	41,6	24,8	32,6	114											
116	-	42,7	40,4	37,1	34,7	40,7	40,6	29,4	36,1	-	36,9	34,5	39,9	39,7	24,2	31,2	116											
118	-	-	-	-	-	-	-	-	-	-	34,7	32,4	38,0	37,9	23,8	29,8	118											
119	-	-	-	-	-	-	-	-	-	-	33,7	31,4	37,1	37,0	23,7	29,3	119											

	0 t	65 t	125 t	165 t	205 t	245 t	285 t	325 t
---	-----	------	-------	-------	-------	-------	-------	-------

225 t																		11-19 m		12 m x 12 m		9.8 m/s		360°		ISO	
138 m										141 m																	
LSL_1		LSL_2		LSL_5		LSL_7		LSL_9		LSL_11		LSL_13		LSL_15		LSL_5		LSL_7		LSL_9		LSL_11		LSL_13		LSL_15	
0 t		0t-325t										0 t		0t-325t													
m	t	t	t	t	t	t	t	t	t	t	t	t	t	t	t	t	t	t	t	t	t	t	t	t	t	t	m
15	86,0	89,0	100,0	120,0	126,0	144,0	151,0	167,0	177,0	-	-	-	-	-	-	-	-	-	-	-	-	-	-	-	-	-	15
16	86,0	89,0	100,0	120,0	126,0	144,0	151,0	167,0	177,0	110,0	114,0	119,0	135,0	144,0	158,0	168,0	168,0	168,0	168,0	168,0	168,0	168,0	168,0	168,0	168,0	168,0	16
18	85,5	88,0	100,0	120,0	126,0	144,0	151,0	167,0	177,0	110,0	114,0	119,0	134,0	143,0	158,0	168,0	168,0	168,0	168,0	168,0	168,0	168,0	168,0	168,0	168,0	168,0	18
20	85,5	87,5	100,0	120,0	125,0	143,0	151,0	167,0	177,0	110,0	113,0	119,0	134,0	143,0	158,0	168,0	168,0	168,0	168,0	168,0	168,0	168,0	168,0	168,0	168,0	168,0	20
22	85,5	87,0	99,5	119,0	125,0	143,0	151,0	167,0	177,0	110,0	113,0	118,0	134,0	143,0	158,0	168,0	168,0	168,0	168,0	168,0	168,0	168,0	168,0	168,0	168,0	168,0	22
24	84,5	86,5	99,0	119,0	125,0	142,0	150,0	166,0	177,0	108,0	113,0	118,0	133,0	143,0	158,0	167,0	167,0	167,0	167,0	167,0	167,0	167,0	167,0	167,0	167,0	167,0	24
26	84,0	86,0	98,5	119,0	125,0	141,0	150,0	166,0	177,0	99,5	112,0	118,0	133,0	142,0	158,0	167,0	167,0	167,0	167,0	167,0	167,0	167,0	167,0	167,0	167,0	167,0	26
28	83,0	85,0	98,0	118,0	124,0	140,0	149,0	165,0	177,0	90,5	112,0	117,0	133,0	141,0	157,0	167,0	167,0	167,0	167,0	167,0	167,0	167,0	167,0	167,0	167,0	167,0	28
30	82,5	84,5	97,0	118,0	124,0	139,0	148,0	165,0	176,0	82,5	111,0	117,0	132,0	141,0	157,0	166,5	166,5	166,5	166,5	166,5	166,5	166,5	166,5	166,5	166,5	166,5	30
34	74,5	82,3	96,3	116,6	122,6	136,3	146,0	160,6	173,5	69,5	110,3	115,6	130,6	138,6	153,3	164,5	164,5	164,5	164,5	164,5	164,5	164,5	164,5	164,5	164,5	164,5	34
38	65,1	81,3	95,3	115,0	121,0	132,6	142,6	151,6	169,0	57,2	109,3	114,3	128,6	135,6	146,3	160,5	160,5	160,5	160,5	160,5	160,5	160,5	160,5	160,5	160,5	160,5	38
42	53,5	80,0	94,0	113,0	119,0	128,0	138,0	143,0	161,0	45,6	108,0	113,0	126,0	131,0	138,0	154,6	154,6	154,6	154,6	154,6	154,6	154,6	154,6	154,6	154,6	154,6	42
46	45,3	78,3	92,3	110,3	116,3	124,0	132,3	130,3	153,0	37,0	105,3	110,3	122,6	126,3	128,0	148,0	148,0	148,0	148,0	148,0	148,0	148,0	148,0	148,0	148,0	148,0	46
50	38,0	76,5	90,8	108,0	113,6	118,0	128,3	119,6	141,0	29,4	103,0	107,6	119,6	122,3	116,6	137,3	137,3	137,3	137,3	137,3	137,3	137,3	137,3	137,3	137,3	137,3	50
54	31,6	74,5	89,5	106,0	111,0	114,0	125,0	109,0	128,6	22,8	101,0	105,0	117,0	119,0	106,0	126,5	126,5	126,5	126,5	126,5	126,5	126,5	126,5	126,5	126,5	126,5	54
58	26,4	73,1	88,1	103,3	108,3	109,0	120,6	99,0	116,0	17,6	99,0	103,0	113,6	113,6	96,0	115,0	115,0	115,0	115,0	115,0	115,0	115,0	115,0	115,0	115,0	115,0	58
62	21,8	71,6	85,3	99,5	103,8	103,8	114,0	88,6	106,0	12,9	96,5	100,1	109,3	109,0	86,0	104,6	104,6	104,6	104,6	104,6	104,6	104,6	104,6	104,6	104,6	104,6	62
66	17,7	70,0	83,0	94,5	97,5	99,5	104,0	79,5	96,6	8,7	93,5	96,5	104,0	103,0	76,5	95,1	95,1	95,1	95,1	95,1	95,1	95,1	95,1	95,1	95,1	95,1	66
70	14,7	67,8	80,1	84,8	89,5	94,8	96,2	71,0	88,0	5,1	83,9	88,6	95,3	95,0	68,8	86,5	86,5	86,5	86,5	86,5	86,5	86,5	86,5	86,5	86,5	86,5	70
71	14,0	67,4	79,5	82,4	87,7	93,6	94,3	69,2	86,1	4,3	81,5	86,8	93,4	93,0	66,9	84,7	84,7	84,7	84,7	84,7	84,7	84,7	84,7	84,7	84,7	84,7	71
74	11,8	66,0	78,0	76,2	82,6	89,1	89,0	63,5	80,6	-	75,1	81,6	88,0	87,5	61,0	79,5	79,5	79,5	79,5	79,5	79,5	79,5	79,5	79,5	79,5	79,5	74
78	9,0	64,0	76,0	67,0	76,0	82,5	82,0	55,5	74,0	-	66,5	75,0	81,0	80,5	53,0	72,7	72,7	72,7	72,7	72,7	72,7	72,7	72,7	72,7	72,7	72,7	78
82	6,4	61,8	74,5	59,3	70,6	76,5	76,0	48,6	68,0	-	58,8	69,3	75,3	74,8	46,4	66,5	66,5	66,5	66,5	66,5	66,5	66,5	66,5	66,5	66,5	66,5	82
86	4,1	59,6	71,3	52,1	65,5	71,0	70,5	42,5	60,0	-	51,7	64,1	69,8	69,3	40,5	61,1	61,1	61,1	61,1	61,1	61,1	61,1	61,1	61,1	61,1	61,1	86
90	-	57,5	67,0	45,5	60,5	66,0	65,5	36,7	53,4	-	45,1	59,5	64,5	64,0	34,4	55,4	55,4	55,4	55,4	55,4	55,4	55,4	55,4	55,4	55,4	55,4	90
94	-	54,8	62,6	39,7	56,1	61,3	61,1	32,0	48,3	-	39,3	55,0	60,0	59,5	29,4	49,2	49,2	49,2	49,2	49,2	49,2	49,2	49,2	49,2	49,2	49,2	94
98	-	52,3	58,6	35,0	52,2	56,3	56,6	27,8	43,5	-	34,5	51,1	56,0	55,5	25,1	44,3	44,3	44,3	44,3	44,3	44,3	44,3	44,3	44,3	44,3	44,3	98
102	-	50,0	55,0	30,2	48,7	51,0	53,0	24,0	39,1	-	29,6	47,5	52,0	51,5	21,3	39,6	39,6	39,6	39,6	39,6	39,6	39,6	39,6	39,6	39,6	39,6	102
106	-	47,8	51,6	26,1	44,3	46,1	49,4	21,0	35,1	-	25,5	43,4	48,6	48,1	18,2	35,4	35,4	35,4	35,4	35,4	35,4	35,4	35,4	35,4	35,4	35,4	106
110	-	45,5	48,4	22,7	40,0	41,6	45,5	18,5	31,6	-	21,9	39,2	44,9	44,4	15,4	31,7	31,7	31,7	31,7	31,7	31,7	31,7	31,7	31,7	31,7	31,7	110
114	-	43,1	44,6	19,9	35,8	37,6	41,3	16,5	28,5	-	18,7	34,9	40,7	40,4	13,3	28,3	28,3	28,3	28,3	28,3	28,3	28,3	28,3	28,3	28,3	28,3	114
118	-	40,6	40,4	17,5	32,2	34,3	37,5	15,3	25,7	-	16,2	31,2	36,8	36,5	11,8	25,3	25,3	25,3	25,3	25,3	25,3	25,3	25,3	25,3	25,3	25,3	118
121	-	38,8	37,3	16,1	29,6	32,0	34,7	14,6	23,9	-	14,6	28,5	34,1	33,8	10,9	23,4	23,4	23,4	23,4	23,4	23,4	23,4	23,4	23,4	23,4	23,4	121
122	-	-	-	-	-	-	-	-	-	-	14,1	27,7	33,2	32,9	10,7	22,8	22,8	22,8	22,8	22,8	22,8	22,8	22,8	22,8	22,8	22,8	122
124	-	-	-	-	-	-	-	-	-	-	13,3	26,0	31,5	31,2	10,3	21,6	21,6	21,6	21,6	21,6	21,6	21,6	21,6	21,6	21,6	21,6	124



225 t																	
11-19 m						12 m x 12 m						9.8 m/s		360°		ISO	
144 m									147 m								
LSL_1			LSL_2		LSL_5		LSL_7		LSL_9		LSL_11		LSL_13		LSL_15		
0 t			0t-325t									0 t			0t-325t		
m	t	t	t	t	t	t	t	t	t	t	t	t	t	t	t	t	m
16	74,0	77,0	87,5	104,0	109,0	130,0	137,0	147,0	161,0	96,0	99,5	104,0	123,0	130,0	140,0	153,0	16
18	73,5	76,5	87,0	104,0	109,0	129,0	137,0	146,0	161,0	96,0	99,0	103,0	123,0	130,0	140,0	153,0	18
20	73,5	75,5	87,0	104,0	109,0	129,0	137,0	146,0	161,0	96,0	98,5	103,0	123,0	130,0	139,0	153,0	20
22	73,0	75,0	86,5	104,0	108,0	129,0	137,0	145,0	161,0	96,0	98,5	102,0	123,0	130,0	139,0	153,0	22
24	72,5	74,0	86,0	103,0	108,0	128,0	136,0	145,0	160,0	96,0	98,0	102,0	122,0	129,0	139,0	152,0	24
26	71,5	73,5	85,5	103,0	108,0	128,0	135,0	144,0	159,5	95,0	98,0	102,0	122,0	129,0	138,0	151,5	26
28	71,0	73,0	85,0	103,0	107,0	128,0	134,0	143,0	159,0	88,0	97,5	101,0	122,0	128,0	137,0	151,0	28
30	70,5	72,5	84,0	102,0	106,0	127,0	133,0	143,0	158,5	80,0	97,0	101,0	121,0	127,0	136,0	150,5	30
34	68,3	70,8	82,6	101,3	104,6	125,6	131,0	140,0	156,5	67,6	96,0	99,3	119,6	125,0	134,0	148,5	34
38	62,1	69,0	81,5	100,3	103,3	123,6	128,0	137,0	153,5	55,8	95,0	98,3	118,0	122,6	131,3	146,0	38
42	52,5	67,0	80,5	99,0	102,0	121,0	124,0	133,0	148,6	44,6	94,0	97,0	116,0	120,0	128,0	142,3	42
46	44,2	65,3	79,1	97,0	99,3	118,3	118,6	125,6	143,0	36,0	92,6	95,0	113,0	115,3	121,0	137,0	46
50	36,8	63,6	77,6	95,1	95,8	115,6	114,0	120,3	134,3	28,4	91,0	92,5	110,6	111,6	116,6	130,3	50
54	30,4	62,0	76,0	93,5	93,5	113,0	110,0	116,0	125,0	21,8	89,0	90,5	108,0	109,0	112,0	121,6	54
58	25,2	60,0	74,6	91,1	89,8	110,3	105,0	111,0	115,0	16,6	87,3	87,6	105,3	104,6	107,6	112,0	58
62	20,6	58,1	73,0	89,1	86,5	107,3	100,5	106,6	104,6	11,9	85,6	84,8	102,6	100,6	103,0	102,6	62
66	16,5	56,5	71,0	87,5	83,5	104,0	97,0	102,0	95,1	7,7	84,0	82,5	100,0	97,5	99,0	93,6	66
70	13,1	54,8	68,6	82,0	79,9	95,3	91,6	94,0	86,5	4,1	79,5	79,5	93,6	92,5	91,6	85,0	70
74	10,2	53,1	66,8	76,0	76,5	88,0	86,1	86,5	79,1	-	73,5	76,0	87,0	86,5	84,3	78,0	74
78	7,8	51,5	65,5	70,0	73,5	81,0	80,5	79,5	72,5	-	67,5	73,0	80,0	79,5	77,0	71,0	78
82	5,2	50,1	63,3	64,3	70,1	75,3	74,8	73,5	66,5	-	61,8	69,3	74,0	73,5	70,3	65,0	82
84	4,0	49,5	62,5	61,5	68,5	72,5	72,0	70,5	63,8	-	59,0	67,5	71,0	70,5	67,0	62,3	84
86	-	48,7	61,6	59,0	66,1	69,8	69,3	67,6	61,1	-	56,3	65,0	68,5	68,0	63,8	59,6	86
90	-	47,2	60,0	54,0	61,5	64,5	64,0	62,0	56,1	-	51,0	60,0	63,5	63,0	57,5	54,6	90
94	-	45,1	57,0	48,8	57,1	60,0	59,1	56,6	51,5	-	46,1	56,0	58,7	58,2	52,0	50,0	94
98	-	43,5	54,0	43,3	53,0	56,0	53,5	51,5	47,5	-	41,0	51,6	54,5	53,5	46,8	46,1	98
102	-	42,1	51,0	37,5	46,2	52,0	47,7	46,7	43,7	-	36,0	46,9	50,5	48,5	41,9	42,4	102
106	-	40,7	47,8	32,5	39,6	48,4	42,5	42,4	40,1	-	31,1	40,1	47,2	42,9	37,5	38,8	106
110	-	39,4	44,6	27,8	33,6	44,6	37,7	38,4	36,9	-	26,7	34,0	43,5	37,8	33,3	35,6	110
114	-	38,1	41,4	23,7	28,4	40,4	33,3	34,6	33,8	-	22,5	28,5	39,5	33,1	29,7	32,5	114
118	-	36,7	38,1	20,3	24,3	36,5	29,5	31,3	31,0	-	19,0	24,5	35,7	29,1	26,5	29,7	118
122	-	35,4	34,9	17,3	20,8	32,9	26,4	28,3	28,3	-	15,9	20,9	32,0	25,6	23,6	27,0	122
126	-	34,1	31,7	14,8	18,1	29,5	23,6	25,6	25,4	-	13,2	17,6	28,6	22,4	21,1	24,1	126
127	-	33,7	30,9	14,3	17,6	28,7	23,0	25,0	24,6	-	12,6	16,9	27,8	21,7	20,6	23,3	127
129	-	-	-	-	-	-	-	-	-	-	11,5	15,5	26,2	20,4	19,6	21,8	129

0t
65t
125t
165t
205t
245t
285t
325t

225 t															
11-19 m															
12 m x 12 m															
9.8 m/s															
360°															
ISO															
150 m															
153 m															
LSL_5 LSL_7 LSL_9 LSL_11 LSL_13 LSL_15 LSL_5 LSL_7 LSL_9 LSL_11 LSL_13 LSL_15															
0 t 0t-325t 0t 0t-325t															
m	t	t	t	t	t	t	t	t	t	t	t	t	t	t	m
16	90,0	93,0	98,5	117,0	123,0	133,0	145,0	-	-	-	-	-	-	-	16
17	90,0	92,7	98,2	116,5	123,0	133,0	145,0	85,5	88,0	93,0	111,0	117,0	126,0	137,0	17
18	90,0	92,5	98,0	116,0	123,0	133,0	145,0	85,5	88,0	93,0	111,0	117,0	126,0	137,0	18
20	90,0	92,0	97,5	116,0	123,0	132,0	145,0	85,5	87,5	92,5	111,0	116,0	126,0	137,0	20
22	90,0	91,5	97,0	116,0	122,0	132,0	145,0	85,0	87,0	92,0	111,0	116,0	126,0	137,0	22
24	90,0	91,5	96,5	116,0	122,0	132,0	145,0	85,0	87,0	92,0	110,0	116,0	126,0	137,0	24
26	89,5	91,0	96,5	115,0	122,0	132,0	144,0	85,0	86,5	91,5	110,0	116,0	125,0	136,0	26
28	87,5	90,5	96,0	115,0	121,0	131,0	143,0	84,0	86,5	91,0	110,0	115,0	124,0	135,0	28
30	80,5	90,0	95,5	115,0	120,0	130,0	142,5	78,5	86,0	90,5	109,0	114,0	124,0	134,5	30
34	67,8	88,6	94,1	113,3	118,6	128,0	141,0	66,1	84,6	89,8	107,6	112,6	122,0	133,5	34
38	56,2	87,5	93,0	112,0	116,6	125,3	139,0	54,8	83,6	89,0	106,3	111,0	119,6	132,0	38
42	45,6	86,5	92,0	110,0	114,0	122,0	135,3	44,6	83,0	88,0	105,0	109,0	118,0	128,6	42
46	37,0	84,8	90,0	107,3	110,0	116,0	130,0	35,9	81,6	86,3	102,3	105,3	111,6	124,0	46
50	29,4	83,1	88,3	105,0	106,6	112,0	124,6	28,3	80,1	84,8	99,8	102,1	107,3	119,3	50
54	22,8	81,5	87,0	103,0	104,0	108,0	118,0	21,7	78,5	83,5	97,5	99,5	104,0	115,0	54
58	17,6	79,8	84,5	100,6	100,3	103,0	110,0	16,5	77,1	81,8	94,8	96,5	99,6	106,0	58
62	12,9	77,6	81,8	98,3	97,5	100,0	101,6	11,8	75,6	79,6	92,5	93,5	95,8	98,6	62
66	8,7	76,0	79,5	95,5	93,5	95,5	93,1	7,6	74,0	78,0	90,0	91,0	92,0	91,0	66
70	5,1	73,5	76,5	91,5	89,1	89,1	84,5	4,0	72,0	75,5	86,6	86,0	87,0	83,0	70
71	4,3	72,7	75,7	90,5	88,0	87,5	82,6	-	71,2	75,0	85,8	85,0	85,7	81,2	71
74	-	70,5	73,0	86,0	84,1	82,3	77,1	-	68,8	72,0	82,1	81,0	80,5	75,8	74
78	-	68,5	70,0	79,0	78,5	75,0	70,5	-	65,5	69,0	76,5	75,0	72,5	69,0	78
82	-	66,1	67,3	73,0	72,5	68,0	64,5	-	62,1	66,0	71,1	69,3	65,5	63,0	82
86	-	63,5	63,8	67,5	67,0	61,5	59,1	-	59,0	62,3	65,9	63,5	58,5	57,6	86
90	-	60,5	59,5	62,5	62,0	55,5	54,1	-	56,0	58,0	60,5	57,5	52,0	52,7	90
94	-	56,1	55,0	57,8	56,6	49,9	49,5	-	53,0	53,7	55,1	51,9	46,3	48,2	94
98	-	51,1	50,8	53,6	51,1	44,6	45,3	-	48,7	49,7	49,5	46,2	40,9	43,9	98
102	-	45,5	46,5	50,0	45,3	39,6	41,6	-	43,1	46,3	43,6	40,6	35,7	39,5	102
106	-	38,2	39,1	45,8	39,9	35,2	38,0	-	36,2	39,1	38,2	35,4	31,1	35,1	106
110	-	31,5	32,3	41,5	34,8	30,9	34,8	-	29,9	32,5	33,0	30,6	26,8	31,0	110
114	-	25,7	26,3	37,1	30,2	27,2	31,5	-	24,2	26,3	28,2	26,2	22,9	27,2	114
118	-	21,5	21,8	33,1	26,2	23,9	28,2	-	19,9	21,3	24,0	22,2	19,6	23,7	118
122	-	18,1	18,3	29,3	22,5	20,9	25,0	-	16,1	17,5	20,2	18,6	16,7	20,5	122
126	-	14,9	15,3	25,8	19,3	18,4	22,2	-	12,9	14,5	16,9	15,4	14,1	17,6	126
130	-	12,2	12,4	22,5	16,5	16,3	19,6	-	10,2	11,5	14,3	12,6	12,1	15,0	130
132	-	10,9	11,0	21,0	15,3	15,3	18,5	-	8,9	10,1	13,0	11,4	11,2	13,9	132
134	-	-	-	-	-	-	-	-	7,8	8,8	11,7	10,2	10,4	12,8	134

0t
65t
125t
165t
205t
245t
285t
325t

225 t		11-19 m						12 m x 12 m						9.8 m/s		360°		ISO									
156 m														159 m													
LSL_5		LSL_7		LSL_9		LSL_11		LSL_13		LSL_15		LSL_5		LSL_7		LSL_9		LSL_11		LSL_13		LSL_15					
0 t		0t-325t												0 t		0t-325t											
m	t	t	t	t	t	t	t	t	t	t	t	t	t	t	t	t	t	t	t	t	t	t	m				
17	78,5	81,0	87,5	105,0	111,0	120,0	131,0	74,5	77,0	83,0	100,0	105,0	113,0	125,0	17												
18	78,5	81,0	87,5	105,0	111,0	120,0	131,0	74,5	77,0	83,0	100,0	105,0	112,0	125,0	18												
20	78,5	80,5	87,0	105,0	111,0	120,0	131,0	74,5	76,5	82,5	99,5	104,0	112,0	124,0	20												
22	78,5	80,5	87,0	105,0	111,0	120,0	131,0	74,5	76,5	82,5	99,5	104,0	112,0	124,0	22												
24	78,5	80,0	86,5	104,0	110,0	120,0	131,0	74,0	76,0	82,0	99,0	104,0	111,0	124,0	24												
26	78,0	79,5	86,0	103,0	109,0	119,0	130,0	74,0	75,5	81,5	98,5	103,0	111,0	123,5	26												
28	78,0	79,0	86,0	102,0	108,0	119,0	129,0	73,5	75,5	81,5	98,0	102,0	110,0	123,0	28												
30	77,0	78,5	85,5	101,0	107,0	118,0	129,0	73,5	75,0	81,0	97,5	101,0	109,0	122,0	30												
34	65,1	77,5	84,5	99,0	105,0	116,6	128,0	63,3	74,0	80,0	95,8	99,3	107,0	121,0	34												
38	54,5	76,5	83,6	96,6	102,5	114,6	126,0	53,5	73,0	79,1	94,0	97,1	105,0	119,0	38												
42	44,6	75,5	83,0	94,0	99,5	113,0	123,3	43,5	72,0	78,5	92,0	94,5	103,0	116,6	42												
46	35,9	74,1	81,6	91,0	95,8	107,3	120,0	34,8	71,0	77,5	89,3	91,5	99,3	114,0	46												
50	28,3	72,8	80,3	87,8	92,3	103,3	116,0	27,2	69,8	76,1	86,8	88,5	95,3	110,6	50												
54	21,7	71,5	79,0	84,5	89,0	100,0	112,0	20,6	68,5	74,5	84,5	85,5	92,0	107,0	54												
58	16,5	70,1	77,3	81,1	85,1	97,0	107,0	15,4	67,5	73,1	81,3	82,0	88,4	104,0	58												
62	11,8	68,8	75,8	77,7	81,2	93,0	99,6	10,7	66,3	71,9	78,8	78,8	84,8	98,0	62												
66	7,6	67,5	74,5	74,5	78,0	90,0	92,3	6,5	65,0	70,5	76,0	75,5	81,5	91,6	66												
68	5,8	66,2	73,6	72,3	76,1	87,1	88,6	4,7	64,2	69,8	74,3	74,0	79,0	88,3	68												
70	4,0	65,2	72,8	70,6	74,3	85,3	85,0	-	63,6	69,1	73,1	72,5	77,5	85,0	70												
74	-	63,3	70,5	66,3	69,5	79,5	78,0	-	61,8	67,1	69,1	68,3	72,0	77,6	74												
78	-	61,0	67,5	61,0	64,0	71,5	71,0	-	59,5	64,5	64,0	63,0	64,0	70,9	78												
82	-	59,0	64,5	55,5	58,6	64,1	65,0	-	57,3	61,8	58,6	57,5	56,0	64,5	82												
86	-	57,1	61,1	50,2	53,3	57,3	59,6	-	55,3	58,9	53,2	51,7	49,3	59,1	86												
90	-	55,5	57,5	44,8	48,2	51,0	54,6	-	53,0	56,0	48,5	46,1	41,9	54,2	90												
94	-	53,5	53,2	39,4	42,6	44,8	50,0	-	51,0	52,0	43,1	40,3	35,3	49,8	94												
98	-	50,6	49,2	34,3	37,4	39,2	45,5	-	48,6	48,1	37,8	34,6	29,2	45,7	98												
102	-	46,8	45,7	29,3	32,3	33,9	40,9	-	46,0	44,5	32,6	29,4	24,0	41,3	102												
106	-	40,5	39,7	24,8	27,7	29,1	36,3	-	39,0	38,8	27,6	24,8	19,1	36,6	106												
110	-	34,6	33,7	20,5	23,2	24,9	32,2	-	32,6	32,8	23,0	20,6	14,8	32,2	110												
114	-	29,1	27,9	16,6	19,2	21,4	28,3	-	26,6	26,8	18,6	16,6	10,8	28,3	114												
118	-	24,4	22,9	13,1	15,6	17,9	24,7	-	21,5	21,6	14,7	13,0	7,4	24,5	118												
122	-	20,3	18,8	9,9	12,2	14,7	21,4	-	17,2	17,1	11,1	9,7	4,4	21,1	122												
126	-	16,6	15,3	7,0	9,3	11,9	18,4	-	13,7	13,5	7,8	6,8	-	17,9	126												
130	-	13,4	12,2	4,5	6,7	9,8	15,7	-	10,4	10,6	5,0	4,1	-	15,1	130												
131	-	12,6	11,7	-	6,1	9,3	15,1	-	9,6	10,0	4,3	-	-	14,4	131												
134	-	10,3	9,7	-	4,4	8,0	13,3	-	7,6	8,0	-	-	-	12,5	134												
137	-	8,0	7,6	-	-	7,0	11,7	-	5,6	6,0	-	-	-	10,7	137												
138	-	-	-	-	-	-	-	-	5,0	5,4	-	-	-	10,2	138												
139	-	-	-	-	-	-	-	-	4,4	4,7	-	-	-	9,7	139												
140	-	-	-	-	-	-	-	-	4,1	4,1	-	-	-	9,2	140												



225 t		11-19 m				12 m x 12 m				9.8 m/s		360°		ISO			
162 m		165 m				168 m				171 m							
LSL_9		LSL_11		LSL_13		LSL_15		LSL_9		LSL_11		LSL_13		LSL_15			
0 t		0t-325t				0 t		0t-325t				0 t		0t-325t			
m	t	t	t	t	t	t	t	t	t	t	t	t	t	t	t	t	m
18	92,0	94,0	99,0	107,0	118,0	86,5	88,5	93,5	101,0	112,0	92,5	94,5	107,0	87,0	89,5	100,0	18
20	92,0	94,0	98,5	107,0	118,0	86,5	88,0	93,0	101,0	112,0	92,5	94,5	107,0	87,0	89,0	100,0	20
22	91,5	93,5	98,5	106,0	118,0	86,5	88,0	93,0	100,0	112,0	92,0	94,5	107,0	86,5	89,0	100,0	22
24	91,5	93,0	98,0	106,0	118,0	86,0	87,5	93,0	100,0	111,0	91,0	94,0	106,0	86,5	88,5	99,5	24
26	89,0	93,0	98,0	106,0	117,5	85,0	87,0	92,5	100,0	110,5	84,5	94,0	105,5	82,0	88,5	99,2	26
28	80,5	92,5	97,5	105,0	117,0	78,5	87,0	92,0	100,0	110,0	76,0	93,5	105,0	74,0	88,0	99,0	28
30	73,0	92,5	96,5	105,0	116,0	71,0	86,5	92,0	99,5	109,5	68,5	93,0	104,5	66,5	88,0	98,2	30
34	60,6	91,1	94,8	103,0	114,5	59,0	85,8	90,6	98,8	108,5	56,5	92,6	103,5	54,8	87,3	97,2	34
38	48,7	89,5	93,0	101,1	113,5	47,3	85,0	89,1	97,8	107,0	45,0	91,6	102,5	43,5	86,3	96,2	38
42	37,3	88,0	91,0	99,5	111,6	36,1	84,0	87,5	96,5	105,0	34,0	90,0	101,1	32,7	85,0	94,6	42
46	28,7	85,6	88,3	96,5	109,0	27,5	82,3	85,1	93,8	103,0	25,3	88,0	99,5	24,1	83,6	93,5	46
50	21,1	83,5	85,6	92,5	106,0	19,9	80,6	83,0	91,1	100,5	17,7	86,0	97,0	16,2	82,0	90,7	50
51	19,4	83,0	85,0	91,5	105,0	18,2	80,2	82,5	90,2	100,0	16,1	85,5	96,5	14,5	81,5	90,0	51
54	14,5	81,5	83,0	89,5	102,6	13,3	79,0	81,0	88,5	98,1	11,2	84,0	94,6	-	80,0	88,1	54
58	9,3	79,1	80,3	86,3	100,0	8,1	77,3	78,5	86,0	95,5	5,9	81,6	92,0	-	78,0	85,5	58
59	8,0	78,5	79,6	85,5	98,7	6,8	76,9	78,0	85,5	94,5	4,6	81,0	91,2	-	77,5	84,9	59
61	5,6	77,3	78,2	84,2	96,2	4,4	76,5	76,9	84,4	92,5	-	79,9	89,7	-	76,5	83,7	61
62	4,5	76,6	77,5	83,5	95,0	-	76,1	76,3	83,8	91,5	-	79,3	89,0	-	76,0	83,1	62
66	-	74,5	75,0	80,5	89,3	-	74,5	74,0	81,5	86,3	-	77,0	84,3	-	74,0	79,8	66
70	-	72,1	72,3	76,0	83,0	-	72,8	71,5	79,0	80,0	-	75,0	78,0	-	72,0	75,5	70
74	-	68,5	68,3	71,7	76,3	-	70,3	68,6	75,6	74,8	-	72,6	72,5	-	70,0	70,1	74
78	-	64,5	64,0	65,5	70,0	-	67,0	65,0	71,0	68,8	-	70,0	67,3	-	68,0	65,1	78
82	-	59,3	58,5	57,5	64,0	-	62,3	59,0	63,0	62,5	-	63,4	62,0	-	62,2	60,5	82
86	-	54,4	52,8	50,1	58,6	-	57,6	53,2	55,5	57,1	-	57,0	56,6	-	56,6	55,1	86
90	-	49,3	47,5	44,1	53,7	-	53,0	47,8	48,6	52,2	-	51,0	51,7	-	51,0	50,3	90
94	-	44,1	42,1	37,4	49,1	-	48,2	42,1	42,0	47,8	-	45,2	47,1	-	45,8	45,9	94
98	-	39,0	36,6	31,2	44,6	-	43,3	36,5	35,6	43,7	-	39,8	41,5	-	40,7	40,5	98
102	-	34,0	31,2	25,6	39,2	-	38,5	30,7	29,8	39,1	-	34,5	35,4	-	35,8	34,5	102
106	-	28,7	26,3	20,7	34,0	-	33,2	25,6	24,9	34,0	-	29,7	28,7	-	31,0	28,1	106
110	-	23,8	21,8	16,6	29,8	-	28,0	21,1	20,5	29,7	-	25,1	24,6	-	26,5	23,4	110
114	-	19,2	17,6	13,1	25,8	-	23,0	16,8	16,3	25,6	-	20,8	20,7	-	22,9	19,6	114
118	-	15,1	13,8	9,7	22,1	-	18,4	12,9	12,6	21,7	-	16,8	17,1	-	19,0	16,0	118
122	-	11,2	10,1	6,5	18,7	-	14,2	9,3	9,2	18,2	-	13,5	13,8	-	15,3	12,6	122
125	-	8,6	7,7	4,4	16,2	-	11,3	6,7	6,8	15,7	-	10,9	11,4	-	12,6	10,2	125
126	-	7,8	6,9	-	15,5	-	10,4	5,9	6,1	14,9	-	10,1	10,7	-	11,8	9,5	126
128	-	6,2	5,4	-	14,0	-	8,7	4,4	4,7	13,4	-	8,5	9,2	-	10,1	8,0	128
129	-	5,4	4,7	-	13,3	-	7,9	-	4,0	12,6	-	7,7	8,5	-	9,3	7,3	129
130	-	4,7	4,0	-	12,6	-	7,0	-	-	11,9	-	6,9	7,8	-	8,5	6,6	130
131	-	4,0	-	-	11,9	-	6,2	-	-	11,2	-	6,2	7,1	-	7,7	5,9	131
133	-	-	-	-	10,7	-	4,7	-	-	9,9	-	4,8	5,8	-	6,1	4,6	133
134	-	-	-	-	10,1	-	4,0	-	-	9,2	-	4,2	5,2	-	5,3	-	134
135	-	-	-	-	9,5	-	-	-	-	8,5	-	-	4,6	-	4,6	-	135
138	-	-	-	-	7,7	-	-	-	-	6,8	-	-	-	-	-	-	138
142	-	-	-	-	5,7	-	-	-	-	4,6	-	-	-	-	-	-	142
143	-	-	-	-	-	-	-	-	-	4,1	-	-	-	-	-	-	143

	0t	65t	125t	165t	205t	245t	285t	325t
---	----	-----	------	------	------	------	------	------

Notes

PC 3800-1

Notizen · Notes · Nota · Notas · Notas ·
пометы, комментарии, примечания

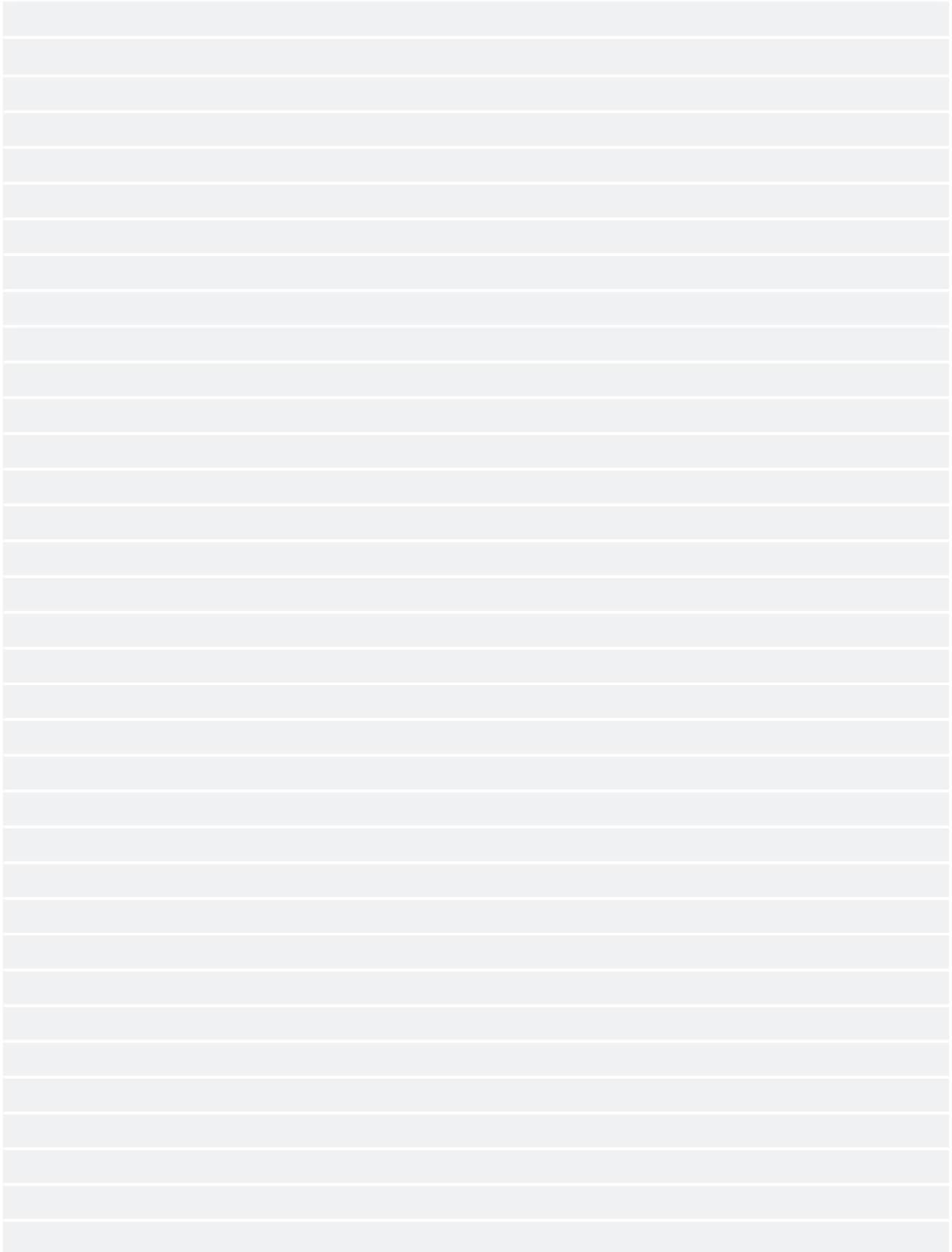

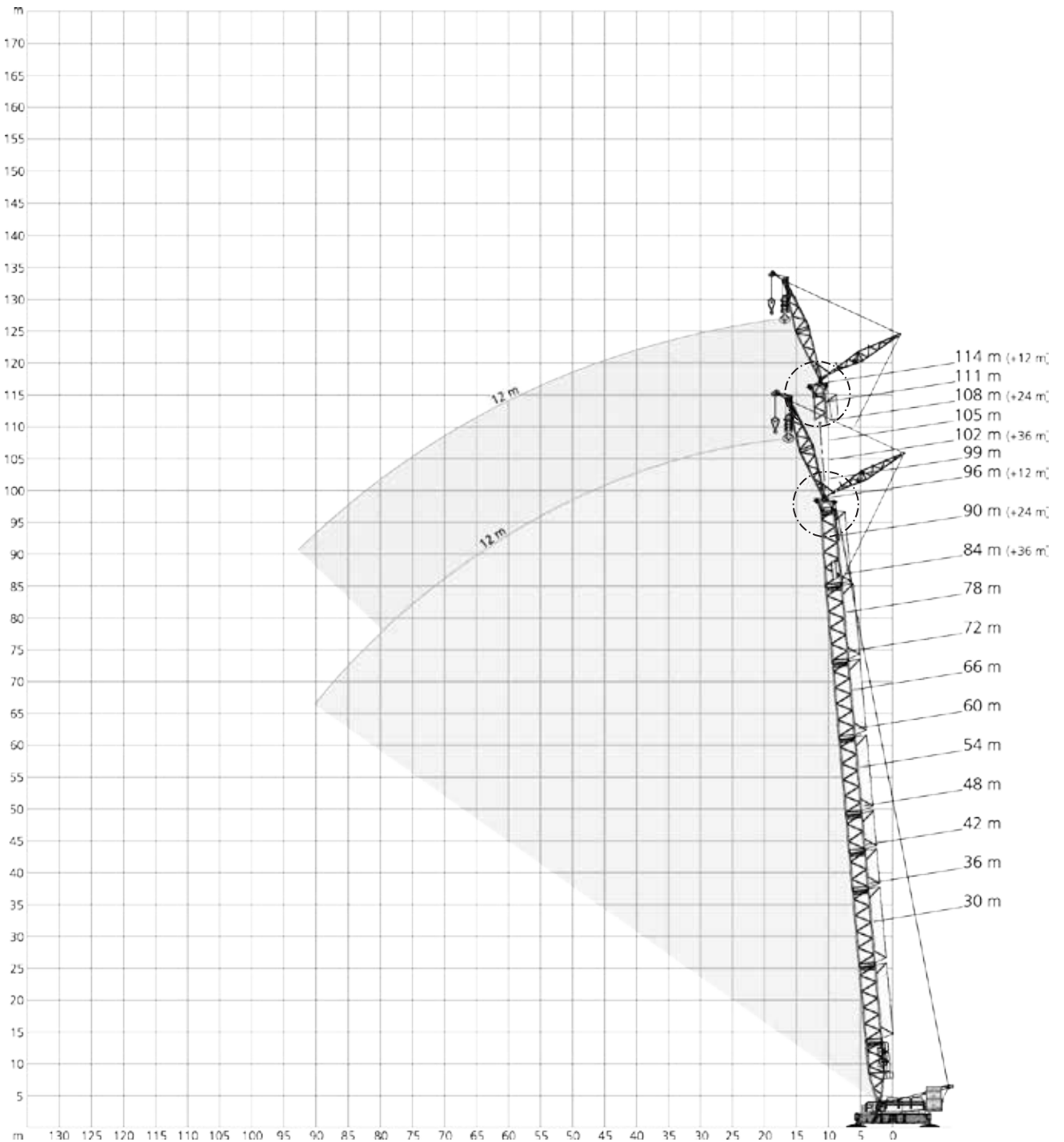
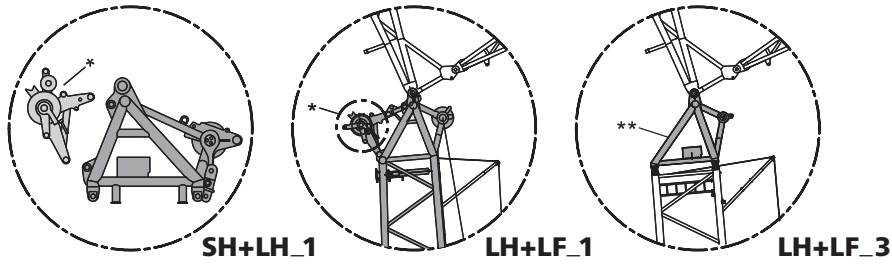

* Attachable · Anbaubar · Amovible · Montabile · Acoplable · Adaptável · Приставн
 ** Option · Option · En option · Opzione · Orcion · Orcional · Опция

		12-36 m						12 m x 12 m			9.8 m/s			360°			ISO			
		30 m						12 m x 12 m									36 m			
		SH+LF_1																		
		12 m			24 m			36 m			12 m			24 m			36 m			
		15°	20°	30°	15°	20°	30°	15°	20°	30°	15°	20°	30°	15°	20°	30°	15°	20°	30°	
m	t	t	t	t	t	t	t	t	t	t	t	t	t	t	t	t	t	t	t	m
9	171,0	-	-	-	-	-	-	-	-	-	-	-	-	-	-	-	-	-	-	9
10	160,0	-	-	-	-	-	-	-	-	-	-	-	-	-	-	-	-	-	-	10
11	150,5	130,0	-	-	-	-	-	-	-	-	-	-	-	-	-	-	-	-	-	11
12	141,0	123,0	86,0	-	-	-	-	-	-	-	-	-	-	-	-	-	-	-	-	12
13	133,5	117,5	83,0	-	-	-	-	-	-	-	-	-	-	-	-	-	-	-	-	13
14	126,0	112,0	80,0	78,5	-	-	-	-	-	-	-	-	-	-	-	-	-	-	-	14
16	114,0	103,0	75,0	71,0	61,5	-	-	-	-	-	-	-	-	-	-	-	-	-	-	16
18	105,0	95,0	70,0	64,5	56,5	-	51,0	-	-	-	-	-	-	-	-	-	-	-	-	18
19	101,0	91,5	68,2	61,7	54,5	37,7	48,8	-	-	-	-	-	-	-	-	-	-	-	-	19
20	97,0	88,0	66,5	59,0	52,5	36,6	46,7	-	-	-	-	-	-	-	-	-	-	-	-	20
21	93,5	85,5	64,7	56,7	50,7	35,5	44,8	37,3	-	-	-	-	-	-	-	-	-	-	-	21
22	90,0	83,0	63,0	54,5	48,9	34,5	42,9	36,0	-	-	-	-	-	-	-	-	-	-	-	22
24	84,0	78,5	60,0	50,5	45,6	32,7	39,7	33,6	-	-	-	-	-	-	-	-	-	-	-	24
26	78,5	74,0	57,5	47,5	42,8	31,0	36,8	31,5	22,0	-	-	-	-	-	-	-	-	-	-	26
27	76,5	72,2	56,2	46,0	41,6	30,2	35,6	30,5	21,4	-	-	-	-	-	-	-	-	-	-	27
28	74,5	70,5	55,0	44,5	40,4	29,5	34,4	29,5	20,8	-	-	-	-	-	-	-	-	-	-	28
30	70,5	67,0	53,0	41,9	38,4	28,2	32,2	27,8	19,8	-	-	-	-	-	-	-	-	-	-	30
34	64,0	61,5	50,0	37,5	34,8	26,0	28,5	24,8	17,9	-	-	-	-	-	-	-	-	-	-	34
35	62,7	60,5	49,8	36,6	34,0	25,5	27,7	24,2	17,5	-	-	-	-	-	-	-	-	-	-	35
38	59,0	57,5	-	34,0	31,8	24,2	25,6	22,6	16,4	-	-	-	-	-	-	-	-	-	-	38
39	58,0	-	-	33,2	31,2	23,8	25,0	22,1	16,1	-	-	-	-	-	-	-	-	-	-	39
40	57,0	-	-	32,5	30,6	23,5	24,4	21,6	15,8	-	-	-	-	-	-	-	-	-	-	40
42	-	-	-	31,1	29,4	22,8	23,2	20,7	15,2	-	-	-	-	-	-	-	-	-	-	42
43	-	-	-	30,5	28,9	22,5	22,6	20,2	14,9	-	-	-	-	-	-	-	-	-	-	43
45	-	-	-	29,3	27,9	21,9	21,6	19,4	14,3	-	-	-	-	-	-	-	-	-	-	45
46	-	-	-	28,8	27,4	21,7	21,1	19,0	14,1	-	-	-	-	-	-	-	-	-	-	46
47	-	-	-	28,3	27,0	21,5	20,6	18,6	13,8	-	-	-	-	-	-	-	-	-	-	47
50	-	-	-	27,0	26,1	-	19,4	17,6	13,2	-	-	-	-	-	-	-	-	-	-	50
51	-	-	-	26,6	-	-	19,0	17,3	13,0	-	-	-	-	-	-	-	-	-	-	51
54	-	-	-	-	-	-	18,0	16,4	12,5	-	-	-	-	-	-	-	-	-	-	54
55	-	-	-	-	-	-	17,7	16,1	12,3	-	-	-	-	-	-	-	-	-	-	55
56	-	-	-	-	-	-	17,4	15,9	12,2	-	-	-	-	-	-	-	-	-	-	56
58	-	-	-	-	-	-	16,8	15,5	12,0	-	-	-	-	-	-	-	-	-	-	58
62	-	-	-	-	-	-	15,9	14,9	-	-	-	-	-	-	-	-	-	-	-	62
63	-	-	-	-	-	-	15,7	-	-	-	-	-	-	-	-	-	-	-	-	63
66	-	-	-	-	-	-	-	-	-	-	-	-	-	-	-	-	-	-	-	66
67	-	-	-	-	-	-	-	-	-	-	-	-	-	-	-	-	-	-	-	67
68	-	-	-	-	-	-	-	-	-	-	-	-	-	-	-	-	-	-	-	68

25t 65t 105t 145t 185t 225t

		12-36 m						12 m x 12 m			9.8 m/s			360°			ISO			
		48 m						12 m x 12 m									54 m			
		SH+LF_1																		
		12 m			24 m			36 m			12 m			24 m			36 m			
		15°	20°	30°	15°	20°	30°	15°	20°	30°	15°	20°	30°	15°	20°	30°	15°	20°	30°	
m	t	t	t	t	t	t	t	t	t	t	t	t	t	t	t	t	t	t	t	m
11	167,0	-	-	-	-	-	-	-	-	-	-	-	-	-	-	-	-	-	-	11
12	159,0	136,0	-	-	-	-	-	-	-	163,0	-	-	-	-	-	-	-	-	-	12
13	152,5	131,5	-	-	-	-	-	-	-	156,5	134,0	-	-	-	-	-	-	-	-	13
14	146,0	127,0	84,0	-	-	-	-	-	-	150,0	129,0	85,0	-	-	-	-	-	-	-	14
15	140,0	122,5	82,0	81,0	-	-	-	-	-	144,5	125,0	83,0	-	-	-	-	-	-	-	15
16	134,0	118,0	80,0	78,0	-	-	-	-	-	139,0	121,0	81,0	79,5	-	-	-	-	-	-	16
17	129,0	114,5	78,2	75,0	62,0	-	-	-	-	134,5	117,5	79,2	76,7	-	-	-	-	-	-	17
18	124,0	111,0	76,5	72,0	60,0	-	-	-	-	130,0	114,0	77,5	74,0	60,5	-	-	-	-	-	18
19	120,0	107,5	74,7	69,5	58,2	-	51,5	-	-	125,5	111,0	76,0	71,5	59,0	-	-	-	-	-	19
20	116,0	104,0	73,0	67,0	56,5	-	49,7	-	-	121,0	108,0	74,5	69,0	57,5	-	50,0	-	-	-	20
21	112,5	101,2	71,5	64,7	55,0	36,7	48,0	-	-	117,5	105,0	73,0	66,7	56,0	36,9	48,5	-	-	-	21
22	109,0	98,5	70,0	62,5	53,5	35,9	46,4	37,3	-	114,0	102,0	71,5	64,5	54,5	36,2	47,1	-	-	-	22
23	105,5	96,0	68,5	60,5	52,0	35,1	44,9	36,2	-	111,0	99,7	70,2	62,5	53,0	35,5	45,7	36,5	-	-	23
24	102,0	93,5	67,0	58,5	50,5	34,4	43,5	35,2	-	108,0	97,5	69,0	60,5	51,5	34,8	44,3	35,6	-	-	24
26	97,0	89,0	64,5	55,0	48,0	33,0	41,1	33,3	-	102,0	92,5	66,5	57,5	49,3	33,5	41,9	33,8	-	-	26
28	92,0	85,0	62,5	52,0	45,6	31,8	38,8	31,7	21,3	97,0	88,5	64,5	54,5	47,0	32,3	39,7	32,2	21,3	-	28
30	87,5	82,0	60,5	49,6	43,5	30,6	36,6	30,2	20,4	92,5	85,0	62,5	51,5	44,9	31,1	37,7	30,7	20,5	30	30
34	80,0	75,5	57,0	44,9	39,8	28,5	32,9	27,4	18,8	83,5	79,5	59,0	47,0	41,2	29,1	34,0	28,1	19,0	34	34
38	71,5	70,5	54,0	41,0	37,0	26,8	29,7	25,1	17,5	70,5	71,0	56,0	43,1	38,2	27,4	30,9	25,8	17,7	38	38
42	61,5	62,0	51,5	37,8	34,5	25,3	27,3	23,1	16,3	60,5	60,5	53,5	39,7	35,9	26,0	28,3	23,8	16,6	42	42
46	53,5	53,5	50,0	35,1	32,3	24,1	25,1	21,6	15,3	52,0	52,5	51,5	36,9	33,7	24,7	26,3	22,2	15,6	46	46
48	50,3	50,4	49,3	33,9	31,3	23,5	24,1	20,9	14,9	48,9	49,2	48,9	35,7	32,7	24,1	25,3	21,5	15,2	48	48
50	47,1	47,3	-	32,7	30,4	23,0	23,2	20,2	14,5	45,8	46,0	46,4	34,5	31,7	23,6	24,4	20,9	14,8	50	50
53	43,0	43,1	-	31,2	29,1	22,3	22,0	19,3	13,9	41,7	41,8	42,1	32,9	30,4	22,9	23,1	20,0	14,2	53	53
54	41,7	41,8	-	30,8	28,7	22,1	21,6	19,0	13,7	40,4	40,5	-	32,4	30,0	22,7	22,7	19,7	14,0	54	54
55	40,5	-	-	30,3	28,3	21,9	21,2	18,7	13,5	39,2	39,3	-	32,0	29,6	22,5	22,3	19,4	13,8	55	55
58	-	-	-	29,1	27,4	21,4	20,2	17,9	13,1	35,8	35,9	-	30,6	28,6	21,9	21,3	18,6	13,4	58	58
59	-	-	-	28,7	27,1	21,3	19,9	17,6	12,9	34,8	34,9	-	30,2	28,2	21,7	20,9	18,3	13,2	59	59
60	-	-	-	28,3	26,8	21,2	19,6	17,4	12,8	33,8	-	-	29,8	27,9	21,6	20,6	18,1	13,1	60	60
62	-	-	-	27,6	26,3	-	19,0	16,9	12,5	-	-	-	29,1	27,3	21,3	20,0	17,6	12,8	62	62
64	-	-	-	27,0	25,9	-	18,4	16,5	12,3	-	-	-	28,4	26,8	21,1	19,4	17,1	12,5	64	64
65	-	-	-	26,7	25,7	-	18,1	16,3	12,2	-	-	-	28,1	26,6	-	19,1	16,9	12,4	65	65
66	-	-	-	26,5	-	-	17,9	16,1	12,1	-	-	-	27,8	26,4	-	18,9	16,7	12,3	66	66
67	-	-	-	26,3	-	-	17,6	15,9	12,0	-	-	-	27,5	26,2	-	18,6	16,5	12,2	67	67
70	-	-	-	-	-	-	17,0	15,4	11,7	-	-	-	26,7	25,6	-	17,9	16,0	12,0	70	70
71	-	-	-	-	-	-	16,8	15,2	11,7	-	-	-	26,4	-	-	17,6	15,8	11,9	71	71
72	-	-	-	-	-	-	16,6	15,1	-	-	-	-	26,1	-	-	17,4	15,7	11,8	72	72
74	-	-	-	-	-	-	16,2	14,9	-	-	-	-	-	-	-	17,0	15,4	11,7	74	74
76	-	-	-	-	-	-	15,9	14,7	-	-	-	-	-	-	-	16,6	15,1	11,5	76	76
77	-	-	-	-	-	-	15,7	14,6	-	-	-	-	-	-	-	16,4	15,0	-	77	77
78	-	-	-	-	-	-	15,6	-	-	-	-	-	-	-	-	16,3	14,9	-	78	78
82	-	-	-	-	-	-	-	-	-	-	-	-	-	-	-	15,7	14,5	-	82	82
83	-	-	-	-	-	-	-	-	-	-	-	-	-	-	-	15,6	-	-	83	83

25t 65t 105t 145t 185t 225t

		12-36 m						12 m x 12 m			9.8 m/s			360°			ISO					
		60 m						12 m x 12 m									66 m					
		SH+LF_1																				
		12 m			24 m			36 m			12 m			24 m			36 m					
		15°	20°	30°	15°	20°	30°	15°	20°	30°	15°	20°	30°	15°	20°	30°	15°	20°	30°			
m	t	t	t	t	t	t	t	t	t	t	t	t	t	t	t	t	t	t	t	m		
12	167,0	-	-	-	-	-	-	-	-	-	-	-	-	-	-	-	-	-	-	12		
13	161,0	135,0	-	-	-	-	-	-	-	-	-	-	-	-	-	-	-	-	-	13		
14	155,0	131,0	-	-	-	-	-	-	-	-	-	-	-	-	-	-	-	-	-	14		
15	149,5	127,5	84,0	-	-	-	-	-	-	-	-	-	-	-	-	-	-	-	-	15		
16	144,0	124,0	82,0	81,0	-	-	-	-	-	-	-	-	-	-	-	-	-	-	-	16		
17	139,0	120,5	80,5	78,2	-	-	-	-	-	-	-	-	-	-	-	-	-	-	-	17		
18	134,0	117,0	79,0	75,5	61,5	-	-	-	-	-	-	-	-	-	-	-	-	-	-	18		
19	130,0	114,0	77,5	73,2	59,7	-	-	-	-	-	-	-	-	-	-	-	-	-	-	19		
20	126,0	111,0	76,0	71,0	58,0	-	50,5	-	-	-	-	-	-	-	-	-	-	-	-	20		
21	122,5	108,5	74,5	68,7	56,5	-	49,1	-	-	-	-	-	-	-	-	-	-	-	-	21		
22	119,0	106,0	73,0	66,5	55,0	36,4	47,8	-	-	-	-	-	-	-	-	-	-	-	-	22		
23	115,5	103,0	71,7	64,5	53,7	35,7	46,4	36,8	-	-	-	-	-	-	-	-	-	-	-	23		
24	112,0	100,0	70,5	62,5	52,5	35,1	45,1	35,9	-	-	-	-	-	-	-	-	-	-	-	24		
26	107,0	96,0	68,0	59,5	50,0	33,8	42,7	34,2	-	-	-	-	-	-	-	-	-	-	-	26		
28	101,0	92,0	66,0	56,5	48,2	32,7	40,6	32,6	-	-	-	-	-	-	-	-	-	-	-	28		
29	99,0	90,0	65,0	55,0	47,2	32,1	39,6	31,9	21,0	-	-	-	-	-	-	-	-	-	-	29		
30	97,0	88,0	64,0	53,5	46,2	31,6	38,6	31,2	20,6	-	-	-	-	-	-	-	-	-	-	30		
34	82,0	82,0	60,5	49,0	42,5	29,7	35,0	28,7	19,2	-	-	-	-	-	-	-	-	-	-	34		
38	69,0	69,5	57,5	45,0	39,4	28,0	31,9	26,4	17,9	-	-	-	-	-	-	-	-	-	-	38		
42	59,0	59,0	55,0	41,6	37,0	26,6	29,3	24,5	16,8	-	-	-	-	-	-	-	-	-	-	42		
46	50,5	51,0	51,5	38,7	34,9	25,4	27,2	22,8	15,9	-	-	-	-	-	-	-	-	-	-	46		
50	44,3	44,6	45,0	36,2	33,0	24,2	25,4	21,5	15,1	-	-	-	-	-	-	-	-	-	-	50		
54	38,8	39,0	39,4	34,0	31,2	23,3	23,7	20,3	14,3	-	-	-	-	-	-	-	-	-	-	54		
57	35,3	35,5	35,8	32,6	30,0	22,7	22,6	19,4	13,8	-	-	-	-	-	-	-	-	-	-	57		
58	34,2	34,4	-	32,2	29,7	22,5	22,2	19,2	13,7	-	-	-	-	-	-	-	-	-	-	58		
61	31,0	31,1	-	30,9	28,7	21,9	21,2	18,4	13,2	-	-	-	-	-	-	-	-	-	-	61		
62	30,0	30,1	-	30,5	28,4	21,8	20,9	18,2	13,1	-	-	-	-	-	-	-	-	-	-	62		
64	28,2	28,3	-	29,8	27,8	21,5	20,3	17,7	12,8	-	-	-	-	-	-	-	-	-	-	64		
65	27,3	-	-	29,4	27,5	21,3	20,0	17,5	12,7	-	-	-	-	-	-	-	-	-	-	65		
66	-	-	-	29,1	27,3	21,2	19,8	17,3	12,6	-	-	-	-	-	-	-	-	-	-	66		
69	-	-	-	26,7	26,4	20,9	19,0	16,7	12,3	-	-	-	-	-	-	-	-	-	-	69		
70	-	-	-	25,9	26,2	-	18,8	16,5	12,2	-	-	-	-	-	-	-	-	-	-	70		
71	-	-	-	25,1	25,4	-	18,5	16,3	12,1	-	-	-	-	-	-	-	-	-	-	71		
73	-	-	-	23,7	23,9	-	18,0	16,0	11,9	-	-	-	-	-	-	-	-	-	-	73		
74	-	-	-	23,0	23,2	-	17,8	15,9	11,8	-	-	-	-	-	-	-	-	-	-	74		
75	-	-	-	22,3	22,5	-	17,6	15,7	11,7	-	-	-	-	-	-	-	-	-	-	75		
77	-	-	-	21,0	-	-	-	17,2	15,4	11,6	-	-	-	-	-	-	-	-	-	77		
78	-	-	-	-	-	-	-	17,1	15,3	11,6	-	-	-	-	-	-	-	-	-	78		
80	-	-	-	-	-	-	-	16,7	15,1	11,5	-	-	-	-	-	-	-	-	-	80		
82	-	-	-	-	-	-	-	16,4	14,9	-	-	-	-	-	-	-	-	-	-	82		
85	-	-	-	-	-	-	-	15,9	14,6	-	-	-	-	-	-	-	-	-	-	85		
86	-	-	-	-	-	-	-	15,8	14,5	-	-	-	-	-	-	-	-	-	-	86		
87	-	-	-	-	-	-	-	15,6	14,4	-	-	-	-	-	-	-	-	-	-	87		
89	-	-	-	-	-	-	-	15,4	-	-	-	-	-	-	-	-	-	-	-	89		
90	-	-	-	-	-	-	-	-	-	-	-	-	-	-	-	-	-	-	-	90		
92	-	-	-	-	-	-	-	-	-	-	-	-	-	-	-	-	-	-	-	92		
94	-	-	-	-	-	-	-	-	-	-	-	-	-	-	-	-	-	-	-	94		

25t 65t 105t 145t 185t 225t

		12-36 m						12 m x 12 m			9.8 m/s			360°			ISO		
		72 m						12 m x 12 m									78 m		
		SH+LF_1																	
		12 m			24 m			36 m			12 m			24 m			36 m		
		15°	20°	30°	15°	20°	30°	15°	20°	30°	15°	20°	30°	15°	20°	30°	15°	20°	30°
m	t	t	t	t	t	t	t	t	t	t	t	t	t	t	t	t	t	t	m
13	167,0	-	-	-	-	-	-	-	-	-	-	-	-	-	-	-	-	-	13
14	162,0	134,0	-	-	-	-	-	-	-	-	-	-	-	-	-	-	-	-	14
15	156,5	130,5	-	-	-	-	-	-	-	-	-	-	-	-	-	-	-	-	15
16	151,0	127,0	83,5	-	-	-	-	-	-	-	-	-	-	-	-	-	-	-	16
17	146,5	124,0	82,0	81,0	-	-	-	-	-	-	-	-	-	-	-	-	-	-	17
18	142,0	121,0	80,5	78,5	-	-	-	-	-	-	-	-	-	-	-	-	-	-	18
19	138,0	118,5	79,0	76,2	60,5	-	-	-	-	-	-	-	-	-	-	-	-	-	19
20	134,0	116,0	77,5	74,0	59,0	-	-	-	-	-	-	-	-	-	-	-	-	-	20
21	130,5	113,5	76,2	72,0	57,7	-	50,0	-	-	-	-	-	-	-	-	-	-	-	21
22	127,0	111,0	75,0	70,0	56,5	-	48,7	-	-	-	-	-	-	-	-	-	-	-	22
23	124,0	108,5	74,0	68,0	55,2	36,0	47,4	-	-	-	-	-	-	-	-	-	-	-	23
24	121,0	106,0	73,0	66,0	54,0	35,5	46,1	36,3	-	-	-	-	-	-	-	-	-	-	24
25	118,0	104,0	71,7	64,5	53,0	34,9	45,0	35,5	-	-	-	-	-	-	-	-	-	-	25
26	115,0	102,0	70,5	63,0	52,0	34,3	43,9	34,7	-	-	-	-	-	-	-	-	-	-	26
28	109,0	97,5	68,5	60,0	50,0	33,3	41,8	33,3	-	-	-	-	-	-	-	-	-	-	28
30	97,5	94,0	67,0	57,0	48,2	32,3	40,0	31,9	20,6	-	-	-	-	-	-	-	-	-	30
31	93,1	90,6	66,1	55,8	47,3	31,8	39,1	31,3	20,3	-	-	-	-	-	-	-	-	-	31
34	80,0	80,5	63,5	52,5	44,7	30,5	36,7	29,6	19,4	-	-	-	-	-	-	-	-	-	34
38	67,0	67,5	60,5	48,4	41,7	28,9	33,7	27,5	18,2	-	-	-	-	-	-	-	-	-	38
42	56,5	57,0	58,0	45,0	39,1	27,6	31,1	25,6	17,2	-	-	-	-	-	-	-	-	-	42
46	48,7	49,1	49,8	42,0	37,0	26,4	28,9	24,0	16,3	-	-	-	-	-	-	-	-	-	46
50	42,0	42,3	42,9	39,3	35,3	25,3	27,0	22,5	15,5	-	-	-	-	-	-	-	-	-	50
54	36,3	36,6	37,2	37,1	33,7	24,3	25,5	21,4	14,8	-	-	-	-	-	-	-	-	-	54
58	31,3	31,6	32,1	34,8	32,1	23,5	24,1	20,3	14,2	-	-	-	-	-	-	-	-	-	58
62	27,0	27,3	27,7	30,4	30,6	22,7	22,7	19,3	13,6	-	-	-	-	-	-	-	-	-	62
66	23,4	23,6	23,9	26,6	27,1	22,1	21,5	18,4	13,1	-	-	-	-	-	-	-	-	-	66
70	20,2	20,4	-	23,2	23,7	21,5	20,4	17,6	12,6	-	-	-	-	-	-	-	-	-	70
74	17,5	17,6	-	20,3	20,7	21,1	19,4	16,9	12,2	-	-	-	-	-	-	-	-	-	74
76	16,2	-	-	19,0	19,3	19,8	18,9	16,5	12,0	-	-	-	-	-	-	-	-	-	76
77	-	-	-	18,3	18,6	19,2	18,7	16,3	11,9	-	-	-	-	-	-	-	-	-	77
78	-	-	-	17,7	18,0	-	18,5	16,2	11,9	-	-	-	-	-	-	-	-	-	78
79	-	-	-	17,1	17,4	-	18,2	16,0	11,8	-	-	-	-	-	-	-	-	-	79
81	-	-	-	15,9	16,2	-	17,6	15,8	11,6	-	-	-	-	-	-	-	-	-	81
82	-	-	-	15,4	15,6	-	17,4	15,7	11,6	-	-	-	-	-	-	-	-	-	82
85	-	-	-	13,8	14,0	-	15,8	15,3	11,4	-	-	-	-	-	-	-	-	-	85
86	-	-	-	13,3	-	-	15,3	15,2	11,4	-	-	-	-	-	-	-	-	-	86
87	-	-	-	12,8	-	-	14,8	14,8	11,3	-	-	-	-	-	-	-	-	-	87
89	-	-	-	-	-	-	13,8	14,0	11,3	-	-	-	-	-	-	-	-	-	89
90	-	-	-	-	-	-	13,3	13,6	-	-	-	-	-	-	-	-	-	-	90
91	-	-	-	-	-	-	12,8	13,1	-	-	-	-	-	-	-	-	-	-	91
93	-	-	-	-	-	-	11,9	12,2	-	-	-	-	-	-	-	-	-	-	93
94	-	-	-	-	-	-	11,5	11,8	-	-	-	-	-	-	-	-	-	-	94
97	-	-	-	-	-	-	10,3	10,5	-	-	-	-	-	-	-	-	-	-	97
98	-	-	-	-	-	-	9,9	-	-	-	-	-	-	-	-	-	-	-	98
99	-	-	-	-	-	-	9,5	-	-	-	-	-	-	-	-	-	-	-	99
102	-	-	-	-	-	-	-	-	-	-	-	-	-	-	-	-	-	-	102
104	-	-	-	-	-	-	-	-	-	-	-	-	-	-	-	-	-	-	104

25t 65t 105t 145t 185t 225t

12-36 m							12 m x 12 m / 14 m x 14 m			9.8 m/s			360°			ISO					
84 m							12 m x 12 m			SH+LF_1			84 m			14 m x 14 m			SH+LF_1		
12 m							24 m			36 m			15°			20°			30°		
m	t	t	t	t	t	t	m	t	t	t	m	t	t	t	m	t	t	t			
14	167,0	-	-	-	-	-	22	49,1	-	-	22	49,1	-	-	22	49,1	-	-			
15	162,5	-	-	-	-	-	24	46,8	-	-	24	46,8	-	-	24	46,8	-	-			
16	158,0	129,0	-	-	-	-	25	45,7	-	-	25	45,7	-	-	25	45,7	-	-			
17	153,5	126,5	83,0	-	-	-	26	44,7	35,0	-	26	44,7	35,0	-	26	44,7	35,0	-			
18	149,0	124,0	81,5	81,0	-	-	28	42,8	33,7	-	28	42,8	33,7	-	28	42,8	33,7	-			
20	141,0	119,0	79,0	76,5	60,0	-	30	41,0	32,4	-	30	41,0	32,4	-	30	41,0	32,4	-			
22	134,0	114,0	77,0	72,5	57,5	-	31	40,2	31,8	20,3	31	40,2	31,8	20,3	31	40,2	31,8	20,3			
24	127,0	110,0	74,5	69,0	55,0	35,7	34	37,9	30,2	19,4	34	37,9	30,2	19,4	34	37,9	30,2	19,4			
26	115,0	107,0	72,5	66,0	53,0	34,7	38	35,2	28,3	18,4	38	35,2	28,3	18,4	38	35,2	28,3	18,4			
28	105,0	103,0	71,0	63,0	51,5	33,7	42	32,7	26,5	17,5	42	32,7	26,5	17,5	42	32,7	26,5	17,5			
30	96,0	97,0	69,0	60,0	49,8	32,8	46	30,4	24,9	16,6	46	30,4	24,9	16,6	46	30,4	24,9	16,6			
34	78,0	79,0	66,0	55,5	46,5	31,2	50	28,5	23,5	15,8	50	28,5	23,5	15,8	50	28,5	23,5	15,8			
38	65,0	65,5	63,0	51,5	43,6	29,7	54	26,8	22,3	15,1	54	26,8	22,3	15,1	54	26,8	22,3	15,1			
42	54,5	55,0	56,0	48,0	41,0	28,4	58	25,4	21,2	14,5	58	25,4	21,2	14,5	58	25,4	21,2	14,5			
46	46,6	47,1	47,9	44,9	38,8	27,2	62	24,3	20,3	14,0	62	24,3	20,3	14,0	62	24,3	20,3	14,0			
50	39,7	40,2	41,0	42,2	36,9	26,1	66	23,1	19,5	13,5	66	23,1	19,5	13,5	66	23,1	19,5	13,5			
54	33,8	34,2	34,9	37,7	35,3	25,3	70	22,0	18,8	13,0	70	22,0	18,8	13,0	70	22,0	18,8	13,0			
58	28,7	29,1	29,7	32,5	33,3	24,5	74	20,9	18,0	12,6	74	20,9	18,0	12,6	74	20,9	18,0	12,6			
62	24,4	24,7	25,3	28,1	28,7	23,7	78	20,0	17,2	12,2	78	20,0	17,2	12,2	78	20,0	17,2	12,2			
66	20,7	21,0	21,5	24,2	24,8	22,9	79	19,7	16,9	12,1	79	19,7	16,9	12,1	79	19,7	16,9	12,1			
70	17,5	17,7	18,1	20,8	21,4	21,9	82	19,1	16,3	11,9	82	19,1	16,3	11,9	82	19,1	16,3	11,9			
74	14,7	14,9	15,2	17,9	18,3	19,2	86	17,3	15,2	11,6	86	17,3	15,2	11,6	86	17,3	15,2	11,6			
75	14,0	14,2	14,5	17,2	17,6	18,5	87	16,8	14,9	11,5	87	16,8	14,9	11,5	87	16,8	14,9	11,5			
78	12,2	12,4	-	15,2	15,6	16,4	88	16,3	14,7	11,5	88	16,3	14,7	11,5	88	16,3	14,7	11,5			
82	10,0	10,2	-	12,9	13,2	13,8	90	15,4	14,2	11,4	90	15,4	14,2	11,4	90	15,4	14,2	11,4			
84	9,0	9,2	-	11,8	12,1	12,7	91	14,9	13,9	11,3	91	14,9	13,9	11,3	91	14,9	13,9	11,3			
86	8,1	-	-	10,8	11,1	11,6	94	13,4	13,1	11,2	94	13,4	13,1	11,2	94	13,4	13,1	11,2			
87	-	-	-	10,3	10,6	11,1	98	11,5	11,9	11,1	98	11,5	11,9	11,1	98	11,5	11,9	11,1			
90	-	-	-	8,9	9,1	-	102	9,6	10,2	-	102	9,6	10,2	-	102	9,6	10,2	-			
94	-	-	-	7,2	7,4	-	106	7,6	8,6	-	106	7,6	8,6	-	106	7,6	8,6	-			
96	-	-	-	6,4	6,6	-	107	7,2	8,2	-	107	7,2	8,2	-	107	7,2	8,2	-			
98	-	-	-	5,6	-	-	109	6,2	-	-	109	6,2	-	-	109	6,2	-	-			

25 t 65 t 105 t 145 t 185 t 225 t

12-36 m							14 m x 14 m / 16 m x 16 m		9.8 m/s		360°		ISO			
90 m							14 m x 14 m		SH+LF_1		96m		16 m x 16 m		SH+LF_1	
12 m							24 m		12 m		15°		20°		30°	
m	t	t	t	t	t	t	m	t	t	t	m	t	t	t		
15	161,0	-	-	-	-	-	15	147,0	-	-	15	147,0	-	-		
16	160,0	130,0	-	-	-	-	16	145,0	130,0	-	16	145,0	130,0	-		
18	152,0	125,0	82,0	-	-	-	18	143,0	125,0	82,5	18	143,0	125,0	82,5		
19	148,0	122,5	80,7	80,0	-	-	20	139,0	121,0	80,0	20	139,0	121,0	80,0		
20	144,0	120,0	79,5	78,0	-	-	22	136,0	117,0	78,0	22	136,0	117,0	78,0		
21	140,5	118,0	78,5	76,0	59,0	-	24	132,0	113,0	76,0	24	132,0	113,0	76,0		
22	137,0	116,0	77,5	74,0	58,0	-	26	121,0	107,0	74,5	26	121,0	107,0	74,5		
24	131,0	112,0	75,5	70,5	55,5	-	28	110,0	102,0	73,0	28	110,0	102,0	73,0		
25	126,5	110,0	74,5	68,7	54,5	35,3	30	101,0	96,5	71,0	30	101,0	96,5	71,0		
26	122,0	108,0	73,5	67,0	53,5	34,8	34	83,5	86,0	67,0	34	83,5	86,0	67,0		
28	113,0	105,0	72,0	64,5	52,0	33,9	38	69,0	74,0	62,0	38	69,0	74,0	62,0		
30	104,0	101,0	70,0	61,5	50,0	33,0	42	57,0	62,5	57,0	42	57,0	62,5	57,0		
31	100,0	98,3	69,1	60,3	49,3	32,6	46	48,5	53,0	52,0	46	48,5	53,0	52,0		
34	88,0	90,5	66,5	57,0	47,3	31,5	50	42,3	45,6	45,6	50	42,3	45,6	45,6		
38	74,5	76,0	63,5	52,5	44,5	30,0	54	37,0	38,4	39,0	54	37,0	38,4	39,0		
42	63,0	65,0	61,0	49,4	41,9	28,7	58	30,3	31,4	32,8	58	30,3	31,4	32,8		
46	54,5	55,5	55,5	46,3	39,7	27,5	62	24,2	25,1	27,0	62	24,2	25,1	27,0		
50	47,3	47,8	47,8	43,5	37,8	26,5	66	18,6	19,3	21,7	66	18,6	19,3	21,7		
54	40,6	41,0	41,3	41,1	36,1	25,6	70	13,6	14,2	16,7	70	13,6	14,2	16,7		
58	34,8	35,2	35,9	38,9	34,2	24,9	74	9,1	9,7	12,2	74	9,1	9,7	12,2		
62	28,8	30,1	30,8	33,7	31,6	24,1	78	5,2	5,8	8,1	78	5,2	5,8	8,1		
66	23,4	24,7	26,4	29,3	29,1	23,4	80	3,5	4,1	6,3	80	3,5	4,1	6,3		
70	18,5	19,9	21,8	25,4	26,0	22,2	82	-	-	4,5	82	-	-	4,5		
74	14,1	15,5	17,0	22,1	22,6	20,1	83	-	-	3,6	83	-	-	3,6		
78	10,3	11,6	12,5	19,0	19,5	18,0										
79	9,4	10,7	11,4	18,3	18,8	17,4										
82	7,0	8,2	-	16,4	16,8	15,9										
86	4,2	5,2	-	13,4	14,0	13,7										
87	3,6	4,5	-	12,5	13,1	13,2										
88	-	3,9	-	11,7	12,3	12,7										
90	-	-	-	10,1	10,7	11,6										
91	-	-	-	9,3	9,8	11,1										
94	-	-	-	6,9	7,3	-										
98	-	-	-	3,8	4,0	-										

25 t 65 t 105 t 145 t 185 t 225 t

		12-36 m						12 m x 12 m			9.8 m/s			360°			ISO			
		48 m						12 m x 12 m									54 m			
		LH+LF_1																		
		12 m			24 m			36 m			12 m			24 m			36 m			
		15°	20°	30°	15°	20°	30°	15°	20°	30°	15°	20°	30°	15°	20°	30°	15°	20°	30°	
m	t	t	t	t	t	t	t	t	t	t	t	t	t	t	t	t	t	t	t	m
10	178,0	-	-	-	-	-	-	-	-	-	-	-	-	-	-	-	-	-	-	10
11	170,0	141,0	-	-	-	-	-	-	-	175,0	-	-	-	-	-	-	-	-	-	11
12	162,0	136,0	-	-	-	-	-	-	-	167,0	139,0	-	-	-	-	-	-	-	-	12
13	155,5	131,5	91,0	-	-	-	-	-	-	160,5	134,5	92,0	-	-	-	-	-	-	-	13
14	149,0	127,0	88,5	86,5	-	-	-	-	-	154,0	130,0	90,0	-	-	-	-	-	-	-	14
15	143,5	123,0	86,5	83,2	-	-	-	-	-	148,5	126,0	87,7	85,0	-	-	-	-	-	-	15
16	138,0	119,0	84,5	80,0	66,5	-	-	-	-	143,0	122,0	85,5	82,0	-	-	-	-	-	-	16
17	133,0	115,5	82,5	77,0	64,5	-	-	-	-	138,5	119,0	83,7	79,0	65,0	-	-	-	-	-	17
18	128,0	112,0	80,5	74,0	62,5	-	54,5	-	-	134,0	116,0	82,0	76,0	63,5	-	-	-	-	-	18
19	124,0	109,0	78,7	71,5	60,7	-	52,7	-	-	130,0	112,5	80,5	73,7	61,7	-	53,5	-	-	-	19
20	120,0	106,0	77,0	69,0	59,0	39,8	51,0	-	-	126,0	109,0	79,0	71,5	60,0	40,0	51,5	-	-	-	20
21	116,5	103,0	75,2	66,7	57,2	38,9	49,4	40,2	-	122,0	106,5	77,2	69,2	58,5	39,2	50,1	-	-	-	21
22	113,0	100,0	73,5	64,5	55,5	38,0	47,9	39,0	-	118,0	104,0	75,5	67,0	57,0	38,4	48,8	39,3	-	-	22
24	106,0	95,0	71,0	61,0	53,0	36,5	45,1	36,9	-	112,0	99,0	73,0	63,0	54,0	36,9	46,0	37,3	-	-	24
26	101,0	91,0	68,5	57,5	50,0	35,0	42,7	35,0	-	106,0	94,5	70,5	59,5	51,5	35,6	43,6	35,5	-	-	26
27	98,5	89,0	67,2	56,0	48,9	34,3	41,5	34,1	23,2	103,5	92,5	69,2	58,0	50,4	34,9	42,5	34,7	23,3	-	27
28	96,0	87,0	66,0	54,5	47,8	33,7	40,3	33,3	22,7	101,0	90,5	68,0	56,5	49,3	34,3	41,4	33,9	22,8	-	28
30	91,5	84,0	64,0	51,5	45,6	32,4	38,2	31,8	21,8	96,5	87,0	66,0	54,0	47,1	33,1	39,3	32,4	21,9	-	30
34	83,5	78,0	60,0	47,0	41,9	30,3	34,4	28,9	20,1	86,5	82,0	62,5	49,2	43,4	31,0	35,6	29,7	20,4	-	34
38	74,5	72,5	57,0	43,1	39,0	28,5	31,2	26,5	18,7	73,5	74,0	59,0	45,2	40,4	29,2	32,4	27,3	19,0	-	38
42	64,5	65,0	54,5	39,8	36,4	27,0	28,7	24,6	17,5	63,5	63,5	56,5	41,8	37,9	27,7	29,8	25,3	17,8	-	42
46	56,5	57,0	52,5	37,0	34,2	25,6	26,5	23,0	16,5	55,5	55,5	54,0	38,9	35,6	26,4	27,7	23,7	16,8	-	46
48	53,2	53,7	52,0	35,8	33,2	25,0	25,5	22,2	16,0	52,3	52,4	51,7	37,6	34,6	25,8	26,7	23,0	16,3	-	48
50	50,0	50,5	-	34,6	32,2	24,5	24,6	21,5	15,6	49,1	49,3	49,5	36,4	33,6	25,2	25,8	22,3	15,9	-	50
52	47,4	47,7	-	33,6	31,3	24,0	23,7	20,8	15,2	46,4	46,5	46,6	35,3	32,7	24,7	24,9	21,6	15,5	-	52
53	46,1	46,3	-	33,1	30,9	23,7	23,3	20,5	15,0	45,0	45,1	-	34,8	32,2	24,4	24,5	21,3	15,3	-	53
54	44,9	-	-	32,6	30,5	23,5	22,9	20,2	14,8	43,7	43,8	-	34,3	31,8	24,2	24,1	21,0	15,1	-	54
55	43,7	-	-	32,1	30,1	23,3	22,5	19,9	14,6	42,5	42,6	-	33,8	31,4	24,0	23,7	20,7	14,9	-	55
58	-	-	-	30,8	29,1	22,8	21,5	19,1	14,1	39,1	39,2	-	32,5	30,3	23,4	22,6	19,8	14,4	-	58
59	-	-	-	30,4	28,8	22,7	21,1	18,8	13,9	38,1	-	-	32,0	30,0	23,2	22,2	19,5	14,2	-	59
60	-	-	-	30,1	28,5	-	20,8	18,6	13,8	37,1	-	-	31,6	29,7	23,0	21,9	19,3	14,1	-	60
62	-	-	-	29,4	28,0	-	20,2	18,1	13,5	-	-	-	30,9	29,1	22,7	21,3	18,8	13,8	-	62
64	-	-	-	28,8	27,6	-	19,6	17,6	13,2	-	-	-	30,2	28,5	22,5	20,7	18,3	13,5	-	64
65	-	-	-	28,5	27,4	-	19,3	17,4	13,1	-	-	-	29,8	28,2	-	20,4	18,1	13,4	-	65
66	-	-	-	28,2	-	-	19,1	17,2	13,0	-	-	-	29,5	28,0	-	20,1	17,9	13,3	-	66
70	-	-	-	-	-	-	18,2	16,5	12,7	-	-	-	28,4	27,3	-	19,1	17,1	12,9	-	70
71	-	-	-	-	-	-	18,0	16,3	12,6	-	-	-	28,1	-	-	18,8	16,9	12,8	-	71
72	-	-	-	-	-	-	17,8	16,2	-	-	-	-	27,9	-	-	18,6	16,8	12,7	-	72
74	-	-	-	-	-	-	17,4	16,0	-	-	-	-	-	-	-	18,2	16,5	12,6	-	74
75	-	-	-	-	-	-	17,2	15,9	-	-	-	-	-	-	-	18,0	16,3	12,5	-	75
76	-	-	-	-	-	-	17,0	15,8	-	-	-	-	-	-	-	17,8	16,2	-	-	76
78	-	-	-	-	-	-	16,7	-	-	-	-	-	-	-	-	17,5	16,0	-	-	78
81	-	-	-	-	-	-	-	-	-	-	-	-	-	-	-	16,9	15,7	-	-	81
82	-	-	-	-	-	-	-	-	-	-	-	-	-	-	-	16,8	-	-	-	82
83	-	-	-	-	-	-	-	-	-	-	-	-	-	-	-	16,7	-	-	-	83

25t 65t 105t 145t 185t 225t

		12-36 m									12 m x 12 m									9.8 m/s			360°			ISO		
		60 m									66 m																	
		12 m x 12 m																										
		LH+LF_1																										
		12 m			24 m			36 m			12 m			24 m			36 m											
		15°			20°			30°			15°			20°			30°			15°			20°			30°		
m	t	t	t	t	t	t	t	t	t	t	t	t	t	t	t	t	t	t	t	t	t	t	t	t	t	m		
11	178,0	-	-	-	-	-	-	-	-	-	-	-	-	-	-	-	-	-	-	-	-	-	-	-	-	-	11	
12	172,0	140,0	-	-	-	-	-	-	-	-	-	-	-	-	-	-	-	-	-	-	-	-	-	-	-	-	12	
13	165,5	136,0	-	-	-	-	-	-	-	-	-	-	-	-	-	-	-	-	-	-	-	-	-	-	-	-	13	
14	159,0	132,0	90,5	-	-	-	-	-	-	-	-	-	-	-	-	-	-	-	-	-	-	-	-	-	-	-	14	
15	153,5	128,0	88,7	86,5	-	-	-	-	-	-	-	-	-	-	-	-	-	-	-	-	-	-	-	-	-	-	15	
16	148,0	124,0	87,0	83,5	-	-	-	-	-	-	-	-	-	-	-	-	-	-	-	-	-	-	-	-	-	-	16	
17	143,5	121,0	85,2	80,7	66,0	-	-	-	-	-	-	-	-	-	-	-	-	-	-	-	-	-	-	-	-	-	17	
18	139,0	118,0	83,5	78,0	64,0	-	-	-	-	-	-	-	-	-	-	-	-	-	-	-	-	-	-	-	-	-	18	
19	135,0	115,0	81,7	75,7	62,2	-	54,0	-	-	-	-	-	-	-	-	-	-	-	-	-	-	-	-	-	-	-	19	
20	131,0	112,0	80,0	73,5	60,5	-	52,0	-	-	-	-	-	-	-	-	-	-	-	-	-	-	-	-	-	-	-	20	
21	126,5	109,5	78,5	71,2	59,0	39,4	50,7	-	-	-	-	-	-	-	-	-	-	-	-	-	-	-	-	-	-	-	21	
22	122,0	107,0	77,0	69,0	57,5	38,7	49,4	39,6	-	-	-	-	-	-	-	-	-	-	-	-	-	-	-	-	-	-	22	
23	118,0	104,5	75,7	67,0	56,2	38,0	48,0	38,6	-	-	-	-	-	-	-	-	-	-	-	-	-	-	-	-	-	-	23	
24	114,0	102,0	74,5	65,0	55,0	37,3	46,7	37,7	-	-	-	-	-	-	-	-	-	-	-	-	-	-	-	-	-	-	24	
26	107,0	97,5	72,0	62,0	52,5	36,0	44,3	35,9	-	-	-	-	-	-	-	-	-	-	-	-	-	-	-	-	-	-	26	
28	100,0	93,5	69,5	58,5	50,5	34,8	42,2	34,3	22,9	-	-	-	-	-	-	-	-	-	-	-	-	-	-	-	-	-	28	
30	95,0	90,0	67,5	56,0	48,4	33,6	40,2	32,9	22,0	-	-	-	-	-	-	-	-	-	-	-	-	-	-	-	-	-	30	
34	85,5	83,5	64,0	51,0	44,7	31,6	36,6	30,3	20,6	-	-	-	-	-	-	-	-	-	-	-	-	-	-	-	-	-	34	
38	72,5	72,5	61,0	47,2	41,6	29,8	33,4	28,0	19,2	-	-	-	-	-	-	-	-	-	-	-	-	-	-	-	-	-	38	
42	62,5	62,5	58,0	43,7	39,1	28,3	30,8	26,0	18,1	-	-	-	-	-	-	-	-	-	-	-	-	-	-	-	-	-	42	
46	54,0	54,5	55,0	40,8	36,9	27,0	28,6	24,3	17,1	-	-	-	-	-	-	-	-	-	-	-	-	-	-	-	-	-	46	
50	47,8	48,0	48,4	38,2	34,9	25,8	26,9	22,9	16,2	-	-	-	-	-	-	-	-	-	-	-	-	-	-	-	-	-	50	
54	42,3	42,5	42,8	36,0	33,1	24,8	25,2	21,6	15,4	-	-	-	-	-	-	-	-	-	-	-	-	-	-	-	-	-	54	
57	38,8	39,0	39,2	34,5	31,9	24,1	24,0	20,7	14,8	-	-	-	-	-	-	-	-	-	-	-	-	-	-	-	-	-	57	
58	37,7	37,9	-	34,0	31,5	23,9	23,6	20,5	14,7	-	-	-	-	-	-	-	-	-	-	-	-	-	-	-	-	-	58	
61	34,7	34,9	-	32,8	30,4	23,4	22,6	19,7	14,2	-	-	-	-	-	-	-	-	-	-	-	-	-	-	-	-	-	61	
62	33,8	33,9	-	32,4	30,1	23,2	22,3	19,5	14,1	-	-	-	-	-	-	-	-	-	-	-	-	-	-	-	-	-	62	
63	32,9	33,0	-	32,0	29,8	23,0	22,0	19,2	13,9	-	-	-	-	-	-	-	-	-	-	-	-	-	-	-	-	-	63	
65	31,3	-	-	31,2	29,2	22,7	21,4	18,7	13,7	-	-	-	-	-	-	-	-	-	-	-	-	-	-	-	-	-	65	
66	-	-	-	30,9	29,0	22,6	21,1	18,5	13,6	-	-	-	-	-	-	-	-	-	-	-	-	-	-	-	-	-	66	
68	-	-	-	30,0	28,5	22,4	20,5	18,1	13,3	-	-	-	-	-	-	-	-	-	-	-	-	-	-	-	-	-	68	
70	-	-	-	29,1	28,0	-	20,0	17,7	13,1	-	-	-	-	-	-	-	-	-	-	-	-	-	-	-	-	-	70	
71	-	-	-	28,4	27,6	-	19,7	17,5	13,0	-	-	-	-	-	-	-	-	-	-	-	-	-	-	-	-	-	71	
72	-	-	-	27,8	27,3	-	19,5	17,3	12,9	-	-	-	-	-	-	-	-	-	-	-	-	-	-	-	-	-	72	
74	-	-	-	26,5	26,6	-	19,1	17,0	12,8	-	-	-	-	-	-	-	-	-	-	-	-	-	-	-	-	-	74	
75	-	-	-	25,8	26,0	-	18,9	16,8	12,7	-	-	-	-	-	-	-	-	-	-	-	-	-	-	-	-	-	75	
77	-	-	-	24,5	-	-	18,5	16,5	12,5	-	-	-	-	-	-	-	-	-	-	-	-	-	-	-	-	-	77	
78	-	-	-	-	-	-	18,3	16,4	12,5	-	-	-	-	-	-	-	-	-	-	-	-	-	-	-	-	-	78	
80	-	-	-	-	-	-	17,9	16,2	12,4	-	-	-	-	-	-	-	-	-	-	-	-	-	-	-	-	-	80	
82	-	-	-	-	-	-	17,5	16,0	-	-	-	-	-	-	-	-	-	-	-	-	-	-	-	-	-	-	82	
84	-	-	-	-	-	-	17,2	15,8	-	-	-	-	-	-	-	-	-	-	-	-	-	-	-	-	-	-	84	
86	-	-	-	-	-	-	16,9	15,6	-	-	-	-	-	-	-	-	-	-	-	-	-	-	-	-	-	-	86	
87	-	-	-	-	-	-	16,8	15,5	-	-	-	-	-	-	-	-	-	-	-	-	-	-	-	-	-	-	87	
88	-	-	-	-	-	-	16,7	-	-	-	-	-	-	-	-	-	-	-	-	-	-	-	-	-	-	-	88	
90	-	-	-	-	-	-	-	-	-	-	-	-	-	-	-	-	-	-	-	-	-	-	-	-	-	-	90	
92	-	-	-	-	-	-	-	-	-	-	-	-	-	-	-	-	-	-	-	-	-	-	-	-	-	-	92	
94	-	-	-	-	-	-	-	-	-	-	-	-	-	-	-	-	-	-	-	-	-	-	-	-	-	-	94	

25 t 65 t 105 t 145 t 185 t 225 t

12-36 m				12 m x 12 m				9.8 m/s				360°		ISO	
72 m												75 m			
12 m x 12 m															
LH+LF_1				LH+LF_3				LH+LF_1				LH+LF_3			
12 m				24 m				36 m				12 m			
15°		20°		30°		15°		20°		30°		15°		20°	
m	t	t	t	t	t	t	t	t	t	t	t	t	t	t	m
12	166,0	-	-	159,0	-	-	-	-	-	-	-	-	158,0	-	12
13	161,0	140,0	-	154,5	130,0	-	-	-	-	-	-	-	155,0	-	13
14	156,0	136,0	-	150,0	127,0	-	-	-	-	-	-	-	152,0	127,0	14
15	151,0	133,0	90,0	145,5	123,5	-	-	-	-	-	-	-	147,5	124,0	15
16	146,0	130,0	88,5	141,0	120,0	86,5	-	-	-	-	-	-	143,0	121,0	16
18	136,0	124,0	85,0	133,0	114,0	81,5	65,0	-	-	-	-	-	134,0	115,0	18
20	127,0	118,0	82,0	125,0	109,0	77,0	62,0	-	52,5	-	-	-	127,0	110,0	20
22	119,0	112,0	79,5	119,0	104,0	72,5	59,0	39,0	50,0	-	-	-	121,0	106,0	22
23	115,5	109,0	78,2	116,0	102,0	70,7	57,7	38,3	48,8	38,9	-	-	118,0	103,5	23
24	112,0	106,0	77,0	113,0	100,0	69,0	56,5	37,7	47,7	38,0	-	-	115,0	101,0	24
26	105,0	100,0	74,5	108,0	96,0	65,5	54,5	36,5	45,4	36,4	-	-	109,0	97,5	26
28	98,5	95,5	72,5	103,0	92,0	62,5	52,5	35,5	43,4	35,0	-	-	105,0	93,5	28
29	95,7	93,0	71,5	100,7	90,2	61,0	51,5	34,9	42,5	34,3	22,5	-	102,5	91,7	29
30	93,0	90,5	70,5	98,5	88,5	59,5	50,5	34,4	41,6	33,6	22,2	-	100,0	90,0	30
34	83,0	81,5	67,0	83,5	82,5	55,0	46,9	32,5	38,2	31,2	20,8	-	83,0	83,5	34
38	70,5	70,5	63,5	70,0	70,5	50,5	43,8	30,8	35,2	29,0	19,6	-	69,5	70,0	38
42	60,0	60,5	60,5	60,0	60,5	47,3	41,2	29,3	32,6	27,1	18,5	-	59,5	60,0	42
46	52,0	52,5	53,0	52,0	52,0	44,2	39,0	28,1	30,3	25,4	17,5	-	51,0	51,5	46
50	45,5	45,8	46,3	45,4	45,7	41,5	37,1	26,9	28,4	23,9	16,7	-	44,7	45,0	50
54	40,0	40,2	40,6	39,9	40,1	39,2	35,4	25,9	26,8	22,7	15,9	-	39,1	39,4	54
58	35,3	35,5	35,9	35,2	35,4	37,1	33,8	25,0	25,5	21,6	15,3	-	34,4	34,7	58
62	31,2	31,4	31,8	31,1	31,3	33,6	32,3	24,2	24,2	20,6	14,6	-	30,2	30,4	62
65	28,5	28,7	28,9	28,3	28,5	30,9	30,8	23,6	23,2	19,9	14,2	-	27,4	27,6	65
66	27,6	27,8	-	27,4	27,6	30,1	30,4	23,5	22,9	19,7	14,1	-	26,5	26,7	66
70	24,5	24,6	-	24,3	24,4	26,8	27,1	22,9	21,8	18,8	13,6	-	23,4	23,5	70
74	21,7	21,8	-	21,5	21,6	23,9	24,2	22,4	20,7	18,0	13,2	-	20,6	20,7	74
76	20,5	-	-	20,3	-	22,6	22,9	22,2	20,2	17,7	13,0	-	19,4	19,4	76
77	-	-	-	-	-	21,9	22,2	22,1	20,0	17,5	12,9	-	18,8	-	77
78	-	-	-	-	-	21,3	21,6	-	19,8	17,4	12,8	-	18,2	-	78
82	-	-	-	-	-	19,0	19,2	-	19,0	16,8	12,5	-	-	-	82
85	-	-	-	-	-	17,4	17,6	-	18,4	16,4	12,3	-	-	-	85
86	-	-	-	-	-	16,9	-	-	18,3	16,3	12,3	-	-	-	86
87	-	-	-	-	-	16,5	-	-	17,9	16,2	12,2	-	-	-	87
89	-	-	-	-	-	-	-	-	16,9	16,0	12,1	-	-	-	89
90	-	-	-	-	-	-	-	-	16,5	15,9	-	-	-	-	90
94	-	-	-	-	-	-	-	-	14,7	14,9	-	-	-	-	94
97	-	-	-	-	-	-	-	-	13,5	13,7	-	-	-	-	97
98	-	-	-	-	-	-	-	-	13,1	-	-	-	-	-	98
99	-	-	-	-	-	-	-	-	12,7	-	-	-	-	-	99





25t
65t
105t
145t
185t
225t

12-36 m 12 m x 12 m 9.8 m/s 360° ISO															
78 m 81 m															
12 m x 12 m															
LH+LF_1				LH+LF_3				LH+LF_1				LH+LF_3			
12 m				24 m				36 m				12 m			
15°		20°		30°		15°		20°		30°		15°		20°	
m	t	t	t	t	t	t	t	t	t	t	t	t	t	t	m
13	150,0	-	-	158,0	-	-	-	-	-	-	-	-	160,0	-	13
14	145,0	129,0	-	153,0	136,0	-	-	-	-	-	-	-	155,0	141,0	14
16	137,0	122,0	88,5	144,0	130,0	-	-	-	-	-	-	-	146,0	135,0	16
17	133,0	119,0	87,0	140,0	127,5	83,5	-	-	-	-	-	-	142,0	132,0	17
18	129,0	116,0	85,5	136,0	125,0	81,5	-	-	-	-	-	-	138,0	129,0	18
19	125,5	113,0	84,2	132,5	122,5	79,5	63,5	-	-	-	-	-	134,0	126,0	19
20	122,0	110,0	83,0	129,0	120,0	77,5	62,0	-	-	-	-	-	130,0	123,0	20
21	118,5	107,5	81,7	125,5	118,0	75,7	60,7	-	51,5	-	-	-	127,0	120,5	21
22	115,0	105,0	80,5	122,0	116,0	74,0	59,5	39,1	50,0	-	-	-	124,0	118,0	22
24	109,0	100,0	78,0	116,0	111,0	70,5	57,0	37,9	48,0	38,2	-	-	117,0	112,0	24
26	103,0	95,5	76,0	111,0	107,0	67,0	55,0	36,8	45,8	36,6	-	-	110,0	107,0	26
28	97,5	91,0	73,5	106,0	102,0	64,0	53,0	35,7	43,8	35,2	-	-	103,0	101,0	28
29	95,0	89,0	72,5	102,7	100,0	62,7	52,0	35,2	42,9	34,5	22,5	-	100,2	98,7	29
30	92,5	87,0	71,5	99,5	98,0	61,5	51,0	34,7	42,1	33,9	22,2	-	97,5	96,5	30
34	82,0	79,0	68,0	83,5	84,0	56,5	47,8	32,9	38,8	31,6	20,9	-	82,5	83,0	34
38	69,0	69,5	65,0	70,0	70,5	52,5	44,8	31,2	35,9	29,5	19,7	-	69,5	70,0	38
42	59,0	59,0	60,0	60,0	60,5	48,8	42,1	29,8	33,3	27,6	18,7	-	59,0	59,5	42
46	50,5	51,0	51,5	52,0	52,0	45,6	39,8	28,5	31,0	25,9	17,7	-	51,0	51,0	46
50	44,1	44,5	45,0	45,3	45,6	43,1	38,0	27,4	29,1	24,4	16,9	-	44,3	44,7	50
54	38,6	38,9	39,3	39,8	40,0	40,6	36,5	26,4	27,4	23,1	16,1	-	38,8	39,1	54
58	33,8	34,1	34,5	35,1	35,3	36,5	34,9	25,5	26,1	22,1	15,5	-	34,0	34,3	58
62	29,5	29,8	30,2	31,0	31,2	32,4	32,8	24,6	24,9	21,1	14,9	-	29,7	30,0	62
66	25,9	26,1	26,4	27,3	27,5	28,6	29,1	23,9	23,7	20,2	14,3	-	26,1	26,3	66
70	22,7	22,9	23,1	24,1	24,3	25,3	25,7	23,3	22,6	19,3	13,8	-	22,9	23,0	70
74	19,9	20,0	-	21,4	21,5	22,4	22,7	22,7	21,5	18,5	13,4	-	20,1	20,2	74
78	17,5	17,6	-	18,9	19,0	19,8	20,1	20,6	20,6	17,8	13,0	-	17,6	17,8	78
79	16,9	17,0	-	18,3	18,5	19,2	19,4	19,9	20,2	17,6	12,9	-	17,0	17,2	79
81	15,8	-	-	17,3	-	18,0	18,2	18,7	19,4	17,3	12,7	-	16,0	16,1	81
82	-	-	-	-	-	17,4	17,7	18,1	19,1	17,2	12,7	-	15,5	-	82
83	-	-	-	-	-	16,9	17,1	-	18,6	17,0	12,6	-	15,0	-	83
86	-	-	-	-	-	15,4	15,6	-	17,0	16,7	12,4	-	-	-	86
90	-	-	-	-	-	13,5	13,7	-	15,0	15,4	12,2	-	-	-	90
92	-	-	-	-	-	12,6	-	-	14,1	14,5	12,1	-	-	-	92
93	-	-	-	-	-	-	-	-	13,7	14,0	12,1	-	-	-	93
94	-	-	-	-	-	-	-	-	13,3	13,6	-	-	-	-	94
98	-	-	-	-	-	-	-	-	11,6	11,9	-	-	-	-	98
102	-	-	-	-	-	-	-	-	10,2	10,4	-	-	-	-	102
104	-	-	-	-	-	-	-	-	9,5	-	-	-	-	-	104

25t
 65t
 105t
 145t
 185t
 225t

12-36 m														12 m x 12 m				9.8 m/s			360°		ISO	
84 m														12 m x 12 m				87 m						
LH+LF_1				LH+LF_3				LH+LF_1				LH+LF_3												
12 m				24 m				36 m				12 m												
15°		20°		30°		15°		20°		30°		15°		20°		30°		15°		20°				
m	t	t	t	t	t	t	t	t	t	t	t	t	t	t	t	t	t	t	t	m				
13	141,0	-	-	157,0	-	-	-	-	-	-	-	-	-	-	-	-	-	-	-	13				
14	139,0	129,0	-	155,0	140,0	-	-	-	-	-	-	-	-	-	-	150,0	-	-	-	14				
15	137,0	127,5	-	151,0	137,5	-	-	-	-	-	-	-	-	-	-	146,5	138,0	-	-	15				
16	135,0	126,0	89,0	147,0	135,0	-	-	-	-	-	-	-	-	-	-	143,0	135,0	-	-	16				
17	131,5	123,5	87,7	143,0	132,0	83,0	-	-	-	-	-	-	-	-	-	139,0	132,5	-	-	17				
18	128,0	121,0	86,5	139,0	129,0	82,0	-	-	-	-	-	-	-	-	-	135,0	130,0	-	-	18				
19	124,5	119,0	85,2	135,0	126,5	80,7	63,5	-	-	-	-	-	-	-	-	131,5	127,0	-	-	19				
20	121,0	117,0	84,0	131,0	124,0	79,5	62,5	-	-	-	-	-	-	-	-	128,0	124,0	-	-	20				
21	117,0	114,0	82,7	127,0	120,5	77,5	61,2	-	-	51,5	-	-	-	-	-	124,0	120,5	-	-	21				
22	113,0	111,0	81,5	123,0	117,0	75,5	60,0	-	-	50,0	-	-	-	-	-	120,0	117,0	-	-	22				
23	110,0	107,5	80,5	119,5	114,0	73,7	58,7	38,6	-	49,1	-	-	-	-	-	116,5	114,0	-	-	23				
24	107,0	104,0	79,5	116,0	111,0	72,0	57,5	38,0	48,2	38,1	-	-	-	-	-	113,0	111,0	-	-	24				
26	100,0	98,5	77,0	109,0	106,0	69,0	55,5	36,9	46,1	36,7	-	-	-	-	-	107,0	104,0	-	-	26				
28	94,5	92,5	75,0	103,0	100,0	66,0	54,0	35,9	44,2	35,3	-	-	-	-	-	100,0	98,5	-	-	28				
30	89,0	87,5	73,0	97,0	95,5	63,0	52,0	35,0	42,5	34,1	22,1	-	-	-	-	95,0	92,5	-	-	30				
34	79,0	77,5	68,5	82,0	83,0	58,0	48,9	33,2	39,5	31,9	20,9	-	-	-	-	81,5	82,0	-	-	34				
38	68,5	69,0	64,5	69,0	69,5	54,0	45,9	31,7	36,7	29,9	19,8	-	-	-	-	68,0	68,5	-	-	38				
42	58,5	59,0	59,5	58,5	59,0	50,5	43,2	30,2	34,2	28,1	18,8	-	-	-	-	57,5	58,0	-	-	42				
46	50,0	50,5	51,5	50,5	51,0	47,3	40,9	29,0	31,9	26,4	17,9	-	-	-	-	49,7	50,0	-	-	46				
50	43,7	44,0	44,6	44,0	44,3	44,5	39,0	27,9	30,0	25,0	17,1	-	-	-	-	43,0	43,3	-	-	50				
54	38,1	38,4	38,9	38,4	38,7	40,9	37,3	26,9	28,3	23,7	16,3	-	-	-	-	37,4	37,7	-	-	54				
58	33,2	33,5	34,1	33,6	33,9	36,1	35,6	26,0	26,8	22,6	15,7	-	-	-	-	32,3	32,6	-	-	58				
62	29,0	29,2	29,7	29,3	29,6	31,9	32,4	25,2	25,7	21,7	15,1	-	-	-	-	28,0	28,3	-	-	62				
66	25,3	25,5	25,9	25,6	25,8	28,1	28,6	24,4	24,6	20,8	14,6	-	-	-	-	24,3	24,6	-	-	66				
70	22,1	22,3	22,6	22,4	22,6	24,7	25,2	23,6	23,4	20,0	14,1	-	-	-	-	21,1	21,3	-	-	70				
74	19,3	19,5	19,7	19,6	19,8	21,8	22,2	22,9	22,3	19,2	13,6	-	-	-	-	18,3	18,5	-	-	74				
78	16,8	17,0	-	17,2	17,3	19,2	19,5	20,1	21,0	18,4	13,2	-	-	-	-	15,8	16,0	-	-	78				
82	14,7	14,8	-	15,0	15,1	16,9	17,2	17,7	18,6	17,6	12,9	-	-	-	-	13,6	13,8	-	-	82				
83	14,2	14,3	-	14,5	14,6	16,3	16,6	17,1	18,0	17,5	12,8	-	-	-	-	13,1	13,3	-	-	83				
84	13,7	-	-	14,0	14,1	15,8	16,1	16,6	17,5	17,3	12,7	-	-	-	-	12,6	12,8	-	-	84				
86	12,4	-	-	13,1	-	14,8	15,0	15,5	16,4	16,9	12,6	-	-	-	-	11,7	11,8	-	-	86				
89	-	-	-	-	-	13,3	13,5	-	14,9	15,4	12,3	-	-	-	-	10,4	-	-	-	89				
90	-	-	-	-	-	12,9	13,1	-	14,5	14,9	12,3	-	-	-	-	-	-	-	-	90				
94	-	-	-	-	-	11,2	11,4	-	12,7	13,1	12,1	-	-	-	-	-	-	-	-	94				
95	-	-	-	-	-	10,8	11,0	-	12,3	12,6	12,0	-	-	-	-	-	-	-	-	95				
98	-	-	-	-	-	9,7	-	-	11,1	11,4	11,9	-	-	-	-	-	-	-	-	98				
102	-	-	-	-	-	-	-	-	9,6	9,9	-	-	-	-	-	-	-	-	-	102				
106	-	-	-	-	-	-	-	-	8,2	8,5	-	-	-	-	-	-	-	-	-	106				
107	-	-	-	-	-	-	-	-	7,9	8,1	-	-	-	-	-	-	-	-	-	107				
109	-	-	-	-	-	-	-	-	7,3	-	-	-	-	-	-	-	-	-	-	109				

25t 65t 105t 145t 185t 225t

  12-36 m  12 m x 12 m  9.8 m/s 360° ISO															
90 m															
12 m x 12 m															
LH+LF_1				LH+LF_3				LH+LF_1				LH+LF_3			
12 m				24 m				36 m				12 m			
15°		20°		30°		15°		20°		30°		15°		20°	
m	t	t	t	t	t	t	t	t	t	t	t	t	t	t	m
14	130,0	-	-	139,0	-	-	-	-	-	-	-	134,0	-	-	14
15	128,0	117,0	-	136,5	131,0	-	-	-	-	-	-	132,0	127,0	-	15
16	126,0	116,0	-	134,0	129,0	-	-	-	-	-	-	130,0	126,0	-	16
17	123,5	114,0	88,0	131,5	127,0	-	-	-	-	-	-	127,5	123,5	-	17
18	121,0	112,0	86,5	129,0	125,0	77,0	-	-	-	-	-	125,0	121,0	-	18
20	115,0	109,0	84,0	123,0	121,0	75,0	62,5	-	-	-	-	119,0	117,0	-	20
22	109,0	106,0	82,0	117,0	115,0	72,5	60,0	-	-	-	-	113,0	112,0	-	22
23	106,0	103,0	81,0	113,5	112,0	71,5	59,0	38,5	-	-	-	110,0	109,0	-	23
24	103,0	100,0	80,0	110,0	109,0	70,5	58,0	38,0	-	-	-	107,0	106,0	-	24
26	97,5	95,5	78,0	105,0	103,0	68,5	56,0	37,0	-	-	-	102,0	100,0	-	26
28	92,0	90,5	76,0	99,5	98,0	66,5	54,0	36,0	-	-	-	96,5	95,5	-	28
30	86,5	86,0	73,5	94,0	92,5	64,5	52,5	35,1	-	-	-	91,5	90,5	-	30
34	77,0	77,0	68,5	81,5	82,0	59,5	49,4	33,5	-	-	-	80,5	81,0	-	34
38	67,5	68,0	63,0	68,0	68,5	55,5	46,6	31,9	-	-	-	67,5	68,0	-	38
42	57,0	57,5	58,0	58,0	58,5	52,0	44,0	30,6	-	-	-	57,0	57,5	-	42
46	49,1	49,5	50,0	49,9	50,0	48,8	41,7	29,3	-	-	-	48,9	49,3	-	46
50	42,4	42,7	43,4	43,2	43,5	45,5	39,7	28,2	-	-	-	42,2	42,5	-	50
54	36,6	37,0	37,7	37,6	37,9	39,8	38,0	27,3	-	-	-	36,4	36,8	-	54
58	31,6	31,9	32,5	32,6	32,9	34,9	35,5	26,5	-	-	-	31,3	31,7	-	58
62	27,3	27,6	28,1	28,3	28,6	30,5	31,1	25,7	-	-	-	27,0	27,3	-	62
66	23,6	23,9	24,3	24,6	24,8	26,6	27,2	24,9	-	-	-	23,3	23,6	-	66
70	20,4	20,6	21,0	21,4	21,6	23,3	23,7	23,9	-	-	-	20,1	20,3	-	70
74	17,6	17,8	18,1	18,5	18,7	20,3	20,7	21,5	-	-	-	17,2	17,5	-	74
78	15,1	15,2	15,5	16,1	16,2	17,7	18,1	18,7	-	-	-	14,7	14,9	-	78
79	14,5	14,6	14,9	15,5	15,6	17,1	17,5	18,1	-	-	-	14,2	14,3	-	79
82	12,9	13,0	-	13,9	14,0	15,3	15,7	16,3	-	-	-	12,5	12,7	-	82
86	10,9	11,0	-	11,9	12,0	13,2	13,5	14,0	-	-	-	10,6	10,7	-	86
89	9,6	9,7	-	10,6	10,7	11,7	12,0	12,5	-	-	-	9,2	9,3	-	89
90	9,2	-	-	10,2	-	11,3	11,6	12,0	-	-	-	8,8	8,9	-	90
91	8,8	-	-	9,8	-	10,8	11,1	11,6	-	-	-	8,4	8,5	-	91
94	-	-	-	-	-	9,6	9,9	-	-	-	-	7,3	-	-	94
98	-	-	-	-	-	8,1	8,3	-	-	-	-	-	-	-	98
100	-	-	-	-	-	7,3	7,5	-	-	-	-	-	-	-	100
102	-	-	-	-	-	6,7	-	-	-	-	-	-	-	-	102
103	-	-	-	-	-	6,4	-	-	-	-	-	-	-	-	103





-  25t
-  65t
-  105t
-  145t
-  185t
-  225t

12-36 m						12 m x 12 m / 14 m x 14 m						9.8 m/s						360°		ISO	
96 m						96 m						99 m									
12 m x 12 m						14 m x 14 m															
LH+LF_1			LH+LF_3			LH+LF_1			LH+LF_3			LH+LF_1			LH+LF_3						
12 m						24 m						36 m						12 m			
15°		20°		30°		15°		20°		30°		15°		20°		30°		15°		20°	
m	t	t	t	t	t	m	t	t	t	t	t	t	t	t	t	t	t	t	t	t	
14	115,0	-	-	-	128,0	15	-	-	-	-	-	-	-	-	-	-	120,0	-	-	-	
15	113,5	106,0	-	-	126,0	16	-	-	-	-	-	-	-	-	-	-	118,0	117,0	-	-	
16	112,0	104,0	-	-	124,0	18	69,5	-	-	-	-	-	-	-	-	-	114,0	113,0	-	-	
17	110,5	103,0	86,0	-	121,5	20	67,5	58,5	-	-	-	-	-	-	-	-	110,0	109,0	-	-	
18	109,0	102,0	84,5	-	119,0	22	65,5	57,0	-	-	-	-	-	-	-	-	105,0	105,0	-	-	
20	106,0	99,0	82,5	-	115,0	23	64,5	56,2	-	-	45,5	-	-	-	-	-	102,5	102,5	-	-	
22	103,0	96,0	80,5	-	110,0	24	63,5	55,5	37,9	44,9	-	-	-	-	-	-	100,0	100,0	-	-	
24	98,0	92,5	78,5	-	104,0	25	62,5	54,7	37,4	44,3	37,1	-	-	-	-	-	97,7	97,5	-	-	
26	93,0	88,5	76,5	-	99,0	26	61,5	54,0	36,9	43,7	36,4	-	-	-	-	-	95,5	95,0	-	-	
28	88,0	85,0	74,5	-	94,0	28	59,5	52,5	36,0	42,5	35,2	-	-	-	-	-	91,0	90,5	-	-	
30	83,5	81,0	72,5	-	89,0	30	58,0	51,0	35,2	41,3	34,1	-	-	-	-	-	86,5	85,5	-	-	
34	75,0	74,0	67,5	-	80,0	31	57,0	50,3	34,8	40,7	33,5	21,7	-	-	-	-	84,3	83,3	-	-	
38	66,5	67,0	62,0	-	67,0	34	54,0	48,4	33,6	38,9	32,0	20,8	-	-	-	-	78,0	77,0	-	-	
42	56,5	57,0	57,0	-	56,5	38	51,0	45,8	32,1	36,7	30,2	19,8	-	-	-	-	70,0	69,5	-	-	
46	48,2	48,7	49,5	-	48,6	42	47,7	43,4	30,8	34,5	28,5	18,9	-	-	-	-	63,0	62,5	-	-	
50	41,5	41,9	42,6	-	41,8	46	44,7	41,1	29,6	32,6	27,0	18,1	-	-	-	-	56,5	56,5	-	-	
54	35,6	36,0	36,7	-	36,0	50	41,8	39,0	28,5	30,7	25,6	17,3	-	-	-	-	49,6	49,9	-	-	
58	30,5	30,9	31,5	-	30,9	54	39,2	37,2	27,5	29,1	24,3	16,6	-	-	-	-	43,1	43,4	-	-	
62	26,2	26,5	27,1	-	26,6	58	36,7	35,5	26,7	27,5	23,2	15,9	-	-	-	-	37,3	37,7	-	-	
66	22,5	22,8	23,3	-	22,9	62	34,1	33,0	26,0	26,1	22,2	15,4	-	-	-	-	32,3	32,7	-	-	
70	19,3	19,5	20,0	-	19,7	66	31,4	30,4	25,2	24,9	21,4	14,9	-	-	-	-	28,1	28,4	-	-	
74	16,4	16,7	17,0	-	16,8	70	28,3	28,0	24,5	23,6	20,7	14,4	-	-	-	-	24,4	24,6	-	-	
78	13,9	14,1	14,4	-	14,3	74	24,9	25,4	23,3	22,3	20,0	14,0	-	-	-	-	21,1	21,3	-	-	
82	11,7	11,9	12,2	-	12,1	78	21,9	22,4	21,8	21,0	19,2	13,6	-	-	-	-	18,2	18,4	-	-	
83	11,2	11,4	11,6	-	11,6	82	19,3	19,7	20,3	19,7	18,5	13,1	-	-	-	-	15,7	15,9	-	-	
86	9,8	9,9	-	-	10,1	86	16,9	17,2	17,8	18,3	17,8	12,7	-	-	-	-	13,4	13,6	-	-	
90	8,0	8,1	-	-	8,4	90	14,7	15,0	15,6	16,6	16,7	12,3	-	-	-	-	11,4	11,5	-	-	
94	6,4	6,5	-	-	6,8	94	12,8	13,1	13,5	14,6	15,0	11,9	-	-	-	-	9,6	9,7	-	-	
96	5,7	-	-	-	6,1	95	12,3	12,6	13,0	14,1	14,5	11,8	-	-	-	-	9,2	9,3	-	-	
						97	11,4	11,7	-	13,1	13,5	11,6	-	-	-	-	8,4	8,5	-	-	
						98	11,0	11,3	-	12,7	13,1	11,5	-	-	-	-	8,0	-	-	-	
						99	10,6	10,8	-	12,2	12,7	11,4	-	-	-	-	7,6	-	-	-	
						102	9,4	9,6	-	11,0	11,4	11,2	-	-	-	-	-	-	-	-	
						106	8,0	8,1	-	9,5	9,8	10,4	-	-	-	-	-	-	-	-	
						107	7,6	-	-	9,1	9,4	10,0	-	-	-	-	-	-	-	-	
						108	7,3	-	-	8,8	9,1	-	-	-	-	-	-	-	-	-	
						110	-	-	-	8,1	8,4	-	-	-	-	-	-	-	-	-	
						114	-	-	-	6,8	7,0	-	-	-	-	-	-	-	-	-	
						117	-	-	-	5,8	6,0	-	-	-	-	-	-	-	-	-	
						118	-	-	-	5,5	-	-	-	-	-	-	-	-	-	-	
						120	-	-	-	5,0	-	-	-	-	-	-	-	-	-	-	

25t 65t 105t 145t 185t 225t

12-36 m						14 m x 14 m / 16 m x 16 m						9.8 m/s			360°			ISO			
102 m						102 m						105 m									
14 m x 14 m						16 m x 16 m															
LH+LF_1			LH+LF_3			LH+LF_1			LH+LF_3												
12 m						24 m			36 m			12 m									
15°		20°		30°		15°		20°		30°		15°		20°		30°		15°		20°	
m	t	t	t	t	t	m	t	t	t	t	t	t	t	t	t	t	t	t	t	t	
15	106,0	-	-	-	117,0	15	-	-	-	-	-	-	-	-	-	112,0	-	-	-	-	
16	104,0	97,0	-	-	116,0	16	-	-	-	-	-	-	-	-	-	111,0	107,0	-	-	-	
18	102,0	94,0	79,0	-	112,0	18	-	-	-	-	-	-	-	-	-	107,0	105,0	-	-	-	
20	98,5	91,5	77,0	-	108,0	20	64,0	-	-	-	-	-	-	-	-	105,5	103,0	-	-	-	
22	95,5	88,5	74,5	-	104,0	22	63,0	-	-	-	-	-	-	-	-	104,0	101,0	-	-	-	
24	92,0	86,0	72,5	-	100,0	24	62,2	54,0	-	-	-	-	-	-	-	102,0	99,7	-	-	-	
26	87,5	83,0	70,5	-	95,0	26	61,5	53,5	-	-	-	-	-	-	-	100,0	98,5	-	-	-	
28	83,0	80,0	69,0	-	90,5	28	60,5	52,7	-	-	42,6	-	-	-	-	98,2	96,5	-	-	-	
30	79,0	77,0	67,0	-	86,0	30	59,5	52,0	37,8	-	42,0	-	-	-	-	96,5	94,5	-	-	-	
34	71,0	71,0	62,5	-	77,5	34	57,5	50,5	36,9	-	40,8	35,0	-	-	-	92,0	90,0	-	-	-	
38	64,0	65,0	58,0	-	69,5	38	55,5	49,2	36,0	-	39,7	34,2	-	-	-	87,5	85,5	-	-	-	
42	57,5	59,0	53,5	-	62,5	42	53,5	47,7	35,2	-	38,5	33,3	-	-	-	83,5	81,5	-	-	-	
46	51,5	53,0	49,5	-	55,5	46	52,6	47,0	34,8	-	37,9	32,8	21,6	-	-	81,5	79,5	-	-	-	
50	46,2	47,0	45,1	-	49,0	50	50,0	45,0	33,7	-	36,2	31,6	20,8	-	-	75,5	73,5	-	-	-	
54	41,6	41,5	41,0	-	42,4	54	47,1	42,4	32,3	-	34,0	29,9	19,8	-	-	67,5	66,5	-	-	-	
58	36,6	36,9	36,9	-	36,6	58	44,1	40,0	31,0	-	31,9	28,4	18,9	-	-	60,5	59,5	-	-	-	
62	31,6	31,9	32,6	-	31,6	62	41,2	37,8	29,8	-	30,0	26,9	18,1	-	-	54,0	53,5	-	-	-	
66	27,3	27,6	28,2	-	27,3	66	38,6	35,7	28,7	-	28,2	25,4	17,4	-	-	47,9	47,9	-	-	-	
70	23,6	23,9	24,4	-	23,6	70	36,2	33,8	27,8	-	26,5	24,1	16,7	-	-	41,4	41,4	-	-	-	
74	20,3	20,6	21,0	-	20,4	74	34,0	32,2	26,9	-	25,0	22,9	16,0	-	-	35,9	35,9	-	-	-	
78	17,5	17,7	18,1	-	17,5	78	32,0	30,5	25,9	-	23,7	21,8	15,5	-	-	31,0	31,0	-	-	-	
82	14,9	15,1	15,4	-	14,9	82	29,4	28,2	25,0	-	22,4	20,7	14,9	-	-	27,6	27,6	-	-	-	
86	12,6	12,8	13,1	-	12,7	86	26,8	26,0	24,0	-	21,3	19,8	14,5	-	-	23,9	23,9	-	-	-	
88	11,6	11,8	12,0	-	11,6	88	24,2	23,9	23,1	-	20,1	18,9	14,1	-	-	20,5	20,5	-	-	-	
90	10,6	10,8	-	-	10,6	90	21,7	21,8	21,4	-	18,9	18,0	13,7	-	-	17,6	17,6	-	-	-	
94	8,1	8,5	-	-	8,8	94	19,0	19,0	19,0	-	17,6	17,1	13,3	-	-	14,9	14,9	-	-	-	
98	5,4	6,0	-	-	7,2	98	16,5	16,5	16,5	-	16,4	16,2	12,8	-	-	12,5	12,5	-	-	-	
99	4,7	5,3	-	-	6,8	99	14,2	14,2	14,2	-	15,2	15,3	12,1	-	-	10,3	10,3	-	-	-	
100	4,1	-	-	-	6,4	100	12,1	12,1	12,1	-	13,9	14,0	11,3	-	-	8,4	8,4	-	-	-	
102	-	-	-	-	5,7	102	10,2	10,2	10,2	-	12,2	12,2	10,5	-	-	6,6	6,6	-	-	-	
						100	9,2	9,2	9,3	-	11,2	11,2	10,1	-	-	5,8	5,8	-	-	-	
						102	8,2	8,4	-	-	10,3	10,3	9,7	-	-	5,0	5,0	-	-	-	
						104	7,2	7,6	-	-	9,4	9,5	9,1	-	-	4,3	-	-	-	-	
						106	6,2	6,8	-	-	8,6	8,6	8,6	-	-	-	-	-	-	-	
						110	4,2	5,3	-	-	7,1	7,1	7,1	-	-	-	-	-	-	-	
						111	3,8	5,0	-	-	6,7	6,7	6,7	-	-	-	-	-	-	-	
						114	-	-	-	-	5,6	5,6	-	-	-	-	-	-	-	-	
						118	-	-	-	-	4,3	4,3	-	-	-	-	-	-	-	-	
						120	-	-	-	-	3,6	3,6	-	-	-	-	-	-	-	-	

25t 65t 105t 145t 185t 225t

  12-36 m  16 m x 16 m  9.8 m/s 360° ISO															
108 m 111 m 114 m															
16 m x 16 m															
LH+LF_1 LH+LF_3 LH+LF_1 LH+LF_3 LH+LF_1															
12 m 24 m 12 m															
15° 20° 30° 15° 20° 15° 20° 30° 15° 20° 15° 20° 30°															
m	t	t	t	t	t	t	t	t	t	t	t	t	t	t	m
15	99,0	-	-	107,0	-	-	-	-	-	-	-	-	-	-	15
16	97,5	91,0	-	106,0	103,0	-	-	-	-	101,0	-	91,0	-	-	16
17	96,5	89,5	-	104,5	102,0	-	-	-	-	100,0	98,0	89,5	86,0	-	17
18	95,5	88,5	74,0	103,0	101,0	-	-	-	-	99,0	97,0	88,5	85,0	-	18
19	94,0	87,0	73,0	101,5	99,7	60,5	-	-	-	97,5	95,7	87,5	84,0	71,0	19
20	92,5	85,5	72,0	100,0	98,5	59,5	-	-	-	96,0	94,5	86,5	83,0	70,5	20
21	91,2	84,2	71,0	98,5	97,2	58,5	51,0	-	-	94,5	93,5	85,0	82,0	69,7	21
22	90,0	83,0	70,0	97,0	96,0	57,5	50,0	-	-	93,0	92,5	83,5	81,0	69,0	22
24	87,5	80,5	68,0	93,5	93,0	55,5	48,9	-	-	90,0	89,5	81,0	79,0	67,5	24
25	85,7	79,2	67,2	91,5	90,7	54,7	48,2	37,1	-	88,0	87,5	79,5	78,0	66,5	25
26	84,0	78,0	66,5	89,5	88,5	54,0	47,5	36,6	-	86,0	85,5	78,0	77,0	65,5	26
28	80,0	75,5	64,5	85,0	84,5	52,0	46,1	35,8	-	82,5	82,0	74,5	74,0	64,5	28
30	76,0	72,5	63,0	81,5	80,5	50,0	44,7	35,0	-	78,5	78,0	71,0	70,5	63,0	30
34	68,5	67,5	59,0	73,5	73,0	47,2	42,1	33,5	-	71,5	71,0	64,0	64,0	60,0	34
38	61,5	62,0	55,0	66,5	66,0	44,1	39,6	32,2	-	64,5	64,0	57,5	57,5	56,0	38
42	55,0	56,5	51,0	59,5	59,0	41,3	37,4	30,9	-	57,5	57,5	51,5	52,5	51,0	42
46	49,4	51,0	47,0	53,0	53,0	38,5	35,3	29,7	-	51,5	51,0	46,2	47,2	45,9	46
50	44,2	45,5	42,9	46,9	46,9	36,0	33,4	28,6	-	45,5	45,5	40,7	42,2	40,8	50
54	39,5	40,0	39,1	40,4	40,4	33,7	31,6	27,6	-	39,2	39,2	35,3	37,4	35,6	54
58	35,0	35,0	35,0	34,8	34,8	31,5	30,1	26,6	-	33,7	33,7	30,0	32,4	30,3	58
62	30,2	30,2	30,2	30,0	30,0	29,4	28,7	25,5	-	28,9	28,9	24,8	26,9	25,3	62
66	26,8	26,8	26,8	26,6	26,6	27,5	26,9	24,0	-	25,5	25,5	19,6	21,4	20,5	66
70	23,0	23,0	23,0	22,8	22,8	25,0	24,6	22,6	-	21,7	21,7	14,6	15,8	15,9	70
74	19,7	19,7	19,7	19,5	19,5	22,6	22,4	21,1	-	18,3	18,3	9,7	10,3	11,5	74
78	16,7	16,7	16,7	16,5	16,5	20,0	20,0	19,6	-	15,4	15,4	4,8	4,8	7,3	78
79	16,0	16,0	16,0	15,8	15,8	19,3	19,3	19,0	-	14,7	14,7	3,6	-	6,3	79
81	14,6	14,6	14,6	14,4	14,4	17,9	17,9	17,8	-	13,3	13,3	-	-	4,4	81
82	14,0	14,0	14,0	13,8	13,8	17,2	17,2	17,2	-	12,7	12,7	-	-	-	82
86	11,6	11,3	10,6	11,5	11,5	14,7	14,7	14,7	-	10,3	10,3	-	-	-	86
90	8,4	7,8	7,0	9,3	9,3	12,3	12,2	12,4	-	8,2	8,2	-	-	-	90
92	6,7	6,0	5,2	8,3	8,3	10,7	10,6	11,3	-	7,2	7,2	-	-	-	92
94	5,0	4,3	-	7,3	7,3	9,1	9,1	10,3	-	6,2	6,2	-	-	-	94
95	4,1	-	-	6,8	6,8	8,3	8,4	9,8	-	5,7	5,7	-	-	-	95
98	-	-	-	5,5	5,5	5,9	6,0	8,4	-	4,4	4,4	-	-	-	98
100	-	-	-	4,7	4,7	4,3	4,4	7,5	-	3,6	3,6	-	-	-	100
101	-	-	-	4,3	4,3	-	3,7	7,1	-	-	-	-	-	-	101
102	-	-	-	3,9	3,9	-	-	6,7	-	-	-	-	-	-	102
103	-	-	-	3,5	3,5	-	-	6,3	-	-	-	-	-	-	103
104	-	-	-	-	-	-	-	5,9	-	-	-	-	-	-	104

25t
65t
105t
145t
185t
225t

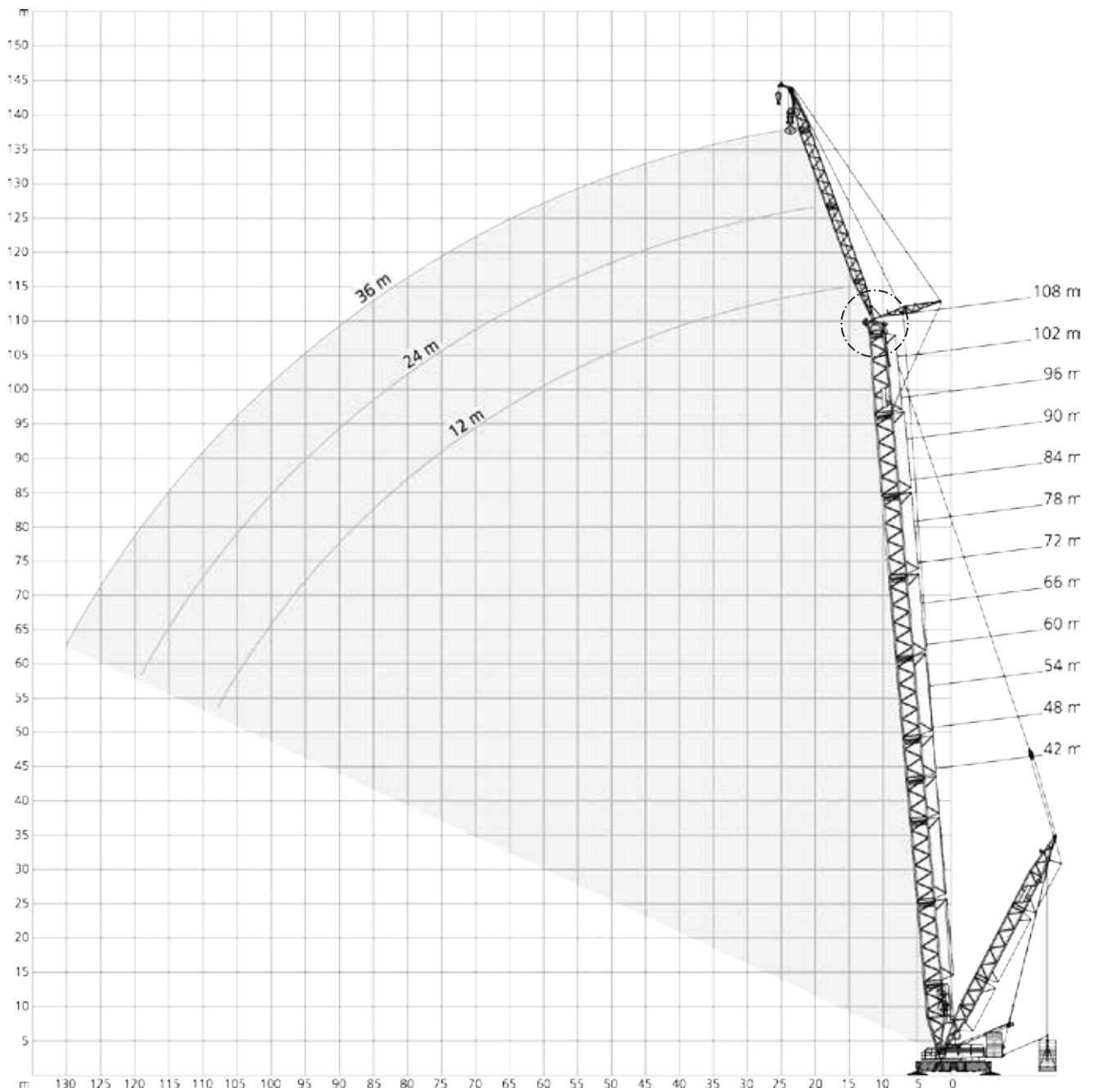
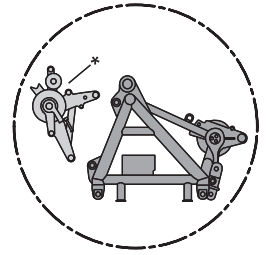

* Attachable · Anbaubar · Amovible · Montabile · Acoplable · Adaptável · Приставн

225 t		12 m x 12 m						9.8 m/s			360°			ISO	
		42 m													
		SSL+LF_1													
		12 m				24 m				36 m					
		0t-325t		0t-325t		0t-325t		0t-325t		0t-325t		0t-325t		0t-325t	
		15°		20°		30°		15°		20°		30°		15°	
m	t	t	t	t	t	t	t	t	t	t	t	t	t	t	t
11	162,0	162,0	-	-	-	-	-	-	-	-	-	-	-	-	-
12	154,0	154,0	120,0	120,0	-	-	-	-	-	-	-	-	-	-	-
13	147,0	147,0	115,5	115,5	76,5	76,5	-	-	-	-	-	-	-	-	-
14	140,0	140,0	111,0	111,0	74,5	74,5	-	-	-	-	-	-	-	-	-
15	134,0	134,0	107,0	107,0	72,5	72,5	79,0	79,0	-	-	-	-	-	-	-
16	128,0	128,0	103,0	103,0	70,5	70,5	75,5	75,5	-	-	-	-	-	-	-
17	123,5	123,5	99,7	99,7	68,7	68,7	72,5	72,5	58,0	58,0	-	-	-	-	-
18	119,0	119,0	96,5	96,5	67,0	67,0	69,5	69,5	56,0	56,0	-	-	-	-	-
19	114,5	114,5	93,7	93,7	65,5	65,5	67,0	67,0	54,2	54,2	-	-	51,0	51,0	-
20	110,0	110,0	91,0	91,0	64,0	64,0	64,5	64,5	52,5	52,5	35,9	35,9	49,1	49,3	-
22	103,0	103,0	86,0	86,0	61,5	61,5	60,0	60,0	49,3	49,3	34,1	34,1	45,6	45,7	37,0
24	97,0	97,0	81,5	81,5	59,0	59,0	56,0	56,0	46,5	46,5	32,5	32,5	42,5	42,6	34,7
26	91,5	91,5	77,5	77,5	56,5	56,5	53,0	53,0	44,0	44,0	31,1	31,1	39,9	39,9	32,7
27	89,0	89,0	75,5	75,5	55,5	55,5	51,4	51,4	42,9	42,9	30,4	30,4	38,7	38,7	31,8
28	86,5	86,5	73,5	73,5	54,5	54,5	49,9	49,9	41,8	41,8	29,8	29,8	37,5	37,5	30,9
30	82,5	82,5	70,5	70,5	53,0	53,0	47,2	47,2	39,8	39,8	28,6	28,6	35,3	35,3	29,3
34	75,1	75,1	65,1	65,1	50,0	50,0	42,8	42,8	36,4	36,4	26,6	26,6	31,7	31,7	26,5
38	69,0	69,0	60,6	60,6	47,6	47,6	38,9	38,9	33,5	33,5	24,9	24,9	28,6	28,6	24,1
42	64,0	64,0	57,0	57,0	45,6	45,6	35,7	35,7	31,0	31,0	23,4	23,4	26,0	26,0	22,1
44	62,1	62,1	55,6	55,6	44,8	44,8	34,4	34,4	30,0	30,0	22,8	22,8	24,9	24,9	21,3
46	60,3	60,3	54,3	54,3	-	-	33,1	33,1	29,0	29,0	22,2	22,2	23,9	23,9	20,5
48	58,5	58,5	53,0	53,0	-	-	31,9	31,9	28,1	28,1	21,7	21,7	22,9	22,9	19,7
50	55,0	57,0	-	-	-	-	30,9	30,9	27,3	27,3	21,2	21,2	22,1	22,1	19,0
54	-	-	-	-	-	-	29,0	29,0	25,8	25,8	20,4	20,4	20,5	20,5	17,8
55	-	-	-	-	-	-	28,6	28,6	25,5	25,5	20,3	20,3	20,1	20,1	17,5
58	-	-	-	-	-	-	27,5	27,5	24,7	24,7	-	-	19,1	19,1	16,7
60	-	-	-	-	-	-	26,8	26,8	24,2	24,2	-	-	18,5	18,5	16,2
62	-	-	-	-	-	-	26,3	26,3	-	-	-	-	18,0	18,0	15,8
66	-	-	-	-	-	-	-	-	-	-	-	-	17,0	17,0	15,0
67	-	-	-	-	-	-	-	-	-	-	-	-	16,8	16,8	14,8
70	-	-	-	-	-	-	-	-	-	-	-	-	16,2	16,2	14,4
72	-	-	-	-	-	-	-	-	-	-	-	-	15,8	15,8	14,1
73	-	-	-	-	-	-	-	-	-	-	-	-	15,6	15,6	-



225 t		12 m x 12 m				9.8 m/s				360°				ISO			
		48 m															
		SSL+LF_1															
		12 m				24 m				36 m							
		0t-325t		0t-325t		0t-325t		0t-325t		0t-325t		0t-325t		0t-325t		0t-325t	
		15°		20°		30°		15°		20°		30°		15°		20°	
m	t	t	t	t	t	t	t	t	t	t	t	t	t	t	t	t	t
11	167,0	167,0	-	-	-	-	-	-	-	-	-	-	-	-	-	-	-
12	159,0	159,0	122,0	122,0	-	-	-	-	-	-	-	-	-	-	-	-	-
14	145,0	145,0	114,0	114,0	75,5	75,5	-	-	-	-	-	-	-	-	-	-	-
15	139,5	139,5	110,0	110,0	73,7	73,7	81,0	81,0	-	-	-	-	-	-	-	-	-
16	134,0	134,0	106,0	106,0	72,0	72,0	78,0	78,0	-	-	-	-	-	-	-	-	-
17	129,0	129,0	103,0	103,0	70,2	70,2	75,0	75,0	59,0	59,0	-	-	-	-	-	-	-
18	124,0	124,0	100,0	100,0	68,5	68,5	72,0	72,0	57,0	57,0	-	-	-	-	-	-	-
19	120,0	120,0	97,2	97,2	67,0	67,0	69,5	69,5	55,2	55,2	-	-	51,5	51,5	-	-	-
20	116,0	116,0	94,5	94,5	65,5	65,5	67,0	67,0	53,5	53,5	-	-	49,8	50,0	-	-	-
21	112,5	112,5	92,0	92,0	64,2	64,2	64,7	64,7	52,0	52,0	35,4	35,4	48,1	48,3	-	-	-
22	109,0	109,0	89,5	89,5	63,0	63,0	62,5	62,5	50,5	50,5	34,6	34,6	46,5	46,7	37,5	37,5	-
24	102,0	102,0	85,0	85,0	60,5	60,5	58,5	58,5	48,0	48,0	33,1	33,1	43,6	43,8	35,3	35,4	-
26	97,0	97,0	81,0	81,0	58,5	58,5	55,0	55,0	45,5	45,5	31,7	31,7	40,9	41,1	33,4	33,4	-
28	92,0	92,0	77,5	77,5	56,5	56,5	52,0	52,0	43,3	43,3	30,5	30,5	38,6	38,8	31,7	31,7	21,3
30	87,5	87,5	74,0	74,0	54,5	54,5	49,6	49,6	41,3	41,3	29,3	29,3	36,6	36,6	30,1	30,1	20,4
34	80,1	80,1	68,6	68,6	51,5	51,5	45,1	45,1	37,9	37,9	27,3	27,3	33,0	33,0	27,4	27,4	18,9
38	73,8	73,8	64,0	64,0	49,0	49,0	41,2	41,2	35,0	35,0	25,6	25,6	29,9	29,9	25,0	25,0	17,6
42	68,5	68,5	60,0	60,0	47,0	47,0	37,8	37,8	32,5	32,5	24,1	24,1	27,3	27,3	23,0	23,0	16,4
46	60,5	64,1	57,0	57,0	45,4	45,4	35,1	35,1	30,4	30,4	22,9	22,9	25,1	25,1	21,4	21,4	15,4
48	56,5	62,0	55,5	55,5	44,7	44,7	33,8	33,8	29,4	29,4	22,4	22,4	24,1	24,1	20,6	20,6	14,9
50	53,4	60,5	52,8	54,3	-	-	32,7	32,7	28,6	28,6	21,9	21,9	23,2	23,2	19,9	19,9	14,4
53	48,7	58,2	48,8	52,5	-	-	31,2	31,2	27,4	27,4	21,2	21,2	22,0	22,0	18,9	18,9	13,8
54	47,2	57,5	-	-	-	-	30,7	30,7	27,1	27,1	21,0	21,0	21,6	21,6	18,6	18,6	13,6
55	45,8	57,0	-	-	-	-	30,3	30,3	26,8	26,8	20,8	20,8	21,2	21,2	18,3	18,3	13,4
58	-	-	-	-	-	-	29,1	29,1	25,9	25,9	20,3	20,3	20,2	20,2	17,5	17,5	13,0
59	-	-	-	-	-	-	28,7	28,7	25,6	25,6	20,2	20,2	19,9	19,9	17,2	17,2	12,8
62	-	-	-	-	-	-	27,7	27,7	24,8	24,8	-	-	19,0	19,0	16,5	16,5	12,4
65	-	-	-	-	-	-	26,8	26,8	24,1	24,1	-	-	18,1	18,1	15,9	15,9	12,0
66	-	-	-	-	-	-	26,5	26,5	-	-	-	-	17,9	17,9	15,7	15,7	11,9
67	-	-	-	-	-	-	26,3	26,3	-	-	-	-	17,6	17,6	15,5	15,5	11,8
70	-	-	-	-	-	-	-	-	-	-	-	-	17,0	17,0	15,0	15,0	11,5
71	-	-	-	-	-	-	-	-	-	-	-	-	16,8	16,8	14,8	14,8	11,4
74	-	-	-	-	-	-	-	-	-	-	-	-	16,2	16,2	14,4	14,4	-
76	-	-	-	-	-	-	-	-	-	-	-	-	15,9	15,9	14,2	14,2	-
78	-	-	-	-	-	-	-	-	-	-	-	-	15,6	15,6	-	-	-



225 t		12 m x 12 m						9.8 m/s		360°			ISO		
		54 m													
		SSL+LF_1													
		12 m				24 m				36 m					
		0 t-325t		0 t-325t		0 t-325t		0 t-325t		0 t-325t		0 t-325t		0 t-325t	
		15°		20°		30°		15°		20°		30°		15°	
m	t	t	t	t	t	t	t	t	t	t	t	t	t	t	t
12	163,0	163,0	-	-	-	-	-	-	-	-	-	-	-	-	-
13	156,5	156,5	120,0	120,0	-	-	-	-	-	-	-	-	-	-	-
14	150,0	150,0	117,0	117,0	76,5	76,5	-	-	-	-	-	-	-	-	-
16	139,0	139,0	109,0	109,0	73,0	73,0	79,5	79,5	-	-	-	-	-	-	-
18	130,0	130,0	103,0	103,0	70,0	70,0	74,0	74,0	58,0	58,0	-	-	-	-	-
20	121,0	121,0	98,0	98,0	67,0	67,0	69,0	69,0	54,5	54,5	-	-	50,5	50,5	-
21	117,5	117,5	95,5	95,5	65,7	65,7	66,7	66,7	53,0	53,0	35,7	35,7	48,9	49,0	-
22	114,0	114,0	93,0	93,0	64,5	64,5	64,5	64,5	51,5	51,5	34,9	34,9	47,4	47,5	-
23	111,0	111,0	90,7	90,7	63,2	63,2	62,5	62,5	50,4	50,4	34,2	34,2	45,9	46,0	36,6
24	108,0	108,0	88,5	88,5	62,0	62,0	60,5	60,5	49,3	49,3	33,5	33,5	44,5	44,6	35,7
26	102,0	102,0	84,5	84,5	60,0	60,0	57,5	57,5	46,9	46,9	32,2	32,2	41,9	42,1	33,9
28	97,0	97,0	81,0	81,0	58,0	58,0	54,5	54,5	44,7	44,7	31,0	31,0	39,6	39,8	32,2
30	92,5	92,5	77,5	77,5	56,5	56,5	51,5	51,5	42,7	42,7	29,9	29,9	37,6	37,8	30,7
34	84,8	84,8	72,1	72,1	53,5	53,5	47,1	47,1	39,3	39,3	28,0	28,0	34,2	34,3	28,1
38	76,5	78,1	67,3	67,3	50,8	50,8	43,1	43,1	36,4	36,4	26,3	26,3	31,2	31,2	25,8
42	67,5	72,5	63,0	63,0	48,5	48,5	39,7	39,7	33,8	33,8	24,8	24,8	28,5	28,5	23,8
46	59,1	68,1	57,6	59,6	46,7	46,7	37,0	37,0	31,8	31,8	23,6	23,6	26,3	26,3	22,2
50	51,8	64,3	51,9	56,8	45,3	45,3	34,6	34,6	29,9	29,9	22,5	22,5	24,4	24,4	20,7
52	48,7	62,6	48,8	55,6	44,7	44,7	33,5	33,5	29,1	29,1	22,0	22,0	23,5	23,5	20,0
54	45,6	61,0	45,8	54,5	-	-	32,4	32,4	28,3	28,3	21,6	21,6	22,7	22,7	19,4
58	40,5	58,3	40,5	52,5	-	-	30,6	30,6	26,9	26,9	20,8	20,8	21,3	21,3	18,2
60	38,0	57,0	-	-	-	-	29,8	29,8	26,3	26,3	20,5	20,5	20,6	20,6	17,7
62	-	-	-	-	-	-	29,1	29,1	25,8	25,8	20,2	20,2	20,0	20,0	17,2
64	-	-	-	-	-	-	28,4	28,4	25,3	25,3	20,0	20,0	19,4	19,4	16,8
66	-	-	-	-	-	-	27,8	27,8	24,8	24,8	-	-	18,9	18,9	16,4
70	-	-	-	-	-	-	26,7	26,7	24,1	24,1	-	-	17,9	17,9	15,6
72	-	-	-	-	-	-	26,2	26,2	-	-	-	-	17,4	17,4	15,3
74	-	-	-	-	-	-	-	-	-	-	-	-	17,0	17,0	15,0
75	-	-	-	-	-	-	-	-	-	-	-	-	16,8	16,8	14,8
78	-	-	-	-	-	-	-	-	-	-	-	-	16,3	16,3	14,4
81	-	-	-	-	-	-	-	-	-	-	-	-	15,8	15,8	14,1
82	-	-	-	-	-	-	-	-	-	-	-	-	15,7	15,7	-
84	-	-	-	-	-	-	-	-	-	-	-	-	15,4	15,4	-

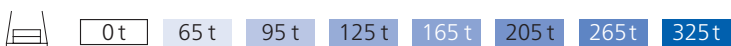

225 t		12 m x 12 m						9.8 m/s			360°			ISO			
60 m																	
SSL+LF_1																	
12 m						24 m						36 m					
0t-325t		0t-325t		0t-325t		0t-325t		0t-325t		0t-325t		0t-325t		0t-325t		0t-325t	
15°		20°		30°		15°		20°		30°		15°		20°		30°	
m	t	t	t	t	t	t	t	t	t	t	t	t	t	t	t	t	t
12	167,0	167,0	-	-	-	-	-	-	-	-	-	-	-	-	-	-	-
13	161,0	161,0	123,0	123,0	-	-	-	-	-	-	-	-	-	-	-	-	-
14	155,0	155,0	119,0	119,0	-	-	-	-	-	-	-	-	-	-	-	-	-
15	149,5	149,5	115,5	115,5	75,5	75,5	-	-	-	-	-	-	-	-	-	-	-
16	144,0	144,0	112,0	112,0	73,5	73,5	81,0	81,0	-	-	-	-	-	-	-	-	-
18	134,0	134,0	106,0	106,0	71,0	71,0	75,5	75,5	59,0	59,0	-	-	-	-	-	-	-
20	126,0	126,0	100,0	100,0	68,0	68,0	70,5	70,5	55,5	55,5	-	-	50,5	51,0	-	-	-
22	119,0	119,0	96,0	96,0	65,5	65,5	66,5	66,5	53,0	53,0	35,2	35,2	47,9	48,2	-	-	-
23	115,5	115,5	93,7	93,7	64,5	64,5	64,5	64,5	51,5	51,5	34,5	34,5	46,5	46,8	36,9	37,0	-
24	112,0	112,0	91,5	91,5	63,5	63,5	62,5	62,5	50,0	50,0	33,8	33,8	45,2	45,4	36,0	36,1	-
26	107,0	107,0	87,5	87,5	61,5	61,5	59,5	59,5	48,0	48,0	32,6	32,6	42,7	42,9	34,3	34,4	-
28	101,0	101,0	84,0	84,0	59,5	59,5	56,5	56,5	45,9	45,9	31,5	31,5	40,5	40,7	32,7	32,8	-
29	99,0	99,0	82,2	82,2	58,5	58,5	55,0	55,0	44,9	44,9	30,9	30,9	39,5	39,7	31,9	32,0	21,0
30	97,0	97,0	80,5	80,5	57,5	57,5	53,5	53,5	44,0	44,0	30,4	30,4	38,5	38,7	31,2	31,3	20,6
34	86,3	89,3	75,1	75,1	54,5	54,5	49,1	49,1	40,6	40,6	28,5	28,5	35,3	35,3	28,8	28,8	19,2
38	75,8	82,5	70,3	70,3	51,9	51,9	45,1	45,1	37,7	37,7	26,8	26,8	32,3	32,3	26,6	26,6	18,0
42	65,5	76,5	66,0	66,0	49,9	49,9	41,6	41,6	35,1	35,1	25,4	25,4	29,6	29,6	24,6	24,6	16,9
46	57,1	71,8	57,6	62,3	48,0	48,0	38,8	38,8	33,0	33,0	24,2	24,2	27,4	27,4	22,9	22,9	15,9
50	49,8	67,6	50,2	59,1	46,1	46,4	36,2	36,2	31,1	31,1	23,1	23,1	25,5	25,5	21,4	21,4	15,1
54	43,5	64,0	43,8	56,5	44,2	45,1	34,0	34,0	29,4	29,4	22,2	22,2	23,7	23,7	20,1	20,1	14,3
56	41,0	62,5	41,2	55,5	41,4	44,5	33,1	33,1	28,7	28,7	21,8	21,8	23,0	23,0	19,5	19,5	14,0
58	38,5	61,0	38,7	54,5	-	-	32,2	32,2	28,0	28,0	21,4	21,4	22,3	22,3	18,9	18,9	13,7
62	33,9	58,5	34,0	52,8	-	-	30,5	30,5	26,8	26,8	20,7	20,7	21,0	21,0	17,9	17,9	13,1
63	32,9	58,0	32,9	52,5	-	-	30,2	30,2	26,5	26,5	20,6	20,6	20,7	20,7	17,7	17,7	13,0
66	29,8	56,5	-	-	-	-	29,1	29,1	25,7	25,7	20,2	20,2	19,8	19,8	17,0	17,0	12,6
68	-	-	-	-	-	-	28,5	28,5	25,2	25,2	19,9	19,9	19,3	19,3	16,6	16,6	12,3
70	-	-	-	-	-	-	27,9	27,9	24,8	24,8	-	-	18,8	18,8	16,2	16,2	12,1
74	-	-	-	-	-	-	25,9	26,8	24,1	24,1	-	-	17,9	17,9	15,6	15,6	11,7
75	-	-	-	-	-	-	25,3	26,6	24,0	24,0	-	-	17,7	17,7	15,4	15,4	11,6
77	-	-	-	-	-	-	24,0	26,2	-	-	-	-	17,3	17,3	15,1	15,1	11,4
78	-	-	-	-	-	-	-	-	-	-	-	-	17,1	17,1	15,0	15,0	11,4
80	-	-	-	-	-	-	-	-	-	-	-	-	16,7	16,7	14,7	14,7	11,3
82	-	-	-	-	-	-	-	-	-	-	-	-	16,4	16,4	14,4	14,4	-
86	-	-	-	-	-	-	-	-	-	-	-	-	15,8	15,8	14,0	14,0	-
89	-	-	-	-	-	-	-	-	-	-	-	-	15,4	15,4	-	-	-



225 t		12 m x 12 m						9.8 m/s			360°			ISO		
		66 m														
		SSL+LF_1														
		12 m				24 m				36 m						
		0t-325t		0t-325t		0t-325t		0t-325t		0t-325t		0t-325t		0t-325t		
		15°		20°		30°		15°		20°		30°		15°		
m	t	t	t	t	t	t	t	t	t	t	t	t	t	t	t	
13	164,0	164,0	-	-	-	-	-	-	-	-	-	-	-	-	-	
14	158,0	158,0	121,0	121,0	-	-	-	-	-	-	-	-	-	-	-	
16	148,0	148,0	114,0	114,0	74,5	74,5	-	-	-	-	-	-	-	-	-	
17	143,5	143,5	111,0	111,0	73,0	73,0	79,5	79,5	-	-	-	-	-	-	-	
18	139,0	139,0	108,0	108,0	71,5	71,5	77,0	77,0	-	-	-	-	-	-	-	
19	134,5	134,5	105,5	105,5	70,2	70,2	74,7	74,7	58,0	58,0	-	-	-	-	-	
20	130,0	130,0	103,0	103,0	69,0	69,0	72,5	72,5	56,5	56,5	-	-	-	-	-	
21	126,5	126,5	100,7	100,7	68,0	68,0	70,2	70,2	55,0	55,0	-	-	49,7	50,0	-	
22	123,0	123,0	98,5	98,5	67,0	67,0	68,0	68,0	53,5	53,5	-	-	48,4	48,6	-	
23	120,0	120,0	96,2	96,2	65,7	65,7	66,2	66,2	52,2	52,2	34,8	34,8	47,1	47,3	-	
24	117,0	117,0	94,0	94,0	64,5	64,5	64,5	64,5	51,0	51,0	34,1	34,1	45,8	46,0	36,2	
26	111,0	111,0	90,5	90,5	62,5	62,5	61,0	61,0	49,1	49,1	33,0	33,0	43,4	43,6	34,5	
28	106,0	106,0	86,5	86,5	60,5	60,5	58,0	58,0	47,0	47,0	31,9	31,9	41,2	41,4	33,0	
30	101,0	101,0	83,5	83,5	59,0	59,0	55,5	55,5	45,1	45,1	30,8	30,8	39,2	39,4	31,6	
34	86,6	93,3	77,8	77,8	56,0	56,0	50,9	50,9	41,8	41,8	29,0	29,0	36,0	36,2	29,2	
38	74,0	86,5	71,1	72,8	53,3	53,3	46,9	46,9	38,9	38,9	27,4	27,4	33,2	33,3	27,1	
42	63,0	80,5	63,5	68,5	51,0	51,0	43,3	43,3	36,3	36,3	26,0	26,0	30,7	30,7	25,3	
46	55,6	75,5	56,1	64,8	49,2	49,2	40,4	40,4	34,1	34,1	24,8	24,8	28,5	28,5	23,6	
50	48,8	71,0	49,2	61,6	46,6	47,5	37,8	37,8	32,2	32,2	23,7	23,7	26,5	26,5	22,1	
54	42,4	67,0	42,8	59,0	43,3	46,1	35,6	35,6	30,5	30,5	22,7	22,7	24,7	24,7	20,8	
58	37,3	64,0	37,6	56,6	38,0	44,9	33,6	33,6	29,1	29,1	21,9	21,9	23,2	23,2	19,6	
61	33,7	61,9	34,0	55,0	34,3	44,2	32,3	32,3	28,1	28,1	21,3	21,3	22,2	22,2	18,8	
62	32,7	61,3	33,0	54,6	-	-	31,9	31,9	27,8	27,8	21,2	21,2	21,9	21,9	18,6	
66	28,7	59,0	28,9	53,0	-	-	30,4	30,4	26,6	26,6	20,6	20,6	20,7	20,7	17,7	
68	26,9	58,0	27,0	52,0	-	-	29,1	29,7	26,1	26,1	20,3	20,3	20,1	20,1	17,3	
70	25,2	57,0	-	-	-	-	27,9	29,1	25,6	25,6	20,1	20,1	19,6	19,6	16,9	
71	24,4	56,5	-	-	-	-	27,3	28,8	25,4	25,4	20,0	20,0	19,3	19,3	16,7	
72	-	-	-	-	-	-	26,7	28,5	25,2	25,2	19,9	19,9	19,1	19,1	16,5	
74	-	-	-	-	-	-	25,2	28,0	24,3	24,8	-	-	18,6	18,6	16,1	
78	-	-	-	-	-	-	22,3	27,0	22,5	24,2	-	-	17,8	17,8	15,5	
80	-	-	-	-	-	-	21,0	26,6	21,2	23,9	-	-	17,4	17,4	15,2	
82	-	-	-	-	-	-	19,7	26,2	-	-	-	-	17,0	17,0	14,9	
84	-	-	-	-	-	-	-	-	-	-	-	-	16,7	16,7	14,7	
86	-	-	-	-	-	-	-	-	-	-	-	-	16,4	16,4	14,5	
90	-	-	-	-	-	-	-	-	-	-	-	-	15,8	15,8	14,1	
91	-	-	-	-	-	-	-	-	-	-	-	-	15,6	15,7	14,0	
94	-	-	-	-	-	-	-	-	-	-	-	-	15,2	15,4	-	



225 t		12 m x 12 m						9.8 m/s			360°			ISO					
		72 m																	
		SSL+LF_1																	
		12 m				24 m				36 m									
		0t-325t		0t-325t		0t-325t		0t-325t		0t-325t		0t-325t		0t-325t		0t-325t			
		15°		20°		30°		15°		20°		30°		15°		20°		30°	
m	t	t	t	t	t	t	t	t	t	t	t	t	t	t	t	t	t	t	t
13	167,0	167,0	-	-	-	-	-	-	-	-	-	-	-	-	-	-	-	-	-
14	162,0	162,0	122,0	122,0	-	-	-	-	-	-	-	-	-	-	-	-	-	-	-
16	151,0	151,0	116,0	116,0	75,0	75,0	-	-	-	-	-	-	-	-	-	-	-	-	-
17	146,5	146,5	113,0	113,0	73,7	73,7	81,0	81,0	-	-	-	-	-	-	-	-	-	-	-
18	142,0	142,0	110,0	110,0	72,5	72,5	78,5	78,5	-	-	-	-	-	-	-	-	-	-	-
19	138,0	138,0	107,5	107,5	71,2	71,2	76,2	76,2	58,5	58,5	-	-	-	-	-	-	-	-	-
20	134,0	134,0	105,0	105,0	70,0	70,0	74,0	74,0	57,0	57,0	-	-	-	-	-	-	-	-	-
21	130,5	130,5	103,0	103,0	68,7	68,7	72,0	72,0	55,7	55,7	-	-	50,0	50,5	-	-	-	-	-
22	127,0	127,0	101,0	101,0	67,5	67,5	70,0	70,0	54,5	54,5	-	-	48,8	49,1	-	-	-	-	-
23	124,0	124,0	98,7	98,7	66,5	66,5	68,0	68,0	53,2	53,2	35,0	35,0	47,5	47,8	-	-	-	-	-
24	121,0	121,0	96,5	96,5	65,5	65,5	66,0	66,0	52,0	52,0	34,4	34,4	46,3	46,6	36,4	36,5	-	-	-
26	115,0	115,0	93,0	93,0	63,5	63,5	63,0	63,0	50,0	50,0	33,3	33,3	44,0	44,3	34,8	35,0	-	-	-
28	110,0	110,0	89,0	89,0	62,0	62,0	60,0	60,0	48,0	48,0	32,2	32,2	41,9	42,1	33,4	33,5	-	-	-
30	101,0	105,0	86,0	86,0	60,0	60,0	57,0	57,0	46,1	46,1	31,2	31,2	39,9	40,2	32,0	32,1	20,7	20,7	-
34	85,6	97,0	80,3	80,3	57,0	57,0	52,3	52,3	42,9	42,9	29,4	29,4	36,7	37,0	29,6	29,8	19,4	19,5	-
38	72,3	90,0	72,1	75,3	54,3	54,3	48,3	48,3	40,0	40,0	27,9	27,9	34,0	34,2	27,6	27,7	18,3	18,3	-
42	61,0	84,0	61,5	71,0	52,0	52,0	45,0	45,0	37,4	37,4	26,5	26,5	31,6	31,7	25,8	25,9	17,3	17,3	-
46	53,6	79,0	54,1	67,3	50,2	50,2	42,0	42,0	35,2	35,2	25,3	25,3	29,4	29,5	24,2	24,3	16,4	16,4	-
50	46,8	74,5	47,2	64,0	46,7	48,6	39,4	39,4	33,3	33,3	24,2	24,2	27,4	27,5	22,8	22,8	15,6	15,6	-
54	40,4	70,5	40,8	61,0	41,4	47,1	37,1	37,1	31,6	31,6	23,2	23,2	25,6	25,7	21,4	21,4	14,8	14,9	-
58	35,3	67,1	35,6	58,6	36,1	45,8	35,1	35,1	30,1	30,1	22,4	22,4	24,1	24,1	20,2	20,2	14,2	14,2	-
62	30,7	64,1	31,0	56,5	31,3	44,7	32,7	33,3	28,7	28,7	21,6	21,6	22,7	22,7	19,2	19,2	13,6	13,6	-
65	27,6	62,1	27,8	55,0	28,1	44,1	30,7	32,1	27,8	27,8	21,1	21,1	21,8	21,8	18,5	18,5	13,2	13,2	-
66	26,6	61,5	26,8	54,5	-	-	30,1	31,7	27,5	27,5	21,0	21,0	21,5	21,5	18,3	18,3	13,1	13,1	-
70	23,2	59,1	23,4	53,1	-	-	26,5	30,3	26,0	26,5	20,4	20,4	20,4	20,4	17,4	17,4	12,6	12,6	-
73	20,7	57,6	20,9	52,0	-	-	24,0	29,3	24,5	25,8	20,1	20,1	19,6	19,6	16,8	16,8	12,3	12,3	-
74	20,0	57,2	-	-	-	-	23,3	29,0	23,7	25,6	20,0	20,0	19,4	19,4	16,6	16,6	12,2	12,2	-
76	18,6	56,5	-	-	-	-	21,8	28,5	22,2	25,2	19,8	19,8	18,9	18,9	16,3	16,3	12,0	12,0	-
77	-	-	-	-	-	-	21,1	28,2	21,4	25,0	19,7	19,7	18,7	18,7	16,1	16,1	11,9	11,9	-
78	-	-	-	-	-	-	20,4	28,0	20,7	24,8	-	-	18,5	18,5	16,0	16,0	11,9	11,9	-
82	-	-	-	-	-	-	17,8	27,0	18,1	24,2	-	-	17,7	17,7	15,4	15,4	11,5	11,5	-
85	-	-	-	-	-	-	16,0	26,4	16,2	23,8	-	-	17,0	17,2	14,9	14,9	11,3	11,3	-
86	-	-	-	-	-	-	15,4	26,3	-	-	-	-	16,7	17,0	14,8	14,8	11,3	11,3	-
88	-	-	-	-	-	-	14,3	26,0	-	-	-	-	16,1	16,7	14,6	14,6	11,2	11,2	-
90	-	-	-	-	-	-	-	-	-	-	-	-	15,5	16,4	14,4	14,4	-	-	-
94	-	-	-	-	-	-	-	-	-	-	-	-	13,5	15,9	13,3	14,0	-	-	-
96	-	-	-	-	-	-	-	-	-	-	-	-	12,5	15,7	12,8	13,9	-	-	-
98	-	-	-	-	-	-	-	-	-	-	-	-	11,5	15,5	-	-	-	-	-
99	-	-	-	-	-	-	-	-	-	-	-	-	11,1	15,4	-	-	-	-	-

0t
65t
95t
125t
165t
205t
265t
325t

225 t		12 m x 12 m						9.8 m/s			360°			ISO			
		78 m															
		SSL+LF_1															
		12 m				24 m				36 m							
		0t-325t		0t-325t		0t-325t		0t-325t		0t-325t		0t-325t		0t-325t		0t-325t	
		15°		20°		30°		15°		20°		30°		15°		30°	
m	t	t	t	t	t	t	t	t	t	t	t	t	t	t	t	t	t
14	165,0	165,0	-	-	-	-	-	-	-	-	-	-	-	-	-	-	-
15	160,0	160,0	121,0	121,0	-	-	-	-	-	-	-	-	-	-	-	-	-
16	155,0	155,0	118,0	118,0	-	-	-	-	-	-	-	-	-	-	-	-	-
17	150,5	150,5	115,0	115,0	74,5	74,5	-	-	-	-	-	-	-	-	-	-	-
18	146,0	146,0	112,0	112,0	73,0	73,0	80,0	80,0	-	-	-	-	-	-	-	-	-
20	138,0	138,0	107,0	107,0	70,5	70,5	75,5	75,5	58,0	58,0	-	-	-	-	-	-	-
22	131,0	131,0	103,0	103,0	68,5	68,5	71,5	71,5	55,5	55,5	-	-	49,0	49,3	-	-	-
24	124,0	124,0	99,0	99,0	66,5	66,5	67,5	67,5	53,0	53,0	34,6	34,6	46,6	46,9	-	-	-
25	121,5	121,5	97,0	97,0	65,5	65,5	66,0	66,0	52,0	52,0	34,0	34,0	45,5	45,8	35,7	35,8	-
26	119,0	119,0	95,0	95,0	64,5	64,5	64,5	64,5	51,0	51,0	33,5	33,5	44,4	44,7	34,9	35,1	-
28	111,0	113,0	91,5	91,5	63,0	63,0	61,5	61,5	48,9	48,9	32,5	32,5	42,4	42,6	33,5	33,7	-
30	101,0	109,0	88,5	88,5	61,0	61,0	58,5	58,5	47,1	47,1	31,5	31,5	40,5	40,7	32,2	32,4	-
31	97,0	107,0	86,7	87,0	60,3	60,3	57,4	57,4	46,3	46,3	31,0	31,0	39,7	39,9	31,6	31,8	20,4
34	85,0	101,0	81,5	82,8	58,3	58,3	54,1	54,1	43,9	43,9	29,8	29,8	37,3	37,5	30,0	30,1	19,5
38	71,5	93,6	72,3	77,6	55,6	55,6	50,1	50,1	41,0	41,0	28,3	28,3	34,6	34,8	28,0	28,1	18,4
42	60,5	87,0	61,0	73,0	53,0	53,0	46,5	46,5	38,4	38,4	26,9	26,9	32,3	32,4	26,3	26,4	17,4
46	52,2	82,0	52,7	69,3	50,6	51,3	43,5	43,5	36,2	36,2	25,7	25,7	30,1	30,3	24,7	24,8	16,5
50	45,2	77,3	45,7	66,0	46,5	49,7	40,9	40,9	34,3	34,3	24,6	24,6	28,2	28,4	23,3	23,4	15,7
54	39,6	73,0	40,0	63,0	40,7	48,1	38,5	38,5	32,5	32,5	23,6	23,6	26,4	26,6	22,0	22,0	15,0
58	34,4	69,6	34,8	60,6	35,4	46,7	36,5	36,5	31,0	31,0	22,8	22,8	24,8	25,0	20,8	20,8	14,4
62	29,8	66,6	30,2	58,3	30,6	45,6	33,4	34,6	29,6	29,6	22,0	22,0	23,4	23,5	19,8	19,8	13,8
66	25,8	64,0	26,0	56,0	26,4	44,6	29,3	32,9	28,4	28,4	21,4	21,4	22,2	22,3	18,8	18,8	13,3
69	23,2	62,0	23,4	55,0	23,7	44,0	26,6	31,8	26,4	27,6	20,9	20,9	21,4	21,5	18,2	18,2	12,9
70	22,4	61,3	22,6	54,6	-	-	25,7	31,5	25,8	27,3	20,8	20,8	21,2	21,2	18,0	18,0	12,8
74	19,2	59,1	19,4	53,3	-	-	22,5	30,2	23,0	26,3	20,3	20,3	20,2	20,2	17,2	17,2	12,4
78	16,4	57,5	16,6	52,0	-	-	19,6	29,0	20,0	25,5	19,9	19,9	19,3	19,3	16,5	16,5	12,1
81	14,6	56,5	-	-	-	-	17,6	28,2	18,0	25,0	18,5	19,6	18,7	18,7	16,0	16,0	11,8
82	-	-	-	-	-	-	17,0	28,0	17,4	24,8	-	-	18,5	18,5	15,9	15,9	11,7
86	-	-	-	-	-	-	14,6	27,1	14,9	24,2	-	-	16,9	17,7	15,3	15,3	11,4
90	-	-	-	-	-	-	12,5	26,4	12,2	23,7	-	-	14,7	17,0	14,9	14,9	11,2
93	-	-	-	-	-	-	11,0	25,9	-	-	-	-	13,2	16,6	13,5	14,5	11,1
94	-	-	-	-	-	-	-	-	-	-	-	-	12,7	16,4	13,0	14,4	-
98	-	-	-	-	-	-	-	-	-	-	-	-	10,8	15,9	11,1	14,0	-
101	-	-	-	-	-	-	-	-	-	-	-	-	9,4	15,6	9,8	13,9	-
102	-	-	-	-	-	-	-	-	-	-	-	-	9,0	15,5	-	-	-
104	-	-	-	-	-	-	-	-	-	-	-	-	8,2	15,3	-	-	-



225 t		12 m x 12 m						9.8 m/s			360°			ISO			
84 m																	
SSL+LF_1																	
12 m						24 m						36 m					
0t-325t		0t-325t		0t-325t		0t-325t		0t-325t		0t-325t		0t-325t		0t-325t		0t-325t	
15°		20°		30°		15°		20°		30°		15°		20°		30°	
m	t	t	t	t	t	t	t	t	t	t	t	t	t	t	t	t	t
14	167,0	167,0	-	-	-	-	-	-	-	-	-	-	-	-	-	-	-
15	162,5	162,5	122,0	122,0	-	-	-	-	-	-	-	-	-	-	-	-	-
16	158,0	158,0	119,0	119,0	-	-	-	-	-	-	-	-	-	-	-	-	-
17	153,5	153,5	116,5	116,5	74,5	74,5	-	-	-	-	-	-	-	-	-	-	-
18	149,0	149,0	114,0	114,0	73,5	73,5	81,0	81,0	-	-	-	-	-	-	-	-	-
20	141,0	141,0	109,0	109,0	71,5	71,5	76,5	76,5	58,5	58,5	-	-	-	-	-	-	-
22	134,0	134,0	105,0	105,0	69,0	69,0	72,5	72,5	56,0	56,0	-	-	49,4	49,6	-	-	-
24	128,0	128,0	101,0	101,0	67,0	67,0	69,0	69,0	53,5	53,5	34,8	34,8	47,0	47,3	-	-	-
26	121,0	122,0	97,0	97,0	65,5	65,5	66,0	66,0	51,5	51,5	33,7	33,7	44,9	45,2	35,1	35,3	-
28	109,0	117,0	93,5	93,5	63,5	63,5	63,0	63,0	49,8	49,8	32,8	32,8	42,9	43,2	33,8	33,9	-
30	99,0	112,0	90,5	90,5	62,0	62,0	60,0	60,0	48,0	48,0	31,8	31,8	41,1	41,3	32,5	32,7	-
31	95,0	110,0	88,0	89,0	61,3	61,3	58,9	58,9	47,2	47,2	31,4	31,4	40,3	40,5	31,9	32,1	20,4
34	83,0	104,0	80,8	84,8	59,3	59,3	55,6	55,6	44,8	44,8	30,2	30,2	37,9	38,2	30,3	30,5	19,5
38	69,5	96,8	70,3	79,8	56,6	56,6	51,6	51,6	41,9	41,9	28,7	28,7	35,2	35,5	28,3	28,5	18,5
42	58,5	90,5	59,0	75,5	54,0	54,0	48,0	48,0	39,3	39,3	27,3	27,3	32,9	33,2	26,6	26,8	17,5
46	50,2	85,1	50,7	71,8	49,7	52,3	45,0	45,0	37,1	37,1	26,1	26,1	30,9	31,1	25,1	25,2	16,7
50	43,2	80,3	43,7	68,3	44,3	50,6	42,2	42,2	35,2	35,2	25,0	25,0	29,0	29,2	23,7	23,8	15,9
54	37,6	76,0	38,0	65,0	37,8	49,0	39,8	39,8	33,5	33,5	24,1	24,1	27,2	27,4	22,5	22,6	15,2
58	32,4	72,3	32,8	62,3	33,2	47,6	35,2	37,7	31,9	31,9	23,2	23,2	25,6	25,8	21,3	21,4	14,6
62	27,8	69,0	28,2	60,0	28,7	46,3	31,1	35,8	30,2	30,5	22,4	22,4	24,2	24,3	20,3	20,4	14,0
66	23,7	66,0	24,0	58,0	24,5	45,3	27,5	34,1	28,2	29,3	21,7	21,7	22,9	23,0	19,3	19,4	13,5
70	20,3	63,6	20,5	56,3	20,9	44,5	23,9	32,6	24,5	28,1	21,1	21,1	21,8	21,9	18,5	18,5	13,0
74	17,1	61,5	17,3	54,6	16,5	43,7	20,7	31,3	21,1	27,1	20,2	20,6	20,8	20,9	17,7	17,7	12,6
78	14,3	59,5	14,5	53,0	-	-	17,7	30,1	18,1	26,3	18,9	20,2	20,0	20,0	17,0	17,0	12,3
82	11,9	57,8	12,0	52,2	-	-	15,1	29,0	15,5	25,5	16,1	19,8	17,5	19,1	16,4	16,4	11,9
83	11,3	57,4	11,4	52,0	-	-	14,4	28,7	14,8	25,3	15,4	19,7	16,9	18,9	16,2	16,2	11,8
85	10,1	56,7	-	-	-	-	13,2	28,2	13,6	24,9	14,2	19,6	15,7	18,5	15,6	15,9	11,7
86	9,6	56,5	-	-	-	-	12,7	28,0	13,0	24,8	-	-	15,1	18,3	15,2	15,8	11,6
90	-	-	-	-	-	-	10,5	27,2	10,8	24,2	-	-	12,9	17,7	13,5	15,3	11,4
94	-	-	-	-	-	-	8,6	26,4	8,8	23,7	-	-	10,9	17,0	11,4	14,8	11,2
95	-	-	-	-	-	-	8,1	26,2	7,5	23,6	-	-	10,4	16,8	10,9	14,7	11,1
97	-	-	-	-	-	-	7,2	26,0	-	-	-	-	9,4	16,5	9,9	14,5	10,6
98	-	-	-	-	-	-	6,8	25,9	-	-	-	-	9,0	16,4	9,4	14,4	-
102	-	-	-	-	-	-	-	-	-	-	-	-	7,3	16,0	7,6	14,1	-
106	-	-	-	-	-	-	-	-	-	-	-	-	5,7	15,6	6,0	13,8	-
109	-	-	-	-	-	-	-	-	-	-	-	-	4,5	15,3	-	-	-



225 t		12 m x 12 m						9.8 m/s			360°			ISO					
90 m																			
SSL+LF_1																			
12 m						24 m						36 m							
0 t		325 t		0 t		325 t		0 t		325 t		0 t		325 t		0 t		325 t	
15°		20°		30°		15°		20°		30°		15°		20°		30°			
m	t	t	t	t	t	t	t	t	t	t	t	t	t	t	t	t	t		
15	165,0	165,0	-	-	-	-	-	-	-	-	-	-	-	-	-	-	-		
16	160,0	160,0	121,0	121,0	-	-	-	-	-	-	-	-	-	-	-	-	-		
18	152,0	152,0	116,0	116,0	74,0	74,0	-	-	-	-	-	-	-	-	-	-	-		
19	148,0	148,0	113,5	113,5	73,0	73,0	80,0	80,0	-	-	-	-	-	-	-	-	-		
20	144,0	144,0	111,0	111,0	72,0	72,0	78,0	78,0	-	-	-	-	-	-	-	-	-		
21	140,5	140,5	109,0	109,0	71,0	71,0	76,0	76,0	58,0	58,0	-	-	-	-	-	-	-		
22	137,0	137,0	107,0	107,0	70,0	70,0	74,0	74,0	56,5	56,5	-	-	-	-	-	-	-		
23	134,0	134,0	105,0	105,0	69,0	69,0	72,2	72,2	55,5	55,5	-	-	48,4	48,8	-	-	-		
24	131,0	131,0	103,0	103,0	68,0	68,0	70,5	70,5	54,5	54,5	-	-	47,3	47,7	-	-	-		
25	125,5	128,0	101,0	101,0	67,0	67,0	68,7	68,7	53,5	53,5	34,4	34,4	46,3	46,6	-	-	-		
26	120,0	125,0	99,0	99,0	66,0	66,0	67,0	67,0	52,5	52,5	33,9	33,9	45,3	45,6	35,2	35,4	-		
28	108,0	120,0	95,5	95,5	64,5	64,5	64,5	64,5	50,5	50,5	33,0	33,0	43,4	43,7	34,0	34,1	-		
30	97,5	115,0	92,5	92,5	63,0	63,0	61,5	61,5	48,8	48,8	32,1	32,1	41,6	41,9	32,8	32,9	-		
32	89,5	111,0	86,5	89,6	61,5	61,5	59,1	59,1	47,2	47,2	31,3	31,3	40,0	40,3	31,7	31,8	20,1		
34	81,5	107,0	80,5	86,8	60,0	60,0	56,8	56,8	45,6	45,6	30,5	30,5	38,5	38,8	30,6	30,7	19,5		
38	67,8	99,8	68,8	81,8	57,3	57,3	52,8	52,8	42,8	42,8	29,0	29,0	35,8	36,1	28,7	28,8	18,5		
42	56,5	93,5	57,5	77,5	55,0	55,0	49,4	49,4	40,2	40,2	27,6	27,6	33,5	33,8	27,0	27,1	17,6		
46	48,3	88,1	49,1	73,8	48,9	53,0	46,4	46,4	38,0	38,0	26,4	26,4	31,5	31,8	25,6	25,7	16,8		
50	41,1	83,3	41,7	70,3	42,6	51,3	43,0	43,6	36,1	36,1	25,4	25,4	29,7	29,9	24,2	24,3	16,0		
54	34,8	79,0	35,3	67,0	36,1	49,9	39,2	41,1	34,3	34,3	24,4	24,4	28,0	28,1	22,9	23,1	15,4		
58	30,3	75,3	30,7	64,3	31,5	48,5	34,0	39,0	32,7	32,7	23,6	23,6	26,4	26,5	21,8	21,9	14,7		
62	26,0	71,8	26,4	61,8	27,0	47,2	29,5	37,1	30,2	31,3	22,8	22,8	24,9	25,1	20,8	20,8	14,1		
66	21,9	68,5	22,2	59,5	22,8	46,0	25,9	35,3	26,6	30,1	22,1	22,1	23,6	23,8	19,8	19,9	13,6		
70	18,4	65,8	18,7	57,8	19,2	45,0	22,3	33,7	23,0	28,9	21,5	21,5	22,4	22,6	18,9	19,0	13,2		
74	15,3	63,5	15,5	56,1	16,0	44,2	19,0	32,3	19,6	27,9	19,9	20,9	20,8	21,6	18,1	18,2	12,8		
78	12,5	61,5	12,7	54,5	13,0	43,6	16,0	31,1	16,6	27,0	17,4	20,5	18,7	20,7	17,5	17,5	12,4		
82	10,0	59,5	10,2	53,1	-	-	13,4	29,9	13,9	26,2	14,6	20,1	16,1	19,8	16,1	16,8	12,0		
86	7,7	57,8	7,9	52,0	-	-	11,1	28,9	11,4	25,4	12,1	19,7	13,6	19,0	14,3	16,2	11,8		
88	6,7	57,1	6,9	51,5	-	-	10,0	28,4	10,3	25,1	10,9	19,5	12,4	18,6	13,1	15,9	11,7		
90	5,7	56,5	-	-	-	-	8,9	28,0	9,2	24,8	8,0	19,4	11,3	18,3	12,0	15,7	11,6		
91	5,3	56,0	-	-	-	-	8,4	27,8	8,7	24,6	-	-	10,8	18,1	11,4	15,5	11,3		
94	-	-	-	-	-	-	6,9	27,2	7,2	24,2	-	-	9,3	17,6	9,9	15,2	10,4		
98	-	-	-	-	-	-	5,1	26,5	5,3	23,8	-	-	7,4	17,0	8,0	14,8	8,8		
100	-	-	-	-	-	-	4,2	26,2	3,7	23,6	-	-	6,5	16,7	7,1	14,6	7,8		
101	-	-	-	-	-	-	3,8	26,1	-	-	-	-	6,1	16,6	6,6	14,5	7,3		
102	-	-	-	-	-	-	-	25,9	-	-	-	-	5,7	16,5	6,2	14,4	-		
103	-	-	-	-	-	-	-	25,8	-	-	-	-	5,3	16,4	5,7	14,3	-		
106	-	-	-	-	-	-	-	-	-	-	-	-	4,1	16,0	4,5	14,1	-		
107	-	-	-	-	-	-	-	-	-	-	-	-	3,7	15,9	4,1	14,0	-		
108	-	-	-	-	-	-	-	-	-	-	-	-	-	15,8	3,7	13,9	-		
110	-	-	-	-	-	-	-	-	-	-	-	-	-	15,6	-	13,7	-		
111	-	-	-	-	-	-	-	-	-	-	-	-	-	15,5	-	13,7	-		
114	-	-	-	-	-	-	-	-	-	-	-	-	-	15,3	-	-	-		
115	-	-	-	-	-	-	-	-	-	-	-	-	-	15,2	-	-	-		



225 t		12 m x 12 m								9.8 m/s			360°			ISO			
		96 m																	
		SSL+LF_1																	
		12 m				24 m				36 m									
		0t-325t		0t-325t		0t-325t		0t-325t		0t-325t		0t-325t		0t-325t		0t-325t		0t-325t	
		15°		20°		30°		15°		20°		30°		15°		20°		30°	
m	t	t	t	t	t	t	t	t	t	t	t	t	t	t	t	t	t	t	t
15	167,0	167,0	-	-	-	-	-	-	-	-	-	-	-	-	-	-	-	-	-
16	163,0	163,0	122,0	122,0	-	-	-	-	-	-	-	-	-	-	-	-	-	-	-
18	155,0	155,0	117,0	117,0	74,5	74,5	-	-	-	-	-	-	-	-	-	-	-	-	-
19	151,0	151,0	114,5	114,5	73,5	73,5	81,0	81,0	-	-	-	-	-	-	-	-	-	-	-
20	147,0	147,0	112,0	112,0	72,5	72,5	79,0	79,0	-	-	-	-	-	-	-	-	-	-	-
21	143,5	143,5	110,0	110,0	71,5	71,5	77,0	77,0	58,5	58,5	-	-	-	-	-	-	-	-	-
22	140,0	140,0	108,0	108,0	70,5	70,5	75,0	75,0	57,0	57,0	-	-	-	-	-	-	-	-	-
23	136,5	137,0	106,0	106,0	69,5	69,5	73,2	73,2	56,0	56,0	-	-	48,7	49,0	-	-	-	-	-
24	133,0	134,0	104,0	104,0	68,5	68,5	71,5	71,5	55,0	55,0	-	-	47,6	48,0	-	-	-	-	-
25	125,5	131,0	102,5	102,5	67,7	67,7	70,0	70,0	54,0	54,0	34,6	34,6	46,6	47,0	-	-	-	-	-
26	118,0	128,0	101,0	101,0	67,0	67,0	68,5	68,5	53,0	53,0	34,1	34,1	45,7	46,0	-	-	-	-	-
27	112,0	125,5	99,2	99,2	66,0	66,0	67,0	67,0	52,0	52,0	33,6	33,6	44,7	45,0	34,7	34,9	-	-	-
28	106,0	123,0	97,5	97,5	65,0	65,0	65,5	65,5	51,0	51,0	33,2	33,2	43,8	44,1	34,1	34,3	-	-	-
30	95,5	118,0	94,5	94,5	63,5	63,5	63,0	63,0	49,5	49,5	32,3	32,3	42,1	42,4	33,0	33,2	-	-	-
32	87,5	114,0	87,1	91,6	62,1	62,1	60,6	60,6	47,9	47,9	31,5	31,5	40,6	40,9	31,9	32,1	20,1	20,1	-
34	79,5	110,0	79,8	88,8	60,8	60,8	58,3	58,3	46,4	46,4	30,7	30,7	39,1	39,4	30,9	31,0	19,5	19,6	-
38	65,8	102,8	66,8	83,8	58,3	58,3	54,1	54,1	43,6	43,6	29,3	29,3	36,4	36,7	29,0	29,1	18,5	18,6	-
42	54,5	96,5	55,5	79,5	56,0	56,0	50,5	50,5	41,1	41,1	28,0	28,0	34,1	34,4	27,3	27,5	17,7	17,8	-
46	46,3	91,1	47,1	75,5	48,0	48,0	47,5	47,5	38,9	38,9	26,8	26,8	32,1	32,4	25,9	26,1	16,9	17,0	-
50	39,1	86,1	39,7	72,0	40,7	40,7	43,2	43,2	37,0	37,0	25,8	25,8	30,3	30,6	24,6	24,7	16,1	16,2	-
54	32,7	81,5	33,3	69,0	34,2	34,2	50,5	50,5	35,2	35,2	24,8	24,8	28,7	28,8	23,4	23,5	15,5	15,6	-
58	28,2	77,8	28,7	66,3	28,9	28,9	49,2	49,2	32,1	32,1	23,9	23,9	27,1	27,2	22,2	22,3	14,9	15,0	-
62	23,9	74,3	24,4	63,8	24,4	24,4	48,0	48,0	27,4	27,4	23,2	23,2	25,7	25,8	21,2	21,3	14,3	14,4	-
66	19,8	71,0	20,2	61,5	20,8	20,8	46,8	46,8	23,2	23,2	22,5	22,5	24,3	24,5	20,2	20,3	13,8	13,9	-
70	16,3	68,3	16,6	59,5	17,2	17,2	45,8	45,8	20,1	20,1	21,8	21,8	22,0	22,3	19,4	19,5	13,3	13,4	-
74	13,1	65,8	13,4	57,6	13,9	13,9	44,9	44,9	17,1	17,1	21,2	21,2	19,6	19,7	18,6	18,7	12,9	13,0	-
78	10,3	63,5	10,6	56,0	11,0	11,0	44,1	44,1	14,1	14,1	20,7	20,7	17,0	17,1	17,9	18,0	12,6	12,6	-
82	7,9	61,5	8,1	54,6	8,4	8,4	43,5	43,5	11,5	11,5	20,3	20,3	14,3	14,4	15,1	15,2	12,2	12,2	-
83	7,3	61,0	7,5	54,3	6,3	6,3	43,4	43,4	10,8	10,8	19,6	19,6	13,6	13,7	14,4	14,5	12,1	12,1	-
86	5,6	59,7	5,8	53,4	-	-	42,9	42,9	9,1	9,1	19,9	19,9	11,8	11,9	12,6	12,7	11,9	11,9	-
90	3,6	58,0	3,7	52,0	-	-	42,0	42,0	7,3	7,3	19,6	19,6	9,5	9,6	11,9	12,0	11,5	11,5	-
93	-	57,0	-	51,5	-	-	41,5	41,5	5,4	5,4	19,3	19,3	8,0	8,1	11,8	11,9	11,5	11,5	-
94	-	56,6	-	-	-	-	41,1	41,1	4,9	4,9	19,3	19,3	7,5	7,6	11,7	11,8	11,4	11,4	-
97	-	56,0	-	-	-	-	40,7	40,7	3,6	3,6	19,3	19,3	6,0	6,1	11,6	11,7	11,2	11,2	-
98	-	-	-	-	-	-	40,3	40,3	-	-	19,3	19,3	5,6	5,7	11,5	11,6	11,2	11,2	-
102	-	-	-	-	-	-	39,9	39,9	-	-	19,3	19,3	3,9	4,0	11,4	11,5	11,0	11,0	-
104	-	-	-	-	-	-	39,5	39,5	-	-	19,3	19,3	-	19,4	11,3	11,4	10,9	10,9	-
105	-	-	-	-	-	-	39,1	39,1	-	-	19,3	19,3	-	19,4	11,2	11,3	10,9	10,9	-
106	-	-	-	-	-	-	38,7	38,7	-	-	19,3	19,3	-	19,4	11,1	11,2	10,9	10,9	-
108	-	-	-	-	-	-	38,3	38,3	-	-	19,3	19,3	-	19,4	11,0	11,1	10,9	10,9	-
110	-	-	-	-	-	-	37,9	37,9	-	-	19,3	19,3	-	19,4	10,9	11,0	10,9	10,9	-
114	-	-	-	-	-	-	37,5	37,5	-	-	19,3	19,3	-	19,4	10,8	10,9	10,9	10,9	-
116	-	-	-	-	-	-	37,1	37,1	-	-	19,3	19,3	-	19,4	10,7	10,8	10,9	10,9	-
118	-	-	-	-	-	-	36,7	36,7	-	-	19,3	19,3	-	19,4	10,6	10,7	10,9	10,9	-
120	-	-	-	-	-	-	36,3	36,3	-	-	19,3	19,3	-	19,4	10,5	10,6	10,9	10,9	-

	0t	65t	95t	125t	165t	205t	265t	325t
--	----	-----	-----	------	------	------	------	------

225 t		12 m x 12 m						9.8 m/s			360°			ISO			
102 m																	
SSL+LF_1																	
12 m						24 m						36 m					
0t-325t		0t-325t		0t-325t		0t-325t		0t-325t		0t-325t		0t-325t		0t-325t		0t-325t	
15°		20°		30°		15°		20°		30°		15°		20°		30°	
m	t	t	t	t	t	t	t	t	t	t	t	t	t	t	t	t	t
16	163,0	165,0	-	-	-	-	-	-	-	-	-	-	-	-	-	-	-
17	160,0	161,0	121,0	121,0	-	-	-	-	-	-	-	-	-	-	-	-	-
18	157,0	157,0	118,0	118,0	-	-	-	-	-	-	-	-	-	-	-	-	-
19	153,5	153,5	116,0	116,0	73,5	73,5	-	-	-	-	-	-	-	-	-	-	-
20	150,0	150,0	114,0	114,0	72,5	72,5	79,5	80,0	-	-	-	-	-	-	-	-	-
22	143,0	143,0	110,0	110,0	71,0	71,0	76,0	76,0	57,5	57,5	-	-	-	-	-	-	-
24	131,0	137,0	106,0	106,0	69,0	69,0	72,5	72,5	55,5	55,5	-	-	47,9	48,3	-	-	-
26	117,0	131,0	102,0	102,0	67,5	67,5	69,5	69,5	53,5	53,5	34,2	34,2	46,0	46,3	-	-	-
27	110,5	128,5	100,5	100,5	66,7	66,7	68,0	68,0	52,5	52,5	33,7	33,7	45,1	45,4	34,9	35,1	-
28	104,0	126,0	99,0	99,0	66,0	66,0	66,5	66,5	51,5	51,5	33,3	33,3	44,2	44,6	34,3	34,5	-
30	94,0	121,0	95,0	96,0	64,5	64,5	64,0	64,0	50,0	50,0	32,5	32,5	42,5	42,9	33,2	33,3	-
33	82,0	115,0	83,0	92,0	62,2	62,2	60,7	60,7	47,8	47,8	31,3	31,3	40,3	40,6	31,7	31,8	19,8
34	78,0	113,0	79,0	90,6	61,5	61,5	59,6	59,6	47,0	47,0	30,9	30,9	39,5	39,9	31,2	31,3	19,5
38	64,3	105,6	65,1	85,6	58,3	58,3	55,5	55,5	44,3	44,3	29,5	29,5	36,9	37,2	29,3	29,4	18,6
42	53,0	99,0	53,5	81,0	55,0	57,0	51,5	51,5	41,8	41,8	28,3	28,3	34,6	34,9	27,6	27,8	17,8
46	44,6	93,6	45,3	77,3	46,6	55,0	47,6	48,7	39,6	39,6	27,1	27,1	32,7	33,0	26,2	26,4	17,0
50	37,3	88,6	37,9	73,8	39,1	53,1	42,4	46,1	37,7	37,7	26,1	26,1	30,9	31,2	25,0	25,1	16,2
54	30,9	84,0	31,5	70,5	32,5	51,5	35,8	43,5	35,9	35,9	25,1	25,1	29,3	29,5	23,8	23,9	15,6
58	25,8	80,3	26,3	67,8	27,2	50,0	30,5	41,3	31,2	31,2	24,3	24,3	27,7	27,9	22,6	22,8	15,0
62	21,5	76,8	22,0	65,3	22,7	48,7	25,7	39,3	26,7	32,9	23,5	23,5	26,2	26,5	21,6	21,8	14,5
66	17,9	73,5	18,4	63,0	19,0	47,5	21,5	37,5	22,4	31,6	22,8	22,8	24,8	25,2	20,7	20,8	14,0
70	14,5	70,5	14,8	61,0	15,4	46,4	18,4	35,9	19,2	30,4	19,7	22,1	21,1	24,0	19,8	19,9	13,5
74	11,3	67,8	11,6	59,0	12,2	45,4	15,4	34,4	16,1	29,3	16,8	21,5	17,7	22,9	18,1	19,1	13,1
78	8,4	65,5	8,7	57,0	9,2	44,6	12,4	33,1	13,1	28,3	14,2	21,0	14,7	21,9	15,7	18,4	12,7
82	6,0	63,5	6,2	55,6	6,6	43,9	9,8	31,9	10,4	27,4	11,4	20,6	12,5	21,0	13,4	17,7	12,3
86	3,7	61,5	3,9	54,5	4,2	43,4	7,4	30,7	7,9	26,6	8,8	20,2	10,2	20,2	11,1	17,1	11,5
87	-	61,0	-	54,1	3,7	43,2	6,8	30,5	7,4	26,4	8,2	20,1	9,6	20,0	10,5	16,9	11,1
90	-	59,5	-	53,0	-	-	5,2	29,7	5,7	25,9	6,4	19,8	7,9	19,4	8,7	16,5	10,1
93	-	58,5	-	52,2	-	-	3,7	29,1	4,1	25,4	4,8	19,6	6,4	18,9	7,1	16,1	8,4
94	-	58,1	-	52,0	-	-	-	28,8	3,6	25,3	4,3	19,5	5,9	18,7	6,6	15,9	7,9
95	-	57,8	-	51,7	-	-	-	28,6	-	25,1	3,8	19,4	5,4	18,6	6,1	15,8	7,3
98	-	55,3	-	51,5	-	-	-	28,0	-	24,7	-	19,3	3,9	18,1	4,6	15,5	5,8
99	-	54,2	-	37,3	-	-	-	27,8	-	24,6	-	-	3,5	17,9	4,1	15,4	5,3
100	-	53,1	-	-	-	-	-	27,6	-	24,4	-	-	-	17,8	3,7	15,3	4,8
102	-	51,0	-	-	-	-	-	27,3	-	24,2	-	-	-	17,5	-	15,1	3,8
106	-	-	-	-	-	-	-	26,6	-	23,8	-	-	-	16,9	-	14,7	-
110	-	-	-	-	-	-	-	26,0	-	23,4	-	-	-	16,4	-	14,3	-
113	-	-	-	-	-	-	-	25,7	-	-	-	-	-	16,1	-	14,0	-
114	-	-	-	-	-	-	-	-	-	-	-	-	-	16,0	-	14,0	-
118	-	-	-	-	-	-	-	-	-	-	-	-	-	15,7	-	13,8	-
121	-	-	-	-	-	-	-	-	-	-	-	-	-	15,4	-	13,6	-
122	-	-	-	-	-	-	-	-	-	-	-	-	-	15,3	-	-	-
125	-	-	-	-	-	-	-	-	-	-	-	-	-	15,1	-	-	-

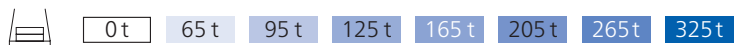

225 t		12 m x 12 m						9.8 m/s			360°			ISO		
		108 m														
		SSL+LF_1														
		12 m				24 m				36 m						
		0t-325t		0t-325t		0t-325t		0t-325t		0t-325t		0t-325t		0t-325t		
		15°		20°		30°		15°		20°		30°		15°		
m	t	t	t	t	t	t	t	t	t	t	t	t	t	t	t	
16	152,0	157,0	-	-	-	-	-	-	-	-	-	-	-	-	-	
17	152,0	156,5	122,0	122,0	-	-	-	-	-	-	-	-	-	-	-	
18	152,0	156,0	119,0	119,0	-	-	-	-	-	-	-	-	-	-	-	
19	151,5	154,0	117,0	117,0	74,0	74,0	-	-	-	-	-	-	-	-	-	
20	151,0	152,0	115,0	115,0	73,0	73,0	80,5	80,5	-	-	-	-	-	-	-	
22	143,0	145,0	111,0	111,0	71,5	71,5	77,0	77,0	58,0	58,0	-	-	-	-	-	
24	129,0	139,0	107,0	107,0	69,5	69,5	73,5	73,5	56,0	56,0	-	-	48,1	48,5	-	
26	115,0	134,0	104,0	104,0	68,0	68,0	70,5	70,5	54,0	54,0	34,4	34,4	46,2	46,7	-	
28	102,0	129,0	100,0	100,0	66,5	66,5	68,0	68,0	52,5	52,5	33,5	33,5	44,6	44,9	34,4	
30	92,0	124,0	93,5	97,5	65,0	65,0	65,0	65,0	50,5	50,5	32,7	32,7	42,9	43,3	33,3	
33	80,0	118,0	81,2	93,5	63,0	63,0	61,7	61,7	48,4	48,4	31,5	31,5	40,7	41,1	31,8	
34	76,0	116,0	77,1	92,1	62,3	62,3	60,6	60,6	47,7	47,7	31,1	31,1	40,0	40,4	31,3	
38	62,3	108,6	63,1	87,3	58,3	59,8	56,6	56,6	45,0	45,0	29,7	29,7	37,4	37,8	29,5	
42	51,0	102,0	51,5	83,0	53,0	57,5	53,0	53,0	42,6	42,6	28,5	28,5	35,1	35,4	27,9	
46	42,6	96,3	43,3	79,0	44,6	55,5	46,9	50,0	40,4	40,4	27,4	27,4	33,3	33,6	26,5	
50	35,2	91,1	35,9	75,3	37,1	53,6	40,5	47,2	38,0	38,5	26,4	26,4	31,5	31,8	25,3	
54	28,8	86,5	29,5	72,0	30,5	52,0	33,9	44,7	35,2	36,7	25,4	25,4	29,9	30,2	24,2	
58	23,7	82,5	24,3	69,3	25,2	50,6	28,6	42,5	29,8	35,1	24,6	24,6	28,4	28,6	23,0	
62	19,4	78,8	19,9	66,8	20,4	49,4	23,8	40,4	24,9	33,6	23,5	23,8	26,1	27,2	22,0	
66	15,8	75,5	16,3	64,5	16,2	48,2	19,6	38,6	20,5	32,3	22,2	23,1	23,0	25,9	21,1	
70	12,3	72,5	12,7	62,5	13,2	47,0	16,0	37,0	16,9	31,1	18,4	22,4	19,3	24,7	19,5	
74	9,1	69,8	9,5	60,5	10,1	46,0	13,0	35,4	13,8	30,0	15,1	21,8	15,9	23,5	17,2	
78	6,3	67,5	6,6	58,5	7,1	45,2	10,4	34,0	11,2	29,0	12,4	21,3	12,9	22,5	14,0	
82	3,8	65,3	4,1	57,0	4,5	44,4	7,8	32,8	8,5	28,0	9,6	20,8	10,7	21,6	11,7	
83	-	64,6	-	56,5	3,9	44,3	7,2	32,5	7,8	27,8	8,9	20,7	10,1	21,4	11,1	
86	-	63,1	-	55,5	-	43,8	5,4	31,6	6,0	27,2	7,0	20,4	8,4	20,8	9,4	
89	-	61,9	-	54,7	-	43,3	3,7	30,8	4,3	26,7	5,2	20,1	6,6	20,2	7,6	
90	-	61,5	-	54,5	-	43,2	-	30,6	3,8	26,5	4,6	20,0	6,1	20,0	7,0	
92	-	60,6	-	53,8	-	43,0	-	30,1	-	26,1	3,5	19,8	5,0	19,6	5,9	
94	-	59,8	-	53,1	-	-	-	29,6	-	25,8	-	19,6	4,0	19,3	4,9	
95	-	59,4	-	52,8	-	-	-	29,4	-	25,6	-	19,5	3,5	19,1	4,4	
96	-	59,0	-	52,5	-	-	-	29,2	-	25,5	-	19,5	-	18,9	3,9	
98	-	56,5	-	52,1	-	-	-	28,8	-	25,2	-	19,4	-	18,6	-	
99	-	55,2	-	52,0	-	-	-	28,6	-	25,0	-	19,3	-	18,4	-	
102	-	51,5	-	51,5	-	-	-	28,0	-	24,6	-	19,2	-	18,0	-	
103	-	50,2	-	50,5	-	-	-	27,8	-	24,5	-	19,1	-	17,8	-	
104	-	48,9	-	31,8	-	-	-	27,6	-	24,4	-	-	-	17,7	-	
106	-	46,3	-	-	-	-	-	27,3	-	24,1	-	-	-	17,4	-	
107	-	45,4	-	-	-	-	-	27,1	-	24,0	-	-	-	17,3	-	
110	-	-	-	-	-	-	-	26,7	-	23,7	-	-	-	16,9	-	
114	-	-	-	-	-	-	-	26,1	-	23,4	-	-	-	16,5	-	
115	-	-	-	-	-	-	-	26,0	-	23,3	-	-	-	16,4	-	
118	-	-	-	-	-	-	-	25,7	-	-	-	-	-	16,1	-	
119	-	-	-	-	-	-	-	25,6	-	-	-	-	-	16,0	-	
122	-	-	-	-	-	-	-	-	-	-	-	-	-	15,7	-	
126	-	-	-	-	-	-	-	-	-	-	-	-	-	15,4	-	
127	-	-	-	-	-	-	-	-	-	-	-	-	-	15,3	-	
130	-	-	-	-	-	-	-	-	-	-	-	-	-	15,1	-	



Notes

PC 3800-1

Notizen · Notes · Nota · Notas · Notas ·
пометы, комментарии, примечания

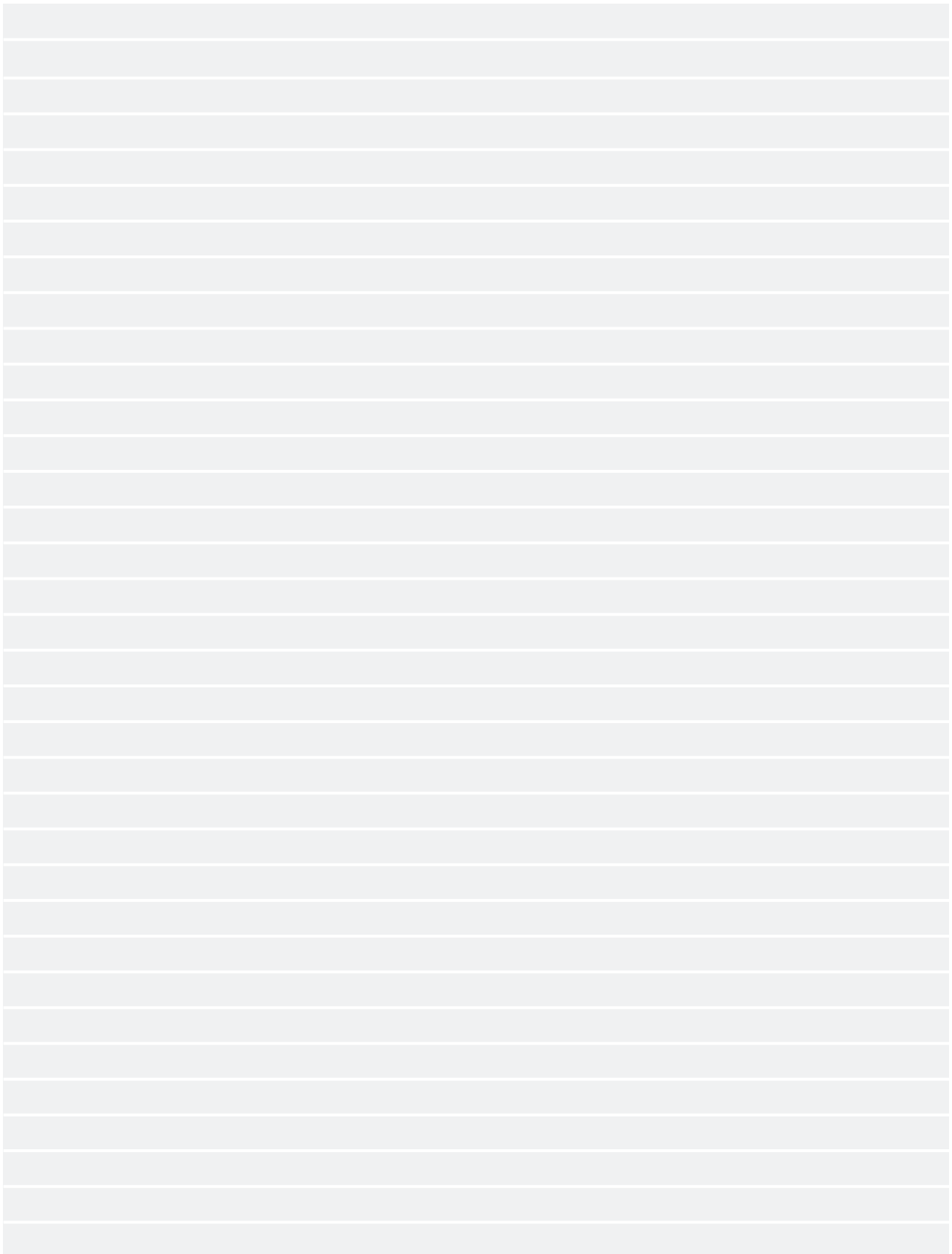

LSL+LF_3, LSL+LF_4, LSL+LF_6, LSL+LF_8, LSL+LF_10, LSL+LF_12

PC 3800-1

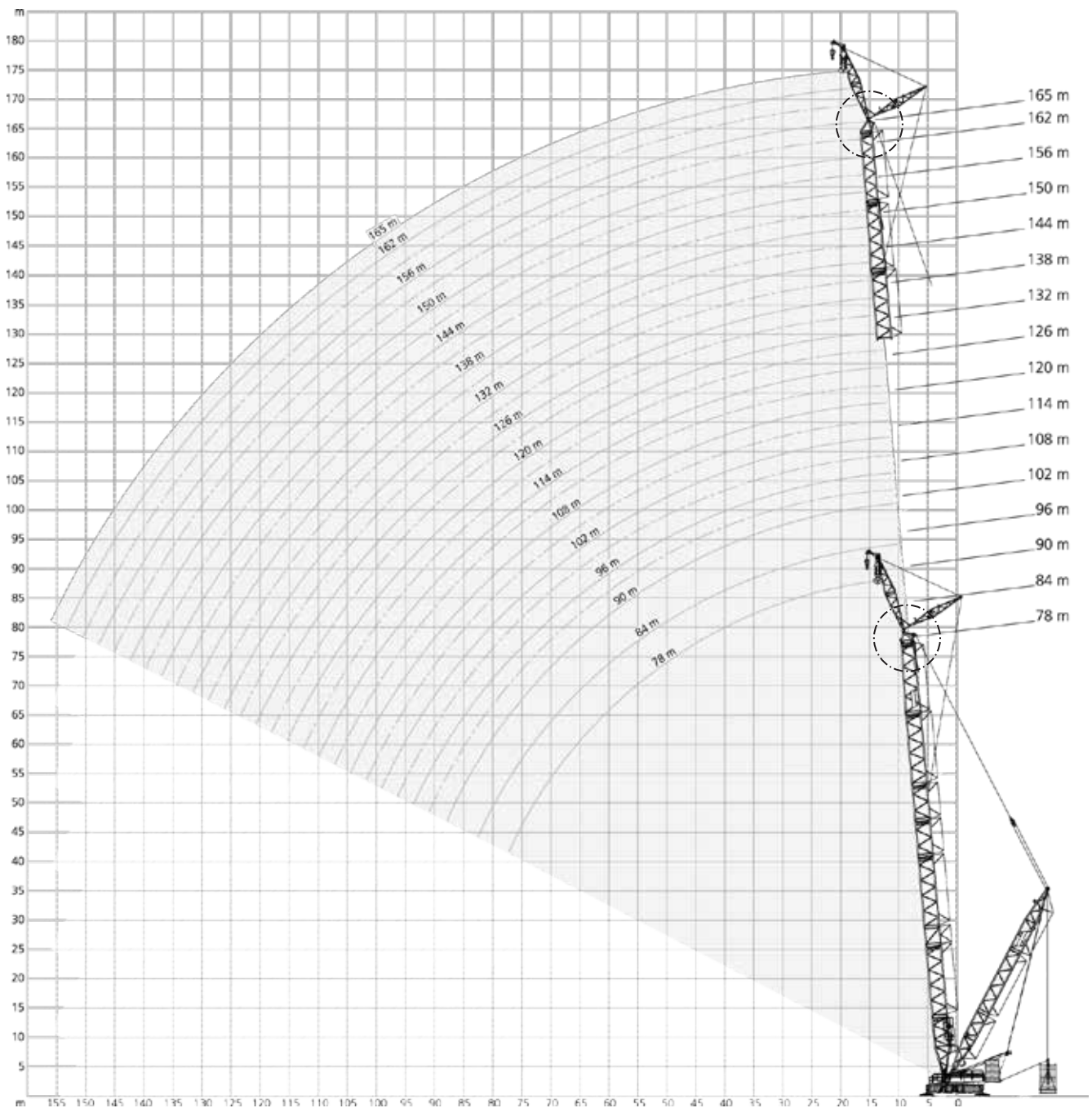
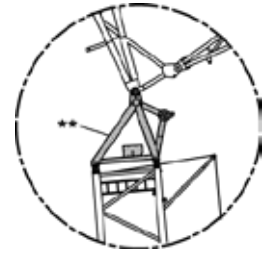

** Option · Option · En option · Opzione · Opcion · Opcional · Опция

225 t		12 m x 12 m												9.8 m/s		360°		ISO		
72 m				78 m				84 m												
LSL+LF_2				LSL+LF_3				LSL+LF_2				LSL+LF_3								
12 m																				
0 t		0 t-325 t		0 t		0 t-325 t		0 t		0 t-325 t		0 t		0 t-325 t		0 t		0 t-325 t		
15°		20°		30°		15°		20°		30°		15°		20°		30°		15°		
m	t	t	t	t	t	t	t	t	t	t	t	t	t	t	t	t	t	t	t	m
12	178,0	178,0	-	-	-	-	-	-	-	-	-	-	-	-	-	-	-	-	-	12
13	172,5	172,5	132,0	-	176,0	176,0	-	-	-	-	-	-	178,0	178,0	-	-	-	-	-	13
14	167,0	167,0	128,0	-	170,0	170,0	130,0	-	151,0	155,0	125,0	173,0	173,0	132,0	-	153,0	159,0	126,0	14	
15	162,0	162,0	125,0	81,5	165,0	165,0	127,0	-	148,0	150,5	122,0	168,5	168,5	129,0	-	151,0	155,5	123,0	15	
16	157,0	157,0	122,0	80,0	160,0	160,0	124,0	81,0	145,0	146,0	119,0	164,0	164,0	126,0	81,5	149,0	152,0	120,0	16	
18	148,0	148,0	116,0	77,5	151,0	151,0	118,0	78,0	138,0	139,0	113,0	155,0	155,0	120,0	79,0	144,0	146,0	115,0	18	
20	140,0	140,0	111,0	74,5	143,0	143,0	113,0	75,5	132,0	132,0	108,0	147,0	147,0	115,0	76,5	138,0	139,0	110,0	20	
22	132,0	132,0	106,0	72,5	136,0	136,0	108,0	73,5	125,5	126,0	104,0	140,0	140,0	111,0	74,0	132,0	133,0	106,0	22	
24	126,0	126,0	102,0	70,0	130,0	130,0	104,0	71,0	119,0	120,0	100,0	133,0	133,0	106,0	72,0	126,0	127,0	102,0	24	
26	120,0	120,0	98,0	68,0	124,0	124,0	100,0	69,0	114,5	115,5	96,5	124,0	128,0	102,0	70,0	119,0	121,5	98,5	26	
28	115,0	115,0	94,0	66,0	113,0	119,0	96,5	67,0	110,0	111,0	93,5	112,0	122,0	99,0	68,0	112,0	116,0	95,5	28	
30	105,0	110,0	90,5	64,0	103,0	114,0	93,5	65,5	102,5	106,5	90,5	102,0	117,0	95,5	66,5	102,5	112,0	92,5	30	
34	89,3	102,0	84,8	61,0	87,3	105,3	87,5	62,1	87,5	98,7	84,8	86,0	109,0	89,8	63,5	85,5	104,5	86,8	34	
38	76,0	94,6	79,6	58,1	74,0	97,8	82,1	59,3	74,5	92,3	79,5	72,5	101,6	84,6	60,6	72,5	97,6	81,6	38	
42	65,0	88,0	75,0	55,5	63,0	91,5	77,5	57,0	63,5	86,0	74,5	61,5	95,0	80,0	58,0	61,5	91,0	77,0	42	
46	57,3	83,0	71,3	53,5	54,6	86,5	73,5	54,6	55,1	80,6	70,8	53,5	89,6	76,0	56,0	53,2	85,6	73,0	46	
50	50,4	78,3	67,8	51,6	47,8	81,8	70,0	52,6	48,2	76,1	67,5	46,7	84,8	72,3	54,0	46,2	80,8	69,5	50	
54	44,4	74,0	64,5	50,0	42,4	77,5	67,0	51,0	42,6	72,5	64,5	41,1	80,5	69,0	52,0	40,6	76,5	66,5	54	
58	39,3	70,6	62,1	48,8	37,3	73,8	64,3	49,8	37,4	69,5	62,1	36,0	76,5	66,3	50,6	35,4	73,1	64,1	58	
62	34,8	67,6	60,0	47,7	32,7	70,5	61,8	48,6	32,8	66,6	60,0	31,4	73,0	63,8	49,4	30,8	70,1	61,8	62	
65	31,8	65,6	58,5	47,0	29,7	68,2	60,0	47,7	29,7	64,6	58,5	28,4	70,7	62,0	48,5	27,7	68,1	60,0	65	
66	30,8	65,0	58,0	-	28,7	67,5	59,5	47,5	28,7	64,0	58,0	27,4	70,0	61,5	48,3	26,7	67,5	59,5	66	
69	28,3	63,2	56,7	-	26,2	65,7	58,2	46,9	26,1	62,2	56,7	24,8	68,0	60,0	47,6	24,1	65,5	58,2	69	
70	27,4	62,6	56,3	-	25,3	65,1	57,8	-	25,3	61,6	56,3	24,0	67,3	59,5	47,4	23,3	64,8	57,8	70	
73	25,0	61,1	55,5	-	23,0	63,5	56,6	-	22,9	60,0	55,1	21,6	65,5	58,1	46,8	20,8	63,0	56,5	73	
74	24,3	60,7	-	-	22,3	63,0	56,3	-	22,2	59,6	54,8	20,9	65,0	57,8	-	20,1	62,5	56,1	74	
76	22,9	60,0	-	-	20,9	62,0	55,6	-	20,8	58,8	54,1	19,5	64,0	57,1	-	18,7	61,5	55,3	76	
78	-	-	-	-	19,5	61,0	55,0	-	19,4	58,0	53,5	18,1	63,0	56,5	-	17,3	60,5	54,5	78	
81	-	-	-	-	17,6	60,0	-	-	17,5	57,0	-	16,3	61,7	55,6	-	15,5	59,2	53,6	81	
82	-	-	-	-	-	-	-	-	-	-	-	15,7	61,3	55,3	-	14,9	58,8	53,3	82	
83	-	-	-	-	-	-	-	-	-	-	-	15,1	60,9	55,0	-	14,3	58,4	53,0	83	
86	-	-	-	-	-	-	-	-	-	-	-	13,5	59,5	-	-	12,6	57,5	-	86	

0t
65t
95t
125t
165t
205t
265t
325t

225 t		12 m x 12 m				9.8 m/s		360°		ISO		
90 m		12 m				93 m						
LSL+LF_2		LSL+LF_3				LSL+LF_6						
0 t		0t-325t				0 t		0t-325t		0 t		
15°		20°		30°		15°		20°		15°		
20°						20°				20°		
m	t	t	t	t	t	t	t	t	t	t	t	m
14	172,0	176,0	-	-	-	-	-	155,0	-	157,0	157,0	14
15	169,0	171,5	130,0	-	146,0	151,0	128,0	151,0	117,0	152,5	152,5	15
16	166,0	167,0	127,0	-	144,0	149,0	125,0	147,0	114,0	148,0	148,0	16
17	162,0	162,5	124,5	80,5	142,5	147,0	122,5	143,5	111,5	144,5	144,5	17
18	158,0	158,0	122,0	79,5	141,0	145,0	120,0	140,0	109,0	141,0	141,0	18
20	150,0	150,0	117,0	77,0	137,0	140,0	115,0	133,0	105,0	134,0	134,0	20
22	143,0	143,0	113,0	75,0	132,0	134,5	111,0	127,0	101,0	128,5	128,5	22
24	137,0	137,0	108,0	73,0	127,0	129,0	107,0	121,0	97,5	123,0	123,0	24
26	122,0	131,0	104,0	71,0	119,5	124,0	103,0	116,0	94,0	114,5	118,0	26
28	110,0	126,0	101,0	69,0	112,0	119,0	100,0	111,0	90,5	106,0	113,0	28
30	100,0	121,0	98,0	67,5	102,0	115,0	97,0	107,0	87,5	96,5	109,0	30
34	84,3	112,3	92,0	64,5	84,7	107,5	91,3	99,7	82,5	79,5	101,2	34
38	70,8	104,8	86,6	61,6	71,8	100,6	86,1	93,5	77,8	66,5	94,5	38
42	59,5	98,5	82,0	59,0	60,5	94,0	81,5	87,5	73,5	55,5	88,5	42
46	51,5	92,8	78,0	57,0	52,3	88,6	77,5	82,5	69,8	47,2	83,8	46
50	44,3	87,6	74,3	55,0	45,0	83,6	73,6	78,0	66,5	39,9	79,5	50
54	38,1	83,0	71,0	53,0	38,7	79,0	70,0	74,0	63,5	33,6	75,5	54
58	33,7	79,3	68,3	51,6	34,2	75,6	67,3	70,6	61,1	29,2	71,8	58
62	29,4	75,8	65,8	50,4	29,9	72,5	64,8	67,5	59,0	24,9	68,6	62
66	25,3	72,5	63,5	49,2	25,8	69,5	62,5	64,5	57,0	20,8	66,0	66
70	21,9	69,8	61,5	48,1	22,3	67,1	60,5	62,1	55,0	17,4	63,3	70
74	18,8	67,3	59,6	47,2	19,1	64,8	58,6	60,0	53,3	14,3	61,0	74
78	16,0	65,0	58,0	46,5	16,3	62,5	57,0	58,0	52,0	11,5	59,0	78
82	13,6	63,0	56,6	-	13,9	60,8	55,6	56,3	50,6	9,1	57,3	82
86	11,4	61,3	55,5	-	11,6	59,3	54,5	54,8	49,7	6,8	55,8	86
88	10,4	60,6	55,0	-	10,6	58,6	54,0	54,1	49,5	5,8	55,1	88
90	9,4	60,0	-	-	9,6	58,0	-	53,5	-	4,8	54,5	90
91	9,0	59,5	-	-	9,1	57,5	-	53,5	-	4,3	54,1	91
92	-	-	-	-	-	-	-	-	-	3,9	53,7	92
94	-	-	-	-	-	-	-	-	-	-	53,0	94

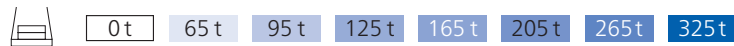

225 t		12 m x 12 m										9.8 m/s		360°		ISO	
		96 m															
		LSL+LF_2		LSL+LF_3		LSL+LF_4		LSL+LF_6		LSL+LF_8		LSL+LF_10					
		12 m															
		0 t		0t-325t		0 t		0t-325t		0 t		0t-325t					
		15°		20°		30°		15°		20°		15°		20°		15°	
m	t	t	t	t	t	t	t	t	t	t	t	t	t	t	t	t	m
14	157,0	162,0	-	-	-	-	-	-	-	158,0	-	178,0	178,0	-	178,0	-	14
15	157,0	161,5	132,0	-	143,0	149,0	127,0	-	-	153,5	118,0	177,0	177,0	-	177,0	-	15
16	157,0	161,0	129,0	-	142,0	147,0	125,0	-	-	149,0	115,0	176,0	176,0	129,0	176,0	129,0	16
17	156,5	160,5	126,5	81,0	141,0	145,5	123,5	-	-	145,5	113,0	171,5	171,5	126,5	171,5	126,5	17
18	156,0	160,0	124,0	80,0	140,0	144,0	122,0	-	-	142,0	111,0	167,0	167,0	124,0	167,0	124,0	18
20	153,0	153,0	119,0	77,5	137,0	140,0	117,0	-	-	135,0	106,0	160,0	160,0	120,0	160,0	120,0	20
22	146,0	146,0	114,0	75,5	132,5	135,5	113,0	-	-	129,5	102,0	146,5	153,0	116,0	153,0	116,0	22
24	136,0	140,0	110,0	73,5	128,0	131,0	109,0	-	-	124,0	99,0	133,0	146,0	112,0	146,0	112,0	24
26	122,0	134,0	106,0	71,5	119,0	126,5	105,0	-	-	119,0	95,5	119,5	140,5	108,0	140,5	108,0	26
28	109,0	129,0	103,0	70,0	110,0	122,0	102,0	-	-	114,0	92,5	106,0	135,0	105,0	135,0	105,0	28
30	99,5	124,0	100,0	68,0	100,2	118,0	99,0	-	-	110,0	89,5	96,5	130,0	101,0	130,0	101,0	30
34	83,5	115,3	94,0	65,3	83,0	110,5	93,6	-	-	102,5	84,5	79,5	121,0	95,6	121,0	95,6	34
38	69,8	107,6	88,6	62,6	69,8	103,8	88,6	-	-	96,0	79,8	66,5	113,3	90,8	113,3	90,8	38
42	58,5	101,0	84,0	60,0	58,5	97,5	84,0	-	-	90,0	75,5	55,5	106,0	86,5	106,0	86,5	42
46	50,5	95,6	80,0	58,0	50,3	92,1	79,6	-	-	85,0	71,8	47,4	100,6	82,5	100,6	82,5	46
50	43,4	90,6	76,3	56,0	43,0	87,1	75,8	-	-	80,5	68,5	40,2	95,5	78,8	95,5	78,8	50
54	37,1	86,0	73,0	54,0	36,7	82,5	72,5	-	-	76,5	65,5	33,9	90,5	75,5	90,5	75,5	54
58	32,7	82,0	70,3	52,3	32,2	78,5	69,5	-	-	73,1	62,8	29,5	86,5	72,5	86,5	72,5	58
62	28,4	78,3	67,6	51,0	27,9	75,0	66,8	-	-	70,0	60,5	25,2	82,8	69,8	82,8	69,8	62
66	24,3	75,0	65,0	50,0	23,7	72,0	64,5	-	-	67,0	58,5	21,2	79,5	67,5	79,5	67,5	66
70	20,9	72,3	63,0	48,9	20,3	69,5	62,5	-	-	64,3	56,5	17,8	76,5	65,5	76,5	65,5	70
74	17,8	69,6	61,1	47,9	17,1	67,3	60,6	-	-	62,0	54,6	14,6	73,6	63,6	73,6	63,6	74
78	15,0	67,0	59,5	47,1	14,3	65,0	59,0	-	-	60,0	53,0	11,8	71,0	62,0	71,0	62,0	78
82	12,6	65,0	57,8	46,4	11,8	62,8	57,3	-	-	58,0	52,0	9,4	69,0	60,6	69,0	60,6	82
86	10,3	63,1	56,5	-	9,5	61,1	56,0	-	-	56,4	50,9	7,2	67,1	59,3	67,1	59,4	86
90	8,3	61,5	55,5	-	7,5	59,5	55,0	-	-	55,0	49,9	5,2	65,5	58,0	65,5	58,0	90
93	7,0	60,5	55,0	-	6,1	58,5	54,0	-	-	54,2	49,3	3,8	64,5	57,5	64,4	57,5	93
94	6,5	60,1	-	-	5,7	58,1	-	-	-	54,0	-	-	64,1	-	64,1	-	94
96	5,7	59,5	-	-	4,8	57,5	-	-	-	53,5	-	-	63,5	-	63,5	-	96



225 t		12 m x 12 m		9.8 m/s		360°		ISO															
99 m																							
LSL+LF_2				LSL+LF_3				LSL+LF_4				LSL+LF_6				LSL+LF_8				LSL+LF_10			
12 m																							
0 t				0 t-325 t				0 t				0 t-325 t				0 t				0 t-325 t			
15°				20°		30°		15°		20°		15°		20°		15°		20°		15°		20°	
m	t	t	t	t	t	t	t	t	t	t	t	t	t	t	t	t	t	t	t	m			
15	-	-	-	-	-	-	-	-	-	154,0	154,0	-	178,0	178,0	-	178,0	-	178,0	-	15			
16	-	-	-	-	-	-	-	-	-	151,0	151,0	116,0	177,0	177,0	130,0	177,0	130,0	177,0	130,0	16			
18	-	-	-	-	-	-	-	-	-	143,0	143,0	111,0	169,0	169,0	125,0	169,0	125,0	169,0	125,0	18			
20	-	-	-	-	-	-	-	-	-	137,0	137,0	107,0	161,0	161,0	121,0	161,0	121,0	161,0	121,0	20			
22	-	-	-	-	-	-	-	-	-	131,0	131,0	103,0	146,0	154,5	116,0	154,5	116,0	154,5	116,0	22			
24	-	-	-	-	-	-	-	-	-	125,0	125,0	100,0	131,0	148,0	112,0	148,0	112,0	148,0	112,0	24			
26	-	-	-	-	-	-	-	-	-	114,5	120,5	96,5	118,0	142,0	109,0	142,0	109,0	142,0	109,0	26			
28	-	-	-	-	-	-	-	-	-	104,0	116,0	93,5	105,0	136,0	105,0	136,0	105,0	136,0	105,0	28			
30	-	-	-	-	-	-	-	-	-	94,5	111,5	90,5	95,5	131,5	102,0	131,5	102,0	131,5	102,0	30			
34	-	-	-	-	-	-	-	-	-	77,5	103,5	85,1	78,5	122,5	96,6	122,5	96,6	122,5	96,6	34			
38	-	-	-	-	-	-	-	-	-	64,3	97,1	80,3	65,5	114,6	91,6	114,6	91,6	114,6	91,6	38			
42	-	-	-	-	-	-	-	-	-	53,0	91,5	76,0	54,5	108,0	87,0	108,0	87,0	108,0	87,0	42			
46	-	-	-	-	-	-	-	-	-	45,0	86,5	72,6	46,3	102,3	83,3	102,3	83,3	102,3	83,3	46			
50	-	-	-	-	-	-	-	-	-	37,8	81,8	69,5	39,0	97,0	79,8	97,0	79,8	97,0	79,8	50			
54	-	-	-	-	-	-	-	-	-	31,5	77,5	66,5	32,7	92,0	76,5	92,0	76,5	92,0	76,5	54			
58	-	-	-	-	-	-	-	-	-	27,1	74,1	63,8	28,3	88,0	73,5	88,0	73,5	88,0	73,5	58			
62	-	-	-	-	-	-	-	-	-	22,8	71,0	61,3	24,0	84,1	70,8	84,1	70,8	84,1	70,8	62			
66	-	-	-	-	-	-	-	-	-	18,7	68,0	59,0	19,9	80,5	68,5	80,5	68,5	80,5	68,5	66			
70	-	-	-	-	-	-	-	-	-	15,3	65,3	57,3	16,5	77,5	66,5	77,5	66,5	77,5	66,5	70			
74	-	-	-	-	-	-	-	-	-	12,1	63,0	55,6	13,4	74,8	64,5	74,8	64,5	74,8	64,5	74			
78	-	-	-	-	-	-	-	-	-	9,3	61,0	54,0	10,6	72,5	62,5	72,5	62,5	72,5	62,5	78			
82	-	-	-	-	-	-	-	-	-	6,9	59,0	52,6	8,2	70,1	61,1	70,1	61,1	70,1	61,1	82			
86	-	-	-	-	-	-	-	-	-	4,6	57,3	51,3	5,9	68,1	59,9	68,0	60,0	68,0	60,0	86			
88	-	-	-	-	-	-	-	-	-	3,6	56,5	50,6	4,9	67,3	59,3	67,1	59,2	67,1	59,2	88			
90	-	-	-	-	-	-	-	-	-	-	55,5	50,0	3,9	66,5	58,5	66,5	58,5	66,5	58,5	90			
94	-	-	-	-	-	-	-	-	-	-	54,5	49,5	-	64,8	57,9	64,8	57,8	64,8	57,8	94			
96	-	-	-	-	-	-	-	-	-	-	54,0	49,2	-	64,0	57,5	64,0	57,5	64,0	57,5	96			
98	-	-	-	-	-	-	-	-	-	-	53,3	-	-	63,3	-	63,0	-	63,0	-	98			
99	-	-	-	-	-	-	-	-	-	-	53,0	-	-	63,0	-	62,5	-	62,5	-	99			



225 t		12 m x 12 m						9.8 m/s				360°		ISO			
		102 m															
		LSL+LF_2		LSL+LF_3		LSL+LF_4		LSL+LF_6		LSL+LF_8		LSL+LF_10					
		12 m															
		0 t		0t-325t		0 t		0t-325t		0 t		0t-325t					
		15°		20°		30°		15°		20°		15°		20°			
m	t	t	t	t	t	t	t	t	t	t	t	t	t	t	t	m	
15	147,0	152,0	-	-	-	-	-	148,0	-	156,0	-	178,0	178,0	-	178,0	-	15
16	147,0	151,0	130,0	-	139,0	143,0	124,0	147,0	127,0	152,0	117,0	178,0	178,0	131,0	178,0	131,0	16
18	147,0	151,0	125,0	80,5	137,0	141,0	122,0	144,0	122,0	144,0	112,0	170,0	170,0	126,0	170,0	126,0	18
20	147,0	150,0	120,0	78,0	136,0	138,0	119,0	141,0	118,0	138,0	108,0	162,0	162,0	121,0	162,0	121,0	20
22	142,0	148,0	116,0	76,0	131,5	134,5	115,0	137,0	114,0	132,0	104,0	146,0	155,5	117,0	155,5	117,0	22
24	132,0	143,0	112,0	74,0	128,0	131,0	111,0	133,0	111,0	126,0	100,0	130,0	149,0	113,0	149,0	113,0	24
26	120,0	137,0	108,0	72,5	118,0	127,5	107,0	128,5	107,0	121,5	97,0	117,0	143,5	110,0	143,5	110,0	26
28	108,0	132,0	105,0	70,5	108,0	124,0	104,0	124,0	104,0	117,0	94,0	104,0	138,0	106,0	138,0	106,0	28
30	97,5	127,0	102,0	69,0	98,5	120,0	101,0	120,5	100,0	113,0	91,0	94,2	133,0	103,0	133,0	103,0	30
34	81,5	118,3	96,0	66,0	81,2	113,0	95,6	113,5	95,3	105,0	86,0	77,2	124,0	97,6	124,0	97,6	34
38	67,8	110,6	90,6	63,3	68,0	106,6	90,6	106,6	90,6	98,1	81,3	64,3	116,3	92,6	116,3	92,6	38
42	56,5	104,0	86,0	61,0	57,0	100,0	86,0	100,0	86,0	92,5	77,0	53,0	109,0	88,0	109,0	88,0	42
46	48,5	98,6	82,0	58,6	48,6	94,6	82,0	94,6	81,6	87,5	73,3	44,9	103,6	84,3	103,6	84,3	46
50	41,4	93,5	78,3	56,6	41,3	89,6	78,1	89,6	77,8	83,0	70,0	37,7	98,5	80,8	98,5	80,8	50
54	35,1	88,5	75,0	55,0	34,9	85,0	74,5	85,0	74,5	79,0	67,0	31,4	93,5	77,5	93,5	77,5	54
58	30,1	84,5	72,0	53,3	29,8	81,0	71,5	81,0	71,5	75,3	64,3	26,4	89,5	74,5	89,5	74,5	58
62	25,8	80,8	69,3	51,8	25,5	77,3	68,8	77,3	68,6	72,0	62,0	22,1	85,6	71,8	85,6	71,8	62
66	22,3	77,5	67,0	50,5	22,0	74,0	66,5	74,0	66,0	69,0	60,0	18,6	82,0	69,5	82,0	69,5	66
70	18,9	74,5	64,6	49,5	18,5	71,6	64,3	71,6	64,3	66,3	58,0	15,2	79,0	67,1	79,0	67,1	70
74	15,7	71,8	62,6	48,6	15,3	69,3	62,1	69,3	62,1	64,0	56,1	12,0	76,1	65,1	76,1	65,1	74
78	12,9	69,5	61,0	47,7	12,4	67,0	60,5	67,0	60,5	62,0	54,5	9,2	73,5	63,5	73,5	63,5	78
82	10,5	67,1	59,3	46,9	10,0	65,0	58,8	65,0	58,8	60,0	53,1	6,8	71,1	61,8	71,1	61,8	82
86	8,2	65,1	57,8	46,3	7,7	63,0	57,3	63,0	57,3	58,1	52,0	4,5	69,0	60,5	69,0	60,5	86
87	7,7	64,7	57,5	46,1	7,2	62,5	57,0	62,5	57,0	57,7	51,6	4,0	68,5	60,2	68,5	60,1	87
88	7,2	64,3	57,1	-	6,6	62,0	56,6	62,0	56,6	57,3	51,2	3,5	68,0	60,0	68,0	59,7	88
90	6,2	63,5	56,5	-	5,6	61,0	56,0	61,0	56,0	56,5	50,5	-	67,0	59,0	67,0	59,0	90
94	4,4	61,8	55,7	-	3,8	59,5	55,0	59,8	55,1	55,1	49,9	-	65,3	58,0	65,6	58,0	94
96	3,6	61,0	55,0	-	-	59,0	54,5	59,0	54,5	54,5	49,6	-	64,5	57,5	65,0	57,5	96
98	-	59,1	54,5	-	-	57,6	54,0	57,1	54,0	53,3	49,2	-	62,8	57,5	62,8	57,5	98
102	-	55,5	-	-	-	55,0	-	53,5	-	51,0	-	-	59,5	-	58,5	-	102



225 t		12 m x 12 m		9.8 m/s		360°		ISO																			
105 m																											
LSL+LF_2				LSL+LF_3				LSL+LF_4				LSL+LF_6				LSL+LF_8				LSL+LF_10							
12 m																											
0 t				0 t-325 t				0 t				0 t-325 t				0 t				0 t-325 t							
15°				20°				30°				15°				20°				15°				20°			
m	t	t	t	t	t	t	t	t	t	t	t	t	t	t	t	t	t	t	t	m							
15	-	-	-	-	-	-	-	141,0	146,0	-	156,0	-	176,0	178,0	-	178,0	-	15									
16	-	-	-	-	-	-	-	140,0	144,0	126,0	153,0	117,0	176,0	178,0	131,0	178,0	131,0	16									
18	-	-	-	-	-	-	-	139,0	142,0	122,0	146,0	113,0	171,0	171,0	126,0	171,0	126,0	18									
20	-	-	-	-	-	-	-	137,0	140,0	119,0	139,0	108,0	164,0	164,0	122,0	164,0	122,0	20									
22	-	-	-	-	-	-	-	131,5	136,5	115,0	133,5	105,0	146,5	157,5	118,0	157,5	118,0	22									
24	-	-	-	-	-	-	-	127,0	133,0	112,0	128,0	101,0	129,0	151,0	114,0	151,0	114,0	24									
26	-	-	-	-	-	-	-	116,0	129,0	108,0	123,0	98,0	116,0	145,0	110,0	145,0	110,0	26									
28	-	-	-	-	-	-	-	105,0	125,0	105,0	118,0	95,0	103,0	139,0	107,0	139,0	107,0	28									
30	-	-	-	-	-	-	-	95,2	121,5	101,0	114,0	92,0	93,2	134,5	104,0	134,5	104,0	30									
34	-	-	-	-	-	-	-	78,0	114,5	96,3	106,5	87,0	76,0	125,5	98,6	125,5	98,6	34									
38	-	-	-	-	-	-	-	65,0	108,0	91,6	100,0	82,3	63,0	117,6	93,6	117,6	93,6	38									
42	-	-	-	-	-	-	-	54,0	102,0	87,0	94,0	78,0	52,0	111,0	89,0	111,0	89,0	42									
46	-	-	-	-	-	-	-	45,8	96,3	82,6	89,0	74,3	43,8	105,0	85,0	105,0	85,0	46									
50	-	-	-	-	-	-	-	38,5	91,1	78,8	84,3	71,0	36,5	99,6	81,3	99,6	81,3	50									
54	-	-	-	-	-	-	-	32,2	86,5	75,5	80,0	68,0	30,2	95,0	78,0	95,0	78,0	54									
58	-	-	-	-	-	-	-	27,1	82,1	72,5	76,3	65,3	25,2	90,6	75,3	90,6	75,3	58									
62	-	-	-	-	-	-	-	22,8	78,3	69,6	73,0	62,8	20,9	86,6	72,6	86,6	72,6	62									
66	-	-	-	-	-	-	-	19,3	75,0	67,0	70,0	60,5	17,4	83,0	70,0	83,0	70,0	66									
70	-	-	-	-	-	-	-	15,9	72,6	65,0	67,3	58,5	14,0	80,0	68,0	80,0	68,0	70									
74	-	-	-	-	-	-	-	12,7	70,5	63,1	64,8	56,6	10,8	77,1	66,0	77,1	66,0	74									
78	-	-	-	-	-	-	-	9,9	68,5	61,5	62,5	55,0	8,0	74,5	64,0	74,5	64,0	78									
82	-	-	-	-	-	-	-	7,5	66,1	59,8	60,5	53,8	5,5	72,1	62,4	72,1	62,5	82									
85	-	-	-	-	-	-	-	5,7	64,5	58,6	59,1	52,6	3,8	70,5	61,5	70,5	61,2	85									
86	-	-	-	-	-	-	-	5,2	64,0	58,2	58,8	52,3	-	70,0	61,2	70,0	61,0	86									
89	-	-	-	-	-	-	-	3,6	62,5	57,2	57,8	51,3	-	68,5	60,3	68,5	60,2	89									
90	-	-	-	-	-	-	-	-	62,0	57,0	57,5	51,0	-	68,0	60,0	68,0	60,0	90									
94	-	-	-	-	-	-	-	-	60,0	55,6	55,8	50,3	-	65,6	58,6	66,0	58,6	94									
98	-	-	-	-	-	-	-	-	57,3	54,5	53,8	49,6	-	62,8	57,6	63,1	57,6	98									
101	-	-	-	-	-	-	-	-	54,8	53,0	52,0	49,1	-	60,3	57,0	60,4	57,0	101									
102	-	-	-	-	-	-	-	-	54,0	-	51,5	-	-	59,5	-	59,5	-	102									
104	-	-	-	-	-	-	-	-	51,0	-	48,6	-	-	57,0	-	56,0	-	104									



225 t		12 m x 12 m										9.8 m/s		360°		ISO	
		108 m															
		LSL+LF_2		LSL+LF_3		LSL+LF_4		LSL+LF_6		LSL+LF_8		LSL+LF_10					
		12 m															
		0 t		0t-325t		0 t		0t-325t		0 t		0t-325t					
		15°		20°		30°		15°		20°		15°		20°			
m	t	t	t	t	t	t	t	t	t	t	t	t	t	t	t	t	m
15	137,0	142,0	-	-	-	-	-	143,0	-	153,0	-	171,0	176,0	-	178,0	-	15
16	137,0	142,0	131,0	-	135,0	139,0	121,0	142,0	125,0	153,0	118,0	171,0	176,0	-	178,0	-	16
17	137,0	142,0	128,5	-	134,5	138,0	120,0	141,0	123,5	150,0	115,5	171,0	174,5	129,0	175,5	129,0	17
18	137,0	142,0	126,0	81,0	134,0	137,0	119,0	140,0	122,0	147,0	113,0	171,0	173,0	127,0	173,0	127,0	18
20	137,0	142,0	122,0	78,5	133,0	136,0	118,0	139,0	119,0	140,0	109,0	161,0	165,0	123,0	165,0	123,0	20
22	136,0	141,0	118,0	76,5	128,5	133,5	115,0	136,0	116,0	134,5	105,0	145,0	158,5	119,0	158,5	119,0	22
24	127,0	140,0	114,0	75,0	126,0	131,0	112,0	133,0	113,0	129,0	102,0	129,0	152,0	115,0	152,0	115,0	24
26	116,0	140,0	110,0	73,0	115,5	127,5	109,0	129,5	109,0	124,0	98,5	115,5	146,5	111,0	146,5	111,0	26
28	105,0	135,0	107,0	71,5	105,0	125,0	106,0	126,0	106,0	119,0	95,5	102,0	141,0	108,0	141,0	108,0	28
30	95,0	130,0	103,0	69,5	96,0	122,0	103,0	122,5	103,0	115,0	93,0	92,2	136,0	105,0	136,0	105,0	30
34	79,0	121,3	97,6	66,8	79,5	115,5	97,6	115,5	97,6	107,5	87,6	75,2	127,0	99,6	127,0	99,6	34
38	65,5	113,6	92,6	64,1	66,3	109,0	92,6	109,0	92,6	101,0	82,8	62,3	119,3	94,6	119,3	94,6	38
42	54,5	107,0	88,0	61,5	55,0	103,0	88,0	103,0	88,0	95,0	78,5	51,0	112,0	90,0	112,0	90,0	42
46	46,3	101,3	84,0	59,5	46,6	97,6	84,0	97,6	84,0	90,0	75,1	42,8	106,0	86,0	106,0	86,0	46
50	39,0	96,1	80,1	57,6	39,3	92,5	80,1	92,5	80,1	85,3	71,8	35,6	100,6	82,3	100,6	82,3	50
54	32,7	91,5	76,5	56,0	32,9	87,5	76,5	87,5	76,5	81,0	68,5	29,3	96,0	79,0	96,0	79,0	54
58	27,7	87,1	73,8	54,3	27,8	83,5	73,5	83,5	73,5	77,3	65,8	24,3	92,0	76,0	92,0	76,0	58
62	23,4	83,3	71,1	52,8	23,5	79,8	70,6	79,8	70,6	74,0	63,5	20,0	88,1	73,3	88,1	73,3	62
66	19,9	80,0	68,5	51,5	19,9	76,5	68,0	76,5	68,0	71,0	61,5	16,5	84,5	71,0	84,5	71,0	66
70	16,5	77,0	66,1	50,3	16,4	73,8	66,0	73,8	66,0	68,3	59,5	13,1	81,1	68,6	81,1	68,6	70
74	13,3	74,1	64,1	49,3	13,2	71,5	64,1	71,5	64,0	65,8	57,6	9,9	78,1	66,6	78,1	66,6	74
78	10,5	71,5	62,5	48,3	10,3	69,5	62,5	69,5	62,0	63,5	56,0	7,1	75,5	65,0	75,5	65,0	78
82	8,0	69,1	60,8	47,5	7,9	67,5	60,8	67,5	60,6	61,5	54,5	4,6	73,1	63,4	73,3	63,4	82
83	7,4	68,5	60,4	47,3	7,3	67,0	60,4	67,0	60,3	61,0	54,0	4,0	72,5	63,0	72,6	63,0	83
86	5,7	67,0	59,3	46,7	5,6	65,5	59,0	65,5	59,0	59,6	52,8	-	71,0	61,8	71,0	61,8	86
89	4,2	65,5	58,3	46,3	4,0	64,0	58,0	64,0	57,8	58,4	51,8	-	69,5	60,8	69,5	60,8	89
90	3,7	65,0	58,0	46,1	-	63,5	57,5	63,5	57,5	58,0	51,5	-	69,0	60,5	69,0	60,5	90
91	-	64,5	57,6	46,0	-	62,9	57,2	62,8	57,2	57,6	51,2	-	68,3	60,1	68,3	60,1	91
94	-	63,0	56,6	-	-	61,1	56,5	60,8	56,5	56,6	50,5	-	66,3	59,1	66,3	59,1	94
98	-	60,0	55,5	-	-	58,6	55,5	57,8	55,3	54,5	49,7	-	63,0	58,1	63,1	58,1	98
102	-	56,0	54,5	-	-	56,0	54,5	54,5	54,0	51,5	49,2	-	59,0	57,5	59,5	57,5	102
103	-	54,7	54,5	-	-	54,6	54,0	53,1	53,5	50,2	49,1	-	57,9	57,0	58,1	57,0	103
106	-	50,8	-	-	-	50,6	-	49,2	-	46,3	-	-	54,6	-	53,9	-	106
107	-	49,5	-	-	-	49,3	-	47,9	-	45,4	-	-	53,5	-	52,5	-	107



225 t		12 m x 12 m										9.8 m/s		360°		ISO	
		111 m															
		LSL+LF_2		LSL+LF_3		LSL+LF_4		LSL+LF_6		LSL+LF_8		LSL+LF_10					
		12 m															
		0 t		0 t-325 t		0 t		0 t-325 t		0 t		0 t-325 t					
		15°		20°		30°		15°		20°		15°		20°		15°	
m	t	t	t	t	t	t	t	t	t	t	t	t	t	t	t	t	m
16	-	-	-	-	-	-	140,0	-	150,0	-	166,0	171,0	-	177,0	-	16	
17	-	-	-	-	135,0	139,0	118,0	139,0	122,0	149,0	116,0	166,0	171,0	130,0	175,5	130,0	17
18	-	-	-	-	135,0	139,0	118,0	138,0	121,0	148,0	114,0	166,0	171,0	127,0	174,0	127,0	18
20	-	-	-	-	135,0	138,0	117,0	137,0	119,0	141,0	110,0	158,0	166,0	123,0	166,0	123,0	20
22	-	-	-	-	128,0	136,0	115,0	134,5	117,0	135,5	106,0	142,5	159,5	119,0	159,5	119,0	22
24	-	-	-	-	124,0	134,0	113,0	132,0	113,0	130,0	102,0	127,0	153,0	115,0	153,0	115,0	24
26	-	-	-	-	113,5	131,5	110,0	129,0	110,0	125,0	99,5	114,0	147,5	112,0	147,5	112,0	26
28	-	-	-	-	103,0	129,0	107,0	126,0	107,0	120,0	96,5	101,0	142,0	109,0	142,0	109,0	28
30	-	-	-	-	94,5	126,5	104,0	123,0	104,0	116,0	93,5	91,2	137,5	106,0	137,5	106,0	30
34	-	-	-	-	78,2	121,0	98,6	117,0	98,6	108,5	88,5	74,0	128,5	100,3	128,5	100,3	34
38	-	-	-	-	64,8	114,6	93,6	111,0	93,6	102,0	83,8	61,0	120,6	95,3	120,6	95,3	38
42	-	-	-	-	53,5	108,0	89,0	105,0	89,0	96,0	79,5	50,0	114,0	91,0	114,0	91,0	42
46	-	-	-	-	45,3	102,3	85,0	99,3	85,0	91,0	75,8	41,7	108,0	87,0	108,0	87,0	46
50	-	-	-	-	38,1	97,0	81,1	94,1	81,1	86,3	72,5	34,4	102,5	83,3	102,5	83,3	50
54	-	-	-	-	31,7	92,0	77,5	89,5	77,5	82,0	69,5	28,1	97,5	80,0	97,5	80,0	54
58	-	-	-	-	26,5	87,6	74,5	85,1	74,5	78,3	66,8	23,0	93,1	77,0	93,1	77,0	58
62	-	-	-	-	21,9	83,6	71,6	81,3	71,6	75,0	64,3	18,7	89,1	74,1	89,1	74,1	62
66	-	-	-	-	17,8	80,0	69,0	78,0	69,0	72,0	62,0	15,2	85,5	71,5	85,5	71,5	66
70	-	-	-	-	14,8	77,0	67,0	75,0	66,6	69,3	60,0	11,8	82,5	69,5	82,5	69,5	70
74	-	-	-	-	11,9	74,5	65,1	72,5	64,6	66,8	58,1	8,6	79,5	67,5	79,5	67,5	74
78	-	-	-	-	9,1	72,5	63,5	70,5	63,0	64,5	56,5	5,8	76,5	65,5	76,5	65,5	78
81	-	-	-	-	7,2	70,7	62,2	69,0	62,0	63,0	55,2	3,9	75,0	64,3	74,8	64,2	81
82	-	-	-	-	6,6	70,1	61,8	68,5	61,6	62,5	54,8	-	74,3	64,0	74,2	63,8	82
86	-	-	-	-	4,2	68,0	60,0	66,5	60,1	60,6	53,5	-	72,0	62,3	72,0	62,3	86
87	-	-	-	-	3,7	67,5	59,5	66,0	59,7	60,2	53,2	-	71,5	62,0	71,5	62,0	87
90	-	-	-	-	-	65,0	58,5	64,5	58,5	59,0	52,5	-	70,0	61,0	70,0	61,0	90
94	-	-	-	-	-	62,3	57,1	62,1	57,1	57,3	51,1	-	66,3	59,6	66,0	59,6	94
98	-	-	-	-	-	59,1	56,0	58,8	55,8	54,8	50,2	-	62,6	58,5	62,1	58,5	98
102	-	-	-	-	-	55,5	55,0	54,5	54,5	51,5	49,6	-	59,0	57,5	58,5	57,5	102
106	-	-	-	-	-	50,5	50,5	49,4	49,7	46,5	46,9	-	54,6	55,5	53,8	54,5	106
109	-	-	-	-	-	46,8	-	45,6	-	42,9	-	-	51,0	-	50,0	-	109

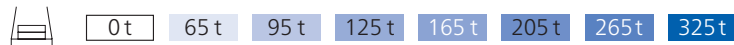

225 t		12 m x 12 m										9.8 m/s		360°		ISO											
114 m																											
LSL+LF_2				LSL+LF_3				LSL+LF_4				LSL+LF_6				LSL+LF_8				LSL+LF_10				LSL+LF_12			
12 m																											
0 t		0 t - 325 t				0 t		0 t - 325 t				0 t		0 t - 325 t				0 t		0 t - 325 t							
15°		20°		30°		15°		20°		15°		20°		15°		20°		15°		20°		15°		20°			
m	t	t	t	t	t	t	t	t	t	t	t	t	t	t	t	t	t	t	t	t	t	t	t	t	m		
16	127,0	132,0	-	-	-	-	-	137,0	-	147,0	-	160,0	165,0	-	170,0	-	175,0	-	16								
17	127,0	132,0	124,0	-	130,0	135,0	116,0	137,0	119,0	147,0	116,0	160,0	165,0	130,0	170,0	130,0	175,0	130,0	17								
18	127,0	132,0	124,0	-	130,0	135,0	116,0	137,0	119,0	147,0	114,0	160,0	165,0	128,0	170,0	128,0	175,0	128,0	18								
19	127,0	131,5	123,5	80,0	130,0	135,0	115,5	136,5	118,5	144,5	112,0	156,0	165,0	126,0	169,0	126,0	171,5	126,0	19								
20	127,0	131,0	123,0	79,0	130,0	135,0	115,0	136,0	118,0	142,0	110,0	155,0	165,0	124,0	168,0	124,0	168,0	124,0	20								
22	127,0	131,0	119,0	77,0	123,5	133,5	114,0	135,0	117,0	136,5	107,0	141,0	160,0	120,0	161,5	120,0	161,5	120,0	22								
24	122,0	130,0	115,0	75,5	120,0	132,0	112,0	134,0	114,0	131,0	103,0	127,0	155,0	116,0	155,0	116,0	155,0	116,0	24								
26	112,0	130,0	111,0	73,5	110,0	130,0	110,0	131,5	111,0	126,5	100,0	113,5	149,5	113,0	149,5	113,0	149,5	113,0	26								
28	103,0	129,0	108,0	72,0	102,0	128,0	107,0	129,0	108,0	122,0	97,0	100,0	144,0	109,0	144,0	109,0	144,0	109,0	28								
30	93,5	128,0	105,0	70,5	93,7	125,5	104,0	127,0	105,0	117,5	94,0	90,5	139,0	106,0	139,0	106,0	139,0	106,0	30								
34	77,5	122,6	99,3	67,5	77,7	120,0	98,6	122,0	99,3	109,5	89,0	73,5	130,0	101,0	130,0	101,0	130,0	101,0	34								
38	63,8	116,6	94,1	64,8	64,3	113,6	93,6	116,0	94,3	103,1	84,5	60,5	122,3	96,1	122,3	96,1	122,3	96,1	38								
42	52,5	110,0	89,5	62,5	53,0	107,0	89,0	110,0	90,0	97,5	80,5	49,6	115,0	91,5	115,0	91,5	115,0	91,5	42								
46	44,3	104,0	85,5	60,5	44,8	101,0	84,6	104,0	86,0	92,1	76,8	41,3	109,0	87,5	109,0	87,5	109,0	87,5	46								
50	37,0	98,6	81,8	58,5	37,5	95,1	80,6	98,6	82,1	87,5	73,3	34,0	103,6	83,8	103,6	83,8	103,6	83,8	50								
54	30,7	94,0	78,5	56,5	31,1	89,5	77,0	94,0	78,5	83,5	70,0	27,7	99,0	80,5	99,0	80,5	99,0	80,5	54								
58	25,6	89,6	75,5	54,8	26,0	84,8	73,6	89,6	75,5	79,8	67,3	22,6	94,6	77,8	94,6	77,8	94,6	77,8	58								
62	21,0	85,6	72,6	53,3	21,4	79,0	70,6	85,1	72,6	76,3	64,8	18,0	90,3	75,1	90,6	75,1	90,6	75,1	62								
66	17,0	82,0	70,0	52,0	17,2	73,5	68,0	81,5	70,0	73,0	62,5	14,0	87,0	72,5	87,0	72,5	87,0	72,5	66								
70	14,1	79,0	67,6	51,0	14,3	70,5	66,0	78,5	67,6	70,3	60,5	11,1	83,6	70,1	83,6	70,1	83,6	70,1	70								
74	11,2	76,1	65,5	50,0	11,4	67,0	64,1	75,8	65,6	67,8	58,7	8,2	80,0	68,0	80,6	68,0	80,6	68,0	74								
78	8,4	73,5	63,5	49,0	8,5	64,5	62,5	73,5	64,0	65,5	57,0	5,4	77,0	66,0	78,0	66,0	78,0	66,0	78								
80	7,1	72,3	62,6	48,5	7,2	64,0	61,1	72,5	63,3	64,5	56,3	4,1	75,5	65,5	76,4	65,5	76,6	65,1	80								
82	5,9	71,1	61,8	48,0	6,0	63,5	60,3	71,5	62,6	63,5	55,6	-	74,0	64,5	75,2	64,5	75,3	64,3	82								
86	3,6	69,0	60,6	47,3	3,7	62,0	59,2	69,3	61,1	61,5	54,3	-	70,6	62,8	72,8	62,8	72,5	62,8	86								
90	-	66,0	59,0	46,6	-	60,0	58,0	67,0	59,5	59,5	53,0	-	67,0	61,5	70,5	61,5	69,5	61,5	90								
94	-	62,6	57,6	46,0	-	57,6	56,3	63,0	57,8	58,1	51,6	-	63,6	60,1	66,1	60,1	65,1	60,1	94								
96	-	61,0	57,0	45,3	-	56,5	55,5	61,0	57,0	57,5	51,0	-	62,0	59,5	64,0	59,5	63,0	59,5	96								
98	-	59,1	56,1	-	-	55,3	54,8	59,0	56,0	55,5	50,6	-	60,3	58,5	62,0	58,6	61,0	58,8	98								
102	-	55,5	54,5	-	-	53,0	53,5	55,0	54,0	51,5	50,0	-	57,0	56,5	58,0	57,0	57,0	57,5	102								
106	-	51,0	50,8	-	-	50,2	50,2	50,2	50,0	46,8	47,0	-	53,3	53,8	54,3	54,3	53,3	53,8	106								
108	-	48,8	49,0	-	-	48,8	48,6	47,9	48,1	44,3	44,6	-	51,5	52,5	52,5	53,0	51,5	52,0	108								
110	-	46,3	-	-	-	46,3	-	45,4	-	41,8	-	-	49,8	-	50,0	-	48,8	-	110								
112	-	43,9	-	-	-	43,9	-	43,0	-	40,0	-	-	48,1	-	47,5	-	46,2	-	112								



225 t		12 m x 12 m										9.8 m/s		360°		ISO											
117 m																											
LSL+LF_2				LSL+LF_3				LSL+LF_4				LSL+LF_6				LSL+LF_8				LSL+LF_10				LSL+LF_12			
12 m																											
0 t				0 t - 325 t				0 t				0 t - 325 t				0 t				0 t - 325 t							
15°				20°				30°				15°				20°				15°				20°			
m	t	t	t	t	t	t	t	t	t	t	t	t	t	t	t	t	t	t	t	m							
16	-	-	-	-	-	-	-	133,0	-	144,0	-	155,0	160,0	-	165,0	-	170,0	-	17,0	16							
17	-	-	-	-	126,0	131,0	114,0	133,0	117,0	144,0	117,0	155,0	160,0	131,0	164,5	131,0	170,0	131,0	17,0	17							
18	-	-	-	-	126,0	131,0	114,0	133,0	117,0	144,0	115,0	155,0	160,0	129,0	164,0	129,0	170,0	129,0	18,0	18							
20	-	-	-	-	126,0	131,0	114,0	133,0	116,0	143,0	111,0	152,0	160,0	124,0	164,0	124,0	169,0	124,0	20,0	20							
22	-	-	-	-	121,0	130,5	113,0	132,5	116,0	137,5	107,0	138,0	158,0	120,0	160,0	120,0	162,5	120,0	22,0	22							
24	-	-	-	-	119,0	130,0	112,0	132,0	114,0	132,0	104,0	125,0	156,0	117,0	156,0	117,0	156,0	117,0	24,0	24							
26	-	-	-	-	109,0	128,5	110,0	130,5	111,0	127,5	100,0	112,2	150,5	113,0	150,5	113,0	150,5	113,0	26,0	26							
28	-	-	-	-	100,0	127,0	108,0	129,0	108,0	123,0	97,5	99,5	145,0	110,0	145,0	110,0	145,0	110,0	28,0	28							
30	-	-	-	-	92,0	125,5	105,0	127,0	105,0	118,5	95,0	89,7	140,0	107,0	140,0	107,0	140,0	107,0	30,0	30							
34	-	-	-	-	76,5	121,5	100,0	123,0	100,0	110,5	90,0	72,5	131,0	102,0	131,0	102,0	131,0	102,0	34,0	34							
38	-	-	-	-	63,3	115,6	95,1	118,0	95,3	104,1	85,3	59,4	123,3	97,1	123,3	97,1	123,3	97,1	38,0	38							
42	-	-	-	-	52,0	109,0	90,5	112,0	91,0	98,5	81,0	48,4	116,0	92,5	116,0	92,5	116,0	92,5	42,0	42							
46	-	-	-	-	43,7	103,6	86,1	106,6	87,0	93,5	77,3	40,1	110,0	88,5	110,0	88,5	110,0	88,5	46,0	46							
50	-	-	-	-	36,3	98,3	82,0	100,8	83,3	88,8	74,0	32,8	104,6	84,8	104,6	84,8	104,6	84,8	50,0	50							
54	-	-	-	-	29,9	93,0	78,0	96,0	80,0	84,5	71,0	26,4	100,0	81,5	100,0	81,5	100,0	81,5	54,0	54							
58	-	-	-	-	24,7	86,3	75,0	91,3	76,6	80,8	68,3	21,4	95,6	78,5	95,6	78,5	95,6	78,5	58,0	58							
62	-	-	-	-	20,1	82,1	72,0	87,1	73,6	77,3	65,8	16,8	91,6	75,6	91,6	75,6	91,6	75,6	62,0	62							
66	-	-	-	-	16,0	78,5	69,0	83,5	71,0	74,0	63,5	12,7	88,0	73,0	88,0	73,0	88,0	73,0	66,0	66							
70	-	-	-	-	13,0	73,3	67,0	80,1	68,6	71,3	61,5	9,8	84,6	71,0	84,6	71,0	84,6	71,0	70,0	70							
74	-	-	-	-	10,1	70,8	65,0	77,1	66,6	68,7	59,5	6,9	81,6	69,0	81,6	69,0	81,6	69,0	74,0	74							
78	-	-	-	-	7,2	68,5	63,0	74,5	65,0	66,0	57,5	4,1	79,0	67,0	79,0	67,0	79,0	67,0	78,0	78							
82	-	-	-	-	4,7	66,1	61,8	72,5	63,5	64,0	56,1	-	76,3	65,3	76,3	65,3	76,3	65,3	82,0	82							
84	-	-	-	-	3,5	65,5	61,0	71,5	62,5	63,0	55,5	-	75,0	64,5	75,0	64,5	75,0	64,5	84,0	84							
86	-	-	-	-	-	64,5	60,1	69,8	61,8	62,1	54,8	-	73,3	63,6	73,1	63,6	72,8	63,6	86,0	86							
90	-	-	-	-	-	62,5	58,5	66,5	60,5	60,5	53,5	-	70,0	62,0	69,5	62,0	68,5	62,0	90,0	90							
94	-	-	-	-	-	59,5	56,5	62,1	58,3	58,5	52,1	-	65,6	60,3	65,1	60,6	64,1	60,6	94,0	94							
98	-	-	-	-	-	56,6	54,6	58,1	56,0	55,3	51,0	-	61,5	58,1	61,0	58,6	60,0	58,8	98,0	98							
102	-	-	-	-	-	54,0	53,0	54,5	53,0	51,0	50,0	-	57,5	55,5	57,0	56,0	56,0	56,5	102,0	102							
106	-	-	-	-	-	50,3	49,9	49,8	49,6	46,5	46,4	-	53,8	52,5	53,4	53,0	52,6	52,6	106,0	106							
110	-	-	-	-	-	46,1	46,0	44,3	45,6	41,8	42,0	-	49,9	49,9	49,7	49,9	48,6	49,0	110,0	110							
111	-	-	-	-	-	45,0	44,9	42,8	44,5	40,7	40,9	-	48,8	49,4	48,5	49,2	47,4	48,0	111,0	111							
114	-	-	-	-	-	41,5	-	40,2	-	37,9	-	-	45,7	-	45,1	-	43,8	-	114,0	114							
115	-	-	-	-	-	40,4	-	39,0	-	36,8	-	-	44,4	-	43,8	-	42,5	-	115,0	115							



225 t		12 m x 12 m										9.8 m/s		360°		ISO											
120 m																											
LSL+LF_2				LSL+LF_3				LSL+LF_4				LSL+LF_6				LSL+LF_8				LSL+LF_10				LSL+LF_12			
12 m																											
0 t		0 t - 325 t				0 t		0 t - 325 t				0 t		0 t - 325 t				0 t									
15°		20°		30°		15°		20°		15°		20°		15°		20°		15°		20°							
m	t	t	t	t	t	t	t	t	t	t	t	t	t	t	t	t	t	t	t	m							
16	113,0	117,0	-	-	-	-	-	127,0	-	138,0	-	-	-	-	-	-	-	-	-	16							
17	113,0	116,5	112,0	-	121,0	125,0	113,0	127,0	114,0	138,0	115,0	149,0	154,0	129,0	158,0	129,0	164,0	129,0	18								
18	113,0	116,0	112,0	-	121,0	125,0	113,0	127,0	114,0	138,0	113,0	147,0	154,0	127,0	158,0	127,0	164,0	127,0	19								
19	112,5	116,0	112,0	80,5	121,0	125,0	113,0	127,0	114,0	138,0	111,0	147,0	154,0	125,0	158,0	125,0	164,0	125,0	20								
20	112,0	116,0	112,0	79,5	121,0	125,0	113,0	127,0	114,0	138,0	110,0	147,0	154,0	125,0	158,0	125,0	164,0	125,0	20								
22	112,0	115,0	112,0	77,5	117,0	125,0	113,0	127,0	114,0	135,5	108,0	134,0	153,5	121,0	157,5	121,0	160,5	121,0	22								
24	112,0	115,0	111,0	76,0	115,0	125,0	112,0	127,0	113,0	133,0	104,0	123,0	153,0	117,0	157,0	117,0	157,0	117,0	24								
26	108,0	114,0	111,0	74,0	105,5	123,0	109,0	127,0	110,0	128,5	101,0	111,0	149,5	114,0	151,5	114,0	151,5	114,0	26								
28	100,0	113,0	110,0	72,5	98,5	121,0	107,0	127,0	108,0	124,0	98,5	99,0	146,0	111,0	146,0	111,0	146,0	111,0	28								
30	92,0	113,0	106,0	71,0	90,7	119,0	104,0	126,0	106,0	120,0	95,5	89,0	141,5	108,0	141,5	108,0	141,5	108,0	30								
34	76,0	111,6	101,0	68,3	75,5	114,5	99,3	124,0	101,0	112,0	90,5	71,5	132,5	102,6	132,5	102,6	132,5	102,6	34								
38	62,5	109,6	96,1	65,6	62,3	108,6	94,8	120,0	96,5	105,1	85,8	58,5	124,6	97,6	124,6	97,6	124,6	97,6	38								
42	51,5	107,0	91,5	63,0	51,0	102,0	90,5	114,0	92,5	99,5	81,5	47,6	118,0	93,0	118,0	93,0	118,0	93,0	42								
46	43,2	104,3	87,1	61,0	42,8	96,3	86,1	108,6	88,5	94,5	78,1	39,2	112,0	89,3	112,0	89,3	112,0	89,3	46								
50	35,9	100,3	83,3	59,1	35,5	91,0	82,1	102,6	84,6	89,8	74,8	31,9	106,3	85,6	106,3	85,6	106,3	85,6	50								
54	29,5	96,0	80,0	57,5	29,1	86,0	78,5	98,0	81,0	85,5	71,5	25,5	101,0	82,0	101,0	82,0	101,0	82,0	54								
58	24,4	92,0	77,0	55,8	23,9	81,3	74,8	93,1	78,0	81,8	68,8	20,5	96,6	79,3	96,6	79,3	96,6	79,3	58								
62	19,8	87,8	74,1	54,3	19,3	76,1	71,5	89,1	75,0	78,3	66,3	15,9	92,6	76,6	92,6	76,6	92,6	76,6	62								
66	15,8	84,5	71,5	53,0	15,2	70,5	68,5	85,5	72,0	75,0	64,0	11,8	89,0	74,0	89,0	74,0	89,0	74,0	66								
70	12,9	80,5	69,1	51,6	12,2	67,5	64,1	82,0	70,0	72,3	62,0	8,9	85,6	71,6	85,6	71,6	85,6	71,6	70								
74	10,0	77,6	67,0	50,5	9,3	64,5	61,5	79,1	67,6	69,6	60,0	6,0	82,6	69,5	82,6	69,5	82,6	69,5	74								
77	7,9	75,6	65,5	49,8	7,1	62,2	60,0	77,1	66,4	67,6	58,8	3,9	80,5	68,0	80,5	68,0	80,6	68,0	77								
78	7,2	75,0	65,0	49,6	6,4	61,5	59,5	76,5	66,0	67,0	58,5	-	80,0	67,5	80,0	67,5	80,0	67,5	78								
82	4,7	72,2	63,5	48,6	3,8	59,7	57,2	73,7	64,2	65,0	56,8	-	77,3	65,8	77,3	65,8	77,0	65,8	82								
83	4,1	71,5	63,0	48,4	-	59,3	56,8	73,1	63,8	64,5	56,4	-	76,6	65,4	76,6	65,4	76,2	65,4	83								
86	-	69,1	61,6	47,8	-	58,0	56,0	70,1	62,6	63,0	55,3	-	73,8	64,1	73,6	64,1	73,0	64,1	86								
90	-	65,5	60,0	47,1	-	57,0	55,0	65,5	61,0	61,0	54,0	-	69,5	62,5	69,0	62,5	68,0	62,5	90								
94	-	62,1	58,6	46,4	-	54,6	54,0	61,1	59,3	58,0	52,6	-	64,8	60,5	64,3	60,8	63,6	61,5	94								
98	-	58,6	56,6	45,9	-	52,3	52,5	56,6	56,0	54,7	51,1	-	60,6	58,0	60,1	58,5	59,5	59,1	98								
100	-	56,8	55,3	45,7	-	51,1	51,5	54,3	53,5	52,9	50,3	-	58,8	56,5	58,3	57,0	57,5	57,3	100								
102	-	55,0	54,0	-	-	50,0	50,5	52,0	51,0	50,5	49,2	-	57,0	55,0	56,5	55,5	55,5	55,5	102								
106	-	51,3	51,1	-	-	48,0	48,7	45,5	45,3	46,1	45,8	-	53,4	52,2	52,6	52,5	52,1	52,1	106								
110	-	47,2	47,4	-	-	45,7	46,1	40,6	41,2	41,7	41,9	-	49,7	49,0	49,1	49,4	48,4	48,6	110								
113	-	43,9	44,1	-	-	42,9	42,8	35,9	37,4	38,4	38,6	-	47,0	46,9	46,4	47,0	45,3	45,8	113								
114	-	42,8	-	-	-	41,8	-	34,9	-	37,3	-	-	46,1	-	45,5	-	44,3	-	114								
117	-	39,5	-	-	-	38,5	-	31,1	-	34,4	-	-	42,5	-	41,9	-	40,6	-	117								

	0t	65t	95t	125t	165t	205t	265t	325t
--	----	-----	-----	------	------	------	------	------

225 t		12 m x 12 m										9.8 m/s		360°		ISO											
123 m																											
LSL+LF_2				LSL+LF_3				LSL+LF_4				LSL+LF_6				LSL+LF_8				LSL+LF_10				LSL+LF_12			
12 m																											
0 t				0 t - 325 t				0 t				0 t - 325 t				0 t				0 t - 325 t							
15°				20°				30°				15°				20°				15°				20°			
m	t	t	t	t	t	t	t	t	t	t	t	t	t	t	t	t	t	t	t	m							
17	-	-	-	-	-	-	-	122,0	-	133,0	-	144,0	148,0	-	153,0	-	159,0	-	17								
18	-	-	-	-	116,0	120,0	111,0	122,0	112,0	133,0	116,0	144,0	148,0	130,0	153,0	130,0	159,0	130,0	18								
20	-	-	-	-	116,0	120,0	111,0	122,0	112,0	133,0	112,0	143,0	148,0	125,0	153,0	125,0	159,0	125,0	20								
22	-	-	-	-	113,5	120,0	111,0	122,0	112,0	133,0	108,0	130,5	147,5	122,0	152,5	122,0	158,5	122,0	22								
24	-	-	-	-	113,0	120,0	111,0	122,0	112,0	133,0	105,0	121,0	147,0	118,0	152,0	118,0	158,0	118,0	24								
26	-	-	-	-	103,5	119,5	109,0	121,5	110,0	129,0	102,0	109,2	147,0	115,0	149,5	115,0	152,5	115,0	26								
28	-	-	-	-	96,5	119,0	106,0	121,0	108,0	125,0	99,0	97,5	147,0	112,0	147,0	112,0	147,0	112,0	28								
30	-	-	-	-	88,7	117,5	104,0	121,0	106,0	121,0	96,0	87,7	142,5	109,0	142,5	109,0	142,5	109,0	30								
34	-	-	-	-	74,0	115,0	100,3	120,5	102,0	113,5	91,0	70,5	134,0	103,6	134,0	103,6	134,0	103,6	34								
38	-	-	-	-	61,3	111,0	96,1	117,6	97,8	106,6	86,5	57,4	126,3	98,6	126,3	98,6	126,3	98,6	38								
42	-	-	-	-	50,0	105,0	91,5	113,0	93,5	100,0	82,5	46,4	119,0	94,0	119,0	94,0	119,0	94,0	42								
46	-	-	-	-	41,7	100,0	87,5	109,0	89,8	95,3	78,8	38,0	113,0	90,0	113,0	90,0	113,0	90,0	46								
50	-	-	-	-	34,3	95,0	83,6	104,6	86,1	90,8	75,5	30,7	107,3	86,3	107,3	86,3	107,3	86,3	50								
54	-	-	-	-	27,9	90,0	80,0	100,0	82,5	86,5	72,5	24,3	102,0	83,0	102,0	83,0	102,0	83,0	54								
58	-	-	-	-	22,7	83,6	76,6	95,5	79,5	82,8	69,8	19,2	98,0	80,0	98,0	80,0	98,0	80,0	58								
62	-	-	-	-	18,1	78,1	73,1	91,0	76,5	79,3	67,1	14,6	94,0	77,1	94,0	77,1	94,0	77,1	62								
66	-	-	-	-	13,9	74,5	69,5	87,0	73,5	76,0	64,5	10,6	90,0	74,5	90,0	74,5	90,0	74,5	66								
70	-	-	-	-	10,5	70,1	67,1	83,3	71,1	73,0	62,5	7,7	86,6	72,5	86,6	72,5	86,6	72,5	70								
74	-	-	-	-	7,5	67,1	64,2	79,6	69,0	70,4	60,6	4,7	83,6	70,2	83,5	70,1	83,4	70,5	74								
75	-	-	-	-	6,9	66,5	63,3	78,7	68,5	69,8	60,2	4,0	83,0	69,6	82,8	69,6	82,8	70,0	75								
78	-	-	-	-	5,1	64,5	61,5	76,0	67,0	68,0	59,0	-	81,0	68,5	81,0	68,5	81,0	68,5	78								
80	-	-	-	-	3,8	63,1	60,6	74,1	65,9	66,8	58,1	-	79,3	67,5	79,1	67,5	78,8	67,5	80								
82	-	-	-	-	-	62,3	59,8	72,3	64,7	65,6	57,3	-	77,6	66,5	77,3	66,5	76,6	66,5	82								
86	-	-	-	-	-	60,5	58,1	67,6	61,8	63,6	55,8	-	73,5	64,8	73,0	64,8	72,0	64,8	86								
90	-	-	-	-	-	59,0	57,5	62,0	58,5	62,0	54,5	-	68,5	63,5	68,0	63,5	67,0	63,5	90								
94	-	-	-	-	-	56,6	55,5	55,3	54,8	57,6	53,1	-	63,8	61,1	63,3	61,5	62,6	61,5	94								
98	-	-	-	-	-	54,1	53,3	49,7	50,6	53,5	51,8	-	59,6	58,3	59,1	58,8	58,5	58,5	98								
102	-	-	-	-	-	51,5	51,0	44,3	47,0	50,0	49,1	-	56,0	55,0	55,5	55,5	54,5	54,5	102								
106	-	-	-	-	-	48,7	49,0	38,3	40,7	45,6	45,4	-	52,2	51,5	51,8	51,8	51,1	51,2	106								
110	-	-	-	-	-	45,4	45,5	33,5	35,6	41,2	41,4	-	49,0	48,3	48,4	48,4	47,7	47,8	110								
114	-	-	-	-	-	41,5	41,3	29,1	29,7	37,0	37,2	-	46,0	45,1	45,3	45,3	44,0	44,4	114								
116	-	-	-	-	-	39,3	39,2	26,5	27,7	34,9	35,1	-	43,6	43,4	43,0	43,3	41,7	42,0	116								
118	-	-	-	-	-	37,2	-	23,9	-	33,2	-	-	41,3	-	40,6	-	39,4	-	118								
120	-	-	-	-	-	35,3	-	21,3	-	31,0	-	-	39,0	-	38,3	-	37,1	-	120								



225 t		12 m x 12 m																9.8 m/s		360°		ISO									
126 m																															
LSL+LF_2				LSL+LF_3				LSL+LF_4				LSL+LF_6				LSL+LF_8				LSL+LF_10				LSL+LF_12				LSL+LF_14			
12 m																															
0 t				0t-325t				0 t				0t-325t				0 t				0t-325t											
15°				20°				30°				15°				20°				15°				20°							
m	t	t	t	t	t	t	t	t	t	t	t	t	t	t	t	t	t	t	t	t	t	t	t	t	t	t	t	m			
17	98,5	101,0	-	-	-	-	-	110,0	-	124,0	-	134,0	137,0	-	142,0	-	156,0	-	171,0	-	17										
18	98,5	101,0	99,0	-	105,0	109,0	106,0	110,0	106,0	124,0	116,0	134,0	137,0	130,0	142,0	130,0	156,0	130,0	156,0	126,0	170,0	127,0	18								
20	98,5	100,0	98,5	80,0	105,0	109,0	106,0	110,0	106,0	124,0	112,0	134,0	137,0	126,0	142,0	126,0	156,0	126,0	170,0	123,0	20										
22	98,0	100,0	98,0	78,0	105,0	108,5	106,0	109,5	106,0	124,0	109,0	125,0	137,0	122,0	142,0	122,0	155,5	122,0	163,0	119,0	22										
24	98,0	100,0	98,0	76,0	105,0	108,0	106,0	109,0	106,0	124,0	105,0	120,0	137,0	119,0	142,0	119,0	155,0	119,0	157,0	116,0	24										
26	97,0	99,5	97,5	74,5	100,0	108,0	105,0	108,5	105,0	124,0	102,0	109,0	137,0	115,0	142,0	115,0	152,0	115,0	151,5	112,5	26										
28	95,5	99,0	97,0	73,0	97,0	108,0	105,0	108,0	105,0	124,0	99,5	98,0	137,0	112,0	142,0	112,0	149,0	112,0	146,0	109,0	28										
30	90,0	98,0	96,5	71,5	89,5	107,5	104,0	107,5	104,0	121,0	97,0	88,2	136,5	109,0	140,5	109,0	144,0	109,0	141,0	106,0	30										
34	75,0	96,6	95,1	68,8	75,2	106,0	103,3	106,5	102,6	114,5	92,0	71,0	133,5	103,6	135,0	103,6	135,0	103,6	132,0	100,7	34										
38	61,8	95,5	93,3	66,3	62,8	104,0	101,8	104,6	100,8	107,6	87,3	57,9	127,3	98,8	127,3	98,8	127,3	98,8	124,5	96,2	38										
42	50,5	93,5	91,0	64,0	51,5	102,0	99,5	102,0	98,5	101,0	83,0	46,8	120,0	94,5	120,0	94,5	120,0	94,5	117,6	91,8	42										
46	42,3	91,5	88,3	62,0	43,1	100,0	97,5	99,3	94,5	96,3	79,3	38,4	114,0	90,8	114,0	90,8	114,0	90,8	111,0	87,5	46										
50	35,1	89,5	85,1	60,0	35,7	97,6	95,3	96,6	90,6	91,8	76,0	31,1	108,3	87,1	108,3	87,1	108,3	87,1	105,6	84,1	50										
54	28,7	87,5	81,5	58,0	29,3	95,0	93,0	94,0	87,0	87,5	73,0	24,8	103,0	83,5	103,0	83,5	103,0	83,5	100,6	81,0	54										
58	23,6	84,1	78,5	56,3	24,1	91,3	88,3	88,5	83,6	83,5	70,3	19,7	99,0	80,8	99,0	80,8	99,0	80,8	96,0	78,0	58										
62	19,0	81,5	75,6	54,8	19,5	88,6	84,1	84,1	80,6	80,0	67,8	15,1	95,1	78,1	95,1	78,1	95,1	78,1	92,0	75,0	62										
66	15,0	78,5	73,0	53,5	15,4	86,0	81,5	80,5	78,0	77,0	65,5	11,0	91,5	75,5	91,5	75,5	91,5	75,5	88,3	72,3	66										
70	11,6	74,3	70,3	52,1	11,9	81,8	78,1	77,5	74,3	74,0	63,1	7,6	88,1	73,1	88,1	73,1	88,0	73,1	85,0	70,0	70										
74	8,7	71,3	67,3	51,0	9,0	78,6	74,6	73,3	71,3	71,2	61,5	4,8	85,0	71,0	84,8	71,0	85,0	71,0	82,0	68,0	74										
76	7,5	69,6	66,1	50,5	7,8	76,8	73,3	72,1	69,6	70,0	60,5	3,7	83,5	70,0	83,3	70,0	83,5	70,0	80,5	67,0	76										
78	6,3	68,5	65,0	50,0	6,6	75,5	72,0	71,0	68,5	69,0	59,5	-	82,0	69,0	82,0	69,0	82,0	69,0	77,6	66,1	78										
82	3,8	66,0	62,6	49,2	4,0	73,0	69,5	68,3	66,5	66,6	57,8	-	78,3	67,0	78,0	67,0	76,6	67,0	72,0	64,5	82										
86	-	63,5	60,1	48,4	-	70,0	67,3	66,0	64,3	64,5	56,3	-	73,8	65,3	73,5	65,3	71,3	65,3	66,6	62,8	86										
90	-	61,0	57,5	47,6	-	66,0	65,0	64,0	63,0	62,5	55,0	-	68,5	64,0	68,5	64,0	66,0	64,0	61,6	60,7	90										
94	-	58,0	55,5	46,9	-	61,6	61,6	61,0	60,6	58,8	53,6	-	64,1	62,0	63,8	62,0	61,6	61,0	57,0	57,5	94										
98	-	55,1	53,3	46,3	-	57,6	58,0	57,6	57,6	55,1	52,5	-	60,0	59,3	59,6	59,3	57,5	57,5	53,0	53,1	98										
102	-	52,5	51,0	45,8	-	54,0	54,0	54,0	54,0	51,5	51,5	-	56,0	56,0	56,0	56,0	53,5	54,0	49,3	49,3	102										
105	-	50,3	49,3	42,2	-	51,6	51,7	51,5	51,6	48,6	48,7	-	53,5	53,5	53,1	53,1	51,0	51,4	46,7	46,8	105										
106	-	49,5	48,8	-	-	50,8	50,9	50,7	50,8	47,6	47,7	-	52,6	52,6	52,2	52,2	50,2	50,5	45,9	46,0	106										
110	-	46,7	46,5	-	-	47,6	47,5	47,4	47,6	43,6	43,8	-	49,5	49,3	49,1	48,9	47,0	47,2	42,7	42,8	110										
114	-	43,6	43,9	-	-	43,7	43,6	43,3	43,5	39,5	39,7	-	46,6	45,9	46,3	45,8	43,9	44,2	39,6	39,8	114										
118	-	39,6	39,8	-	-	39,7	39,5	39,3	39,5	35,5	35,7	-	42,7	42,5	42,4	42,4	39,4	39,7	36,8	36,9	118										
122	-	35,7	-	-	-	35,7	-	35,3	-	32,1	-	-	38,4	-	37,9	-	35,0	-	34,2	-	122										

	0t	65 t	95 t	125 t	165 t	205 t	265 t	325 t
--	----	------	------	-------	-------	-------	-------	-------

225 t		12 m x 12 m												9.8 m/s		360°		ISO													
129 m																															
LSL+LF_2				LSL+LF_3				LSL+LF_4				LSL+LF_6				LSL+LF_8				LSL+LF_10				LSL+LF_12				LSL+LF_14			
12 m																															
0 t				0 t-325 t				0 t				0 t-325 t				0 t				0 t-325 t											
15°				20°				30°				15°				20°				15°				20°							
m	t	t	t	t	t	t	t	t	t	t	t	t	t	t	t	t	t	t	t	t	t	m									
17	-	-	-	-	-	-	-	105,0	-	118,0	-	129,0	132,0	-	137,0	-	150,0	-	165,0	-	17										
18	-	-	-	-	100,0	104,0	102,0	105,0	102,0	118,0	116,0	129,0	132,0	128,0	137,0	130,0	150,0	130,0	165,0	128,0	18										
20	-	-	-	-	100,0	104,0	102,0	105,0	102,0	118,0	113,0	129,0	132,0	126,0	137,0	126,0	150,0	126,0	165,0	124,0	20										
22	-	-	-	-	100,0	103,5	102,0	104,5	102,0	118,0	109,0	121,5	132,0	123,0	137,0	123,0	150,0	123,0	165,0	120,0	22										
24	-	-	-	-	100,0	103,0	102,0	104,0	102,0	118,0	106,0	118,0	132,0	119,0	137,0	119,0	150,0	119,0	158,0	116,0	24										
26	-	-	-	-	97,2	102,5	102,0	103,5	102,0	117,5	103,0	107,5	131,5	116,0	136,5	116,0	149,0	116,0	152,5	113,0	26										
28	-	-	-	-	95,0	102,0	101,0	103,0	101,0	117,0	100,0	97,0	131,0	113,0	136,0	113,0	148,0	113,0	147,0	110,0	28										
30	-	-	-	-	87,5	101,5	101,0	102,5	101,0	117,0	97,5	87,2	130,5	110,0	136,0	110,0	144,0	110,0	142,5	107,0	30										
34	-	-	-	-	73,7	101,0	100,0	101,5	100,0	114,5	92,5	70,0	129,5	104,6	134,0	104,6	136,0	104,6	133,5	101,5	34										
38	-	-	-	-	61,8	100,1	98,8	100,1	98,5	108,6	88,0	56,8	126,3	99,8	128,3	99,8	128,3	99,8	125,5	96,7	38										
42	-	-	-	-	50,5	98,5	97,5	98,5	96,5	102,0	84,0	45,6	121,0	95,5	121,0	95,5	121,0	95,5	118,6	92,5	42										
46	-	-	-	-	42,0	96,8	95,8	96,8	94,1	97,3	80,3	37,3	115,0	91,5	115,0	91,5	115,0	91,5	112,0	88,5	46										
50	-	-	-	-	34,5	95,1	94,1	95,0	91,1	92,8	76,8	30,0	109,6	87,8	109,6	87,8	109,6	87,8	106,6	84,8	50										
54	-	-	-	-	28,1	93,5	92,5	93,0	87,5	88,5	73,5	23,6	105,0	84,5	105,0	84,5	105,0	84,5	101,6	81,5	54										
58	-	-	-	-	22,9	90,8	89,5	90,1	84,5	84,5	70,8	18,5	100,3	81,5	100,3	81,5	100,3	81,5	97,0	78,5	58										
62	-	-	-	-	18,3	88,3	85,8	87,3	81,5	81,0	68,3	13,9	96,1	78,6	96,1	78,6	96,1	78,6	93,0	75,5	62										
66	-	-	-	-	14,2	86,0	83,5	85,0	78,5	78,0	66,0	9,8	92,5	76,0	92,5	76,0	92,5	76,0	89,3	73,3	66										
70	-	-	-	-	10,7	83,1	79,6	81,3	76,1	75,0	64,0	6,4	89,1	73,6	89,1	73,6	89,1	73,8	86,0	71,0	70										
73	-	-	-	-	8,4	80,9	77,7	78,9	74,4	73,0	62,5	3,9	86,5	72,0	86,7	72,0	86,5	72,0	83,2	69,2	73										
74	-	-	-	-	7,8	80,3	77,0	77,8	73,8	72,3	62,0	-	85,8	71,5	86,0	71,5	85,6	71,5	82,3	68,6	74										
78	-	-	-	-	5,4	78,0	74,5	75,5	71,5	69,5	60,0	-	83,0	69,5	83,0	69,5	82,0	69,5	77,3	66,6	78										
80	-	-	-	-	4,0	77,0	73,5	74,5	70,0	68,5	59,1	-	80,5	68,6	80,3	68,6	79,0	68,6	74,1	65,8	80										
82	-	-	-	-	-	74,5	72,5	73,2	68,7	67,5	58,3	-	78,0	67,8	77,6	67,8	76,0	67,8	71,0	65,0	82										
86	-	-	-	-	-	69,6	69,3	69,5	66,8	65,1	56,8	-	73,0	66,1	72,5	66,1	70,3	66,1	65,5	63,4	86										
90	-	-	-	-	-	65,0	65,0	64,5	64,5	62,5	55,5	-	68,0	64,5	67,5	64,5	65,0	64,5	60,6	60,5	90										
94	-	-	-	-	-	60,6	60,6	60,5	60,5	58,1	54,1	-	63,3	62,5	62,8	62,1	60,6	60,5	56,0	56,5	94										
98	-	-	-	-	-	56,6	56,6	56,6	56,6	54,0	53,0	-	59,1	59,5	58,7	59,0	56,5	56,6	52,0	52,0	98										
102	-	-	-	-	-	53,0	53,0	53,0	53,0	50,5	50,5	-	55,5	55,5	55,0	55,0	52,5	53,0	48,2	48,3	102										
106	-	-	-	-	-	49,7	49,8	49,6	49,8	46,7	46,9	-	51,8	51,8	51,6	51,6	49,2	49,5	44,7	44,9	106										
110	-	-	-	-	-	46,4	46,4	46,2	46,4	42,9	43,1	-	48,5	48,5	48,3	48,4	46,0	46,2	41,4	41,6	110										
114	-	-	-	-	-	43,1	42,9	42,8	43,0	38,9	39,2	-	45,7	45,5	45,3	45,4	43,0	43,2	38,3	38,5	114										
118	-	-	-	-	-	39,2	39,0	38,9	39,1	35,1	35,3	-	42,3	41,8	41,7	41,7	38,9	39,1	35,5	35,6	118										
121	-	-	-	-	-	36,3	36,2	36,1	36,3	32,2	32,4	-	39,3	39,1	38,8	39,0	35,8	36,0	33,5	33,6	121										
122	-	-	-	-	-	35,3	-	35,1	-	31,3	-	-	38,2	-	37,7	-	34,7	-	32,9	-	122										
125	-	-	-	-	-	32,5	-	32,3	-	28,6	-	-	35,1	-	34,6	-	31,6	-	30,9	-	125										



225 t		12 m x 12 m										9.8 m/s		360°		ISO				
		132 m																		
		LSL+LF_2		LSL+LF_3		LSL+LF_4		LSL+LF_6		LSL+LF_8		LSL+LF_10		LSL+LF_12		LSL+LF_14				
		12 m																		
		0 t		0t-325t		0 t		0t-325t		0 t		0t-325t		0 t		0t-325t				
		15°		20°		30°		15°		20°		15°		20°		15°		20°		
m	t	t	t	t	t	t	t	t	t	t	t	t	t	t	t	t	t	t	m	
17	86,0	88,5	-	-	-	-	-	-	-	-	-	-	-	-	-	-	-	-	17	
18	86,0	88,5	86,5	-	96,0	99,5	98,0	100,0	98,0	112,0	109,0	123,0	126,0	-	131,0	-	144,0	-	158,0	18
19	85,7	88,2	86,5	-	96,0	99,5	98,0	100,0	98,0	112,0	109,0	123,0	126,0	123,0	131,0	127,0	144,0	129,0	158,0	19
20	85,5	88,0	86,5	79,5	96,0	99,5	98,0	100,0	98,0	112,0	109,0	123,0	126,0	123,0	131,0	127,0	144,0	127,0	158,0	20
22	85,5	87,5	86,0	78,5	96,0	99,2	97,5	100,0	98,0	112,0	109,0	118,0	126,0	123,0	131,0	123,0	144,0	123,0	158,0	22
24	85,5	87,5	85,5	76,5	96,0	99,0	97,5	100,0	98,0	112,0	106,0	116,0	126,0	120,0	131,0	120,0	144,0	120,0	158,0	24
26	85,0	86,5	85,0	75,0	94,0	98,5	97,0	99,5	97,5	111,5	103,0	106,0	125,5	116,0	130,5	116,0	143,0	116,0	153,0	26
28	84,5	86,0	84,5	73,5	93,5	98,0	96,5	99,0	97,0	111,0	100,0	96,0	125,0	113,0	130,0	113,0	143,0	113,0	148,0	28
30	84,0	85,5	84,0	72,0	86,2	97,5	96,0	98,5	96,5	110,5	98,0	86,2	124,5	110,0	130,0	110,0	142,0	110,0	143,5	30
34	71,6	84,3	83,1	69,3	72,7	96,7	95,0	97,5	95,8	110,0	93,0	69,0	123,5	105,3	129,0	105,3	137,0	105,3	134,5	34
38	60,8	83,1	82,3	66,8	60,9	95,6	93,5	96,1	94,6	107,6	88,5	55,9	122,0	100,6	126,0	100,6	129,3	100,6	126,5	38
42	49,6	81,5	81,0	64,5	49,7	94,0	91,5	94,5	93,0	103,0	84,5	44,8	120,0	96,0	122,0	96,0	122,0	96,0	119,6	42
46	41,2	79,8	79,3	62,5	41,2	92,0	89,5	92,8	91,3	98,3	80,8	36,4	115,3	92,3	116,0	92,3	116,0	92,3	113,0	46
50	33,9	78,3	77,8	60,5	33,7	90,1	87,5	91,1	89,6	93,8	77,5	29,1	110,6	88,6	110,6	88,6	110,6	88,6	107,6	50
54	27,5	77,0	76,5	58,5	27,3	88,5	85,5	89,5	88,0	89,5	74,5	22,7	106,0	85,0	106,0	85,0	106,0	85,0	102,8	54
58	22,4	75,6	74,8	57,1	22,1	85,0	81,5	87,3	84,0	85,5	71,5	17,6	101,6	82,0	101,6	82,0	101,6	82,0	98,5	58
62	17,8	73,1	72,6	55,6	17,5	81,8	78,8	84,5	81,0	81,8	68,8	13,0	97,5	79,3	97,5	79,3	97,5	79,3	94,1	62
66	13,7	71,5	70,0	54,0	13,3	79,0	76,5	82,5	77,5	78,5	66,5	8,9	93,5	77,0	93,5	77,0	93,5	77,0	90,6	66
70	10,3	69,1	67,6	53,0	9,9	76,3	72,6	79,1	75,1	75,8	64,5	5,5	90,1	74,6	89,9	74,6	90,0	74,5	87,0	70
72	8,6	68,0	66,5	52,5	8,2	75,0	71,5	78,0	74,0	74,5	63,5	3,8	88,5	73,5	88,5	73,5	88,5	73,5	84,5	72
74	7,4	66,6	64,5	51,8	6,9	72,8	70,1	76,4	71,8	73,1	62,5	-	86,8	72,3	86,8	72,3	86,0	72,3	82,0	74
78	5,1	65,0	62,5	50,5	4,5	70,5	66,5	73,5	69,5	70,5	60,5	-	83,5	70,0	83,5	70,0	81,0	70,0	76,5	78
79	4,4	64,1	62,0	50,5	3,8	69,5	66,0	73,0	68,7	69,9	60,0	-	82,0	69,5	82,0	69,5	79,5	69,5	75,0	79
80	3,8	63,5	61,5	50,2	-	68,9	65,5	72,5	68,0	69,3	59,6	-	80,6	69,1	80,5	69,1	78,0	69,1	73,5	80
82	-	62,5	60,5	49,7	-	67,7	64,5	71,5	67,0	68,1	58,8	-	77,8	68,3	77,5	68,3	75,0	68,3	70,5	82
86	-	60,6	58,0	48,9	-	65,3	62,1	68,3	65,0	65,1	57,3	-	72,3	66,6	71,8	66,6	69,5	66,6	64,8	86
90	-	59,0	56,0	48,1	-	63,0	60,5	64,0	63,0	61,5	56,0	-	67,0	65,0	66,5	65,0	64,5	65,0	60,1	90
94	-	56,6	53,6	47,3	-	59,3	57,8	59,6	59,3	57,1	54,6	-	62,6	62,0	62,1	62,0	60,0	60,2	55,5	94
98	-	54,0	51,4	46,7	-	55,6	55,0	55,6	55,6	53,5	53,5	-	58,5	58,5	58,0	58,5	56,0	56,0	51,1	98
102	-	51,0	49,3	46,1	-	52,0	52,0	52,0	52,0	49,8	50,0	-	54,5	55,0	54,0	54,5	52,0	52,0	47,5	102
106	-	48,4	47,1	45,6	-	48,8	49,0	48,6	48,8	46,0	46,2	-	51,2	51,4	50,8	51,1	48,6	48,8	43,9	106
109	-	46,4	45,4	45,3	-	46,4	46,5	46,2	46,4	43,2	43,4	-	48,8	48,9	48,4	48,6	46,2	46,4	41,4	109
110	-	45,7	44,8	-	-	45,7	45,7	45,4	45,6	42,2	42,4	-	48,0	48,1	47,6	47,8	45,4	45,6	40,6	110
114	-	43,0	42,6	-	-	42,7	42,5	42,3	42,5	38,4	38,6	-	45,0	45,1	44,6	44,7	42,4	42,5	37,5	114
118	-	39,6	39,6	-	-	38,9	38,8	38,6	38,7	34,6	34,8	-	41,8	41,7	41,4	41,4	38,8	39,0	34,7	118
122	-	36,1	36,3	-	-	35,2	35,1	34,9	35,1	31,0	31,2	-	38,3	38,0	37,8	37,8	34,8	35,1	32,0	122
123	-	35,2	35,4	-	-	34,3	34,2	34,0	34,2	30,1	30,3	-	37,3	37,0	36,8	36,9	33,8	34,1	31,4	123
126	-	32,5	-	-	-	31,6	-	31,3	-	27,8	-	-	34,3	-	33,8	-	30,8	-	29,4	126
128	-	30,7	-	-	-	29,9	-	29,6	-	25,8	-	-	32,2	-	31,7	-	28,8	-	28,0	128



225 t		12 m x 12 m										9.8 m/s		360°		ISO															
135 m																															
LSL+LF_2				LSL+LF_3				LSL+LF_4				LSL+LF_6				LSL+LF_8				LSL+LF_10				LSL+LF_12				LSL+LF_14			
12 m																															
0 t				0t-325t				0 t				0t-325t				0 t				0t-325t											
15°				20°				30°				15°				20°				15°				20°							
m	t	t	t	t	t	t	t	t	t	t	t	t	t	t	t	t	t	t	t	t	t	t	t	t	t	t	t	m			
18	-	-	-	-	-	-	-	96,0	-	106,0	-	117,0	120,0	-	125,0	-	138,0	-	151,0	-	18										
19	-	-	-	-	92,0	95,0	94,0	96,0	94,0	106,0	104,0	117,0	120,0	118,0	125,0	122,0	138,0	129,0	151,0	127,0	19										
20	-	-	-	-	92,0	95,0	94,0	96,0	94,0	106,0	104,0	117,0	120,0	118,0	125,0	122,0	138,0	127,0	151,0	125,0	20										
22	-	-	-	-	92,0	95,0	93,5	95,7	94,0	105,5	104,0	114,5	120,0	118,0	125,0	122,0	138,0	124,0	151,0	121,0	22										
24	-	-	-	-	92,0	95,0	93,5	95,5	94,0	105,0	104,0	114,0	120,0	118,0	125,0	120,0	138,0	120,0	151,0	117,0	24										
26	-	-	-	-	90,7	94,5	93,0	95,0	93,5	105,0	103,0	104,5	120,0	117,0	125,0	117,0	137,5	117,0	150,0	114,0	26										
28	-	-	-	-	90,5	94,0	93,0	94,5	93,5	105,0	101,0	95,0	120,0	114,0	125,0	114,0	137,0	114,0	149,0	111,0	28										
30	-	-	-	-	83,7	93,7	92,5	94,2	93,0	104,5	98,5	85,2	119,5	111,0	124,5	111,0	137,0	111,0	144,5	108,0	30										
34	-	-	-	-	71,2	93,0	91,5	93,5	92,3	103,5	93,8	68,0	118,0	105,6	123,0	105,6	135,5	105,6	136,0	102,5	34										
38	-	-	-	-	59,8	92,0	90,5	92,3	91,5	102,3	89,3	54,8	116,3	101,0	121,3	101,0	130,6	101,0	128,0	98,0	38										
42	-	-	-	-	48,5	91,0	89,5	91,0	90,5	101,0	85,0	43,6	115,0	97,0	120,0	97,0	124,0	97,0	120,6	94,0	42										
46	-	-	-	-	40,1	89,3	87,8	89,6	89,1	98,3	81,3	35,2	111,6	93,0	116,0	93,0	118,0	93,0	114,0	90,0	46										
50	-	-	-	-	32,6	87,8	86,3	88,3	87,6	94,8	78,0	27,9	108,3	89,3	111,6	89,3	112,3	89,3	108,6	86,3	50										
54	-	-	-	-	26,1	86,5	85,0	87,0	86,0	90,5	75,0	21,5	105,0	86,0	107,0	86,0	107,0	86,0	103,8	83,0	54										
58	-	-	-	-	20,9	84,3	81,8	85,6	83,8	86,5	72,3	16,3	101,6	83,0	102,3	83,0	102,3	83,0	99,5	80,0	58										
62	-	-	-	-	16,3	82,1	79,3	83,3	81,1	82,8	69,6	11,7	98,1	80,1	98,1	80,1	98,1	80,1	95,5	77,2	62										
66	-	-	-	-	12,1	80,5	76,5	82,0	79,5	79,5	67,0	7,7	94,5	77,5	94,5	77,5	94,5	77,5	91,6	74,6	66										
70	-	-	-	-	8,6	77,1	74,5	78,3	76,0	76,5	65,0	4,2	91,0	75,1	91,0	75,0	91,1	75,2	88,0	72,0	70										
74	-	-	-	-	5,4	75,0	71,0	76,5	74,0	73,8	63,0	-	87,3	73,0	87,1	73,0	86,3	73,0	81,3	70,0	74										
76	-	-	-	-	4,0	73,6	70,0	75,5	73,0	72,6	62,0	-	85,1	72,0	84,8	72,0	83,1	72,0	78,0	69,0	76										
78	-	-	-	-	-	72,0	69,0	74,5	72,0	71,5	61,0	-	83,0	71,0	82,5	71,0	80,0	71,0	75,1	68,0	78										
82	-	-	-	-	-	70,0	66,5	71,5	69,3	69,1	59,3	-	77,0	69,0	76,5	69,0	74,0	69,0	69,5	66,0	82										
86	-	-	-	-	-	67,0	64,5	67,5	66,6	65,5	57,8	-	71,3	67,1	71,0	67,1	68,5	66,6	63,8	63,5	86										
90	-	-	-	-	-	63,0	62,5	62,5	63,0	60,5	56,5	-	66,0	65,5	66,0	65,5	63,5	64,0	58,6	59,1	90										
94	-	-	-	-	-	58,6	58,5	58,5	58,6	56,1	55,1	-	61,6	61,5	61,3	61,5	59,0	59,3	54,0	54,5	94										
98	-	-	-	-	-	54,6	54,6	54,6	54,6	52,2	52,6	-	57,5	57,5	57,0	57,5	55,0	55,0	50,0	50,3	98										
102	-	-	-	-	-	51,0	51,0	51,0	51,0	48,6	48,8	-	53,5	54,0	53,0	53,5	51,0	51,0	46,2	46,4	102										
106	-	-	-	-	-	47,6	47,7	47,6	47,7	45,0	45,2	-	50,2	50,5	49,8	50,1	47,4	47,6	42,6	42,8	106										
110	-	-	-	-	-	44,6	44,7	44,5	44,7	41,3	41,5	-	47,0	47,2	46,6	46,8	44,1	44,3	39,4	39,6	110										
114	-	-	-	-	-	41,6	41,7	41,5	41,7	37,6	37,8	-	44,0	44,2	43,6	43,8	41,0	41,2	36,3	36,5	114										
118	-	-	-	-	-	38,2	38,0	37,9	38,1	34,0	34,2	-	41,2	41,2	40,6	40,9	37,9	38,1	33,4	33,6	118										
122	-	-	-	-	-	34,6	34,5	34,4	34,6	30,4	30,6	-	37,8	37,7	37,3	37,5	34,2	34,5	30,8	30,9	122										
126	-	-	-	-	-	31,2	31,0	30,9	31,1	27,0	27,1	-	33,9	33,6	33,4	33,5	30,4	30,6	28,1	28,4	126										
130	-	-	-	-	-	27,7	-	27,5	-	23,5	-	-	30,1	-	29,5	-	26,5	-	25,4	-	130										



225 t		12 m x 12 m										9.8 m/s		360°		ISO					
138 m																					
LSL+LF_2		LSL+LF_3		LSL+LF_4		LSL+LF_6		LSL+LF_8		LSL+LF_10		LSL+LF_12		LSL+LF_14							
12 m																					
0 t		0t-325t		0 t		0t-325t		0 t		0t-325t		0 t		0t-325t							
15°		20°		30°		15°		20°		15°		20°		15°		20°					
m	t	t	t	t	t	t	t	t	t	t	t	t	t	t	t	t	t	t	m		
18	-	77,0	-	-	-	-	-	89,0	-	97,0	-	111,0	115,0	-	121,0	-	130,0	-	148,0	-	18
19	-	76,7	75,0	-	80,5	82,5	81,0	89,0	89,0	96,7	95,0	111,0	114,5	112,0	121,0	118,0	130,0	127,0	148,0	127,0	19
20	-	76,5	75,0	-	80,5	82,5	81,0	89,0	89,0	96,5	95,0	111,0	114,0	112,0	121,0	118,0	130,0	127,0	148,0	125,0	20
21	-	76,2	74,7	70,0	80,3	82,2	80,7	89,0	89,0	96,3	94,7	110,7	113,7	112,0	121,0	118,0	130,0	125,5	148,0	123,0	21
22	-	76,0	74,5	69,5	80,2	82,0	80,5	89,0	89,0	96,2	94,5	110,5	113,5	112,0	121,0	118,0	130,0	124,0	148,0	121,0	22
24	-	75,5	74,0	69,5	80,0	81,5	80,0	89,0	89,0	96,0	94,5	110,0	113,0	112,0	121,0	118,0	130,0	121,0	148,0	118,0	24
26	-	75,0	73,5	69,0	79,7	81,0	80,0	89,0	89,0	95,5	94,0	101,5	112,5	112,0	120,5	118,0	129,5	118,0	147,5	115,0	26
28	-	74,5	73,0	69,0	79,5	80,5	79,5	89,0	89,0	95,0	93,5	93,0	112,0	111,0	120,0	115,0	129,0	115,0	147,0	112,0	28
30	-	74,0	72,5	68,5	77,5	80,0	78,5	89,0	89,0	94,5	93,0	83,7	112,0	110,0	119,5	112,0	129,0	112,0	144,0	109,0	30
34	-	72,6	71,5	67,8	71,5	79,0	77,5	89,0	89,0	93,5	92,0	67,0	111,0	106,0	118,5	106,6	128,5	106,6	137,0	103,5	34
38	-	71,5	70,3	66,6	60,9	77,8	76,3	89,0	88,8	92,3	89,5	53,9	109,3	101,8	117,3	101,8	127,0	101,8	129,0	98,7	38
42	-	70,5	69,0	65,0	49,9	76,5	75,0	89,0	88,5	91,0	85,5	42,8	108,0	97,5	116,0	97,5	125,0	97,5	122,0	94,5	42
46	-	69,1	67,6	63,0	41,4	75,1	73,6	88,6	87,1	89,3	81,8	34,4	106,0	93,5	112,0	93,5	118,6	93,5	116,0	90,5	46
49	34,8	68,1	66,6	61,5	35,5	74,0	72,6	88,0	86,0	88,0	79,2	28,6	104,3	90,6	109,3	90,6	114,6	90,6	111,5	87,7	49
50	33,2	67,8	66,3	61,1	33,9	73,6	72,3	87,6	85,6	87,6	78,5	27,0	103,6	89,8	108,6	89,8	113,3	89,8	110,0	86,8	50
54	26,8	66,5	65,0	59,5	27,5	72,0	71,0	86,0	84,0	86,0	75,5	20,6	101,0	86,5	106,0	86,5	108,0	86,5	104,6	83,5	54
58	21,7	64,8	63,6	57,8	22,3	70,3	69,3	84,1	80,8	84,3	72,8	15,5	99,3	83,5	102,6	83,5	103,3	83,5	100,0	80,5	58
62	17,1	63,3	62,3	56,1	17,7	68,8	67,8	81,6	78,6	81,6	70,3	10,9	97,5	80,6	99,1	80,6	99,1	80,6	96,3	77,9	62
66	13,0	62,0	61,0	54,5	13,5	67,5	66,5	80,0	76,0	80,0	68,0	6,8	95,5	78,0	95,5	78,0	95,5	78,0	92,5	75,3	66
69	10,4	61,0	60,0	53,7	10,9	65,2	64,2	77,2	74,0	77,2	66,2	4,1	93,0	76,5	93,0	76,5	92,9	76,3	89,5	73,5	69
70	9,6	60,6	59,6	53,5	10,1	64,8	63,8	76,6	73,5	76,6	65,6	-	92,1	75,8	92,1	75,8	92,1	75,7	88,5	73,0	70
74	6,4	58,8	57,7	52,4	6,9	63,0	62,2	74,5	70,5	74,0	63,6	-	87,5	73,5	87,5	73,5	87,0	73,5	81,1	70,6	74
78	3,6	57,0	56,5	51,0	4,0	61,0	60,0	72,0	68,5	72,0	62,0	-	81,5	71,5	81,5	71,5	80,0	71,5	74,3	68,6	78
79	3,7	56,3	55,9	50,8	-	60,6	59,6	71,5	67,6	71,4	61,5	-	80,0	71,0	80,0	71,0	78,6	71,0	72,7	68,2	79
82	-	55,1	54,1	50,2	-	59,6	58,6	70,0	65,8	69,6	60,0	-	75,8	69,5	75,8	69,5	74,6	69,5	68,0	67,0	82
86	-	53,8	52,8	49,3	-	57,3	56,3	66,6	64,0	66,3	58,3	-	70,5	67,6	70,3	67,5	69,3	67,1	62,6	62,9	86
90	-	52,5	51,5	48,3	-	56,0	55,0	62,0	62,0	62,0	57,0	-	65,5	66,0	65,0	65,5	64,0	64,5	57,6	58,1	90
94	-	50,6	49,2	47,4	-	54,1	53,3	57,6	58,0	58,0	55,6	-	61,1	61,3	60,6	60,8	59,5	60,0	53,0	53,5	94
98	-	48,8	47,4	46,7	-	52,6	51,5	53,7	54,0	54,0	53,5	-	57,0	57,0	56,5	56,6	55,5	55,5	49,0	49,3	98
102	-	46,5	45,7	46,1	-	51,0	49,5	50,0	50,0	50,0	50,5	-	53,0	53,0	52,5	53,0	51,5	51,5	45,1	45,4	102
106	-	44,3	43,8	45,5	-	48,4	47,3	46,8	46,9	46,9	47,2	-	49,6	49,7	49,2	49,5	48,1	48,3	41,5	41,8	106
110	-	42,2	42,1	44,8	-	45,6	45,1	43,7	43,9	43,5	43,8	-	46,3	46,5	46,0	46,2	44,8	45,0	38,3	38,5	110
114	-	40,1	40,3	38,7	-	42,8	43,0	40,8	40,9	39,9	40,1	-	43,3	43,5	42,9	43,1	41,7	41,9	35,2	35,4	114
118	-	37,9	38,5	-	-	39,9	39,8	37,4	37,6	36,4	36,6	-	40,5	40,6	40,0	40,2	38,8	39,0	32,4	32,5	118
122	-	35,6	36,2	-	-	36,6	36,5	34,1	34,3	33,0	33,2	-	37,4	37,8	36,8	37,2	35,5	35,8	29,7	29,9	122
126	-	33,2	33,4	-	-	33,3	33,1	30,8	31,0	29,7	29,9	-	33,8	33,8	33,3	33,6	31,9	32,2	27,2	27,4	126
128	-	31,5	31,7	-	-	31,6	31,5	29,1	29,3	28,0	28,2	-	31,9	31,7	31,4	31,6	30,0	30,3	26,0	26,2	128
130	-	29,8	-	-	-	29,9	-	27,4	-	26,4	-	-	30,1	-	29,6	-	28,2	-	24,9	-	130
133	-	27,4	-	-	-	27,7	-	25,6	-	24,3	-	-	27,4	-	26,9	-	25,5	-	23,3	-	133

	0t	65t	95t	125t	165t	205t	265t	325t
--	----	-----	-----	------	------	------	------	------

225 t		12 m x 12 m										9.8 m/s		360°		ISO					
141 m																					
LSL+LF_2		LSL+LF_3		LSL+LF_4		LSL+LF_6		LSL+LF_8		LSL+LF_10		LSL+LF_12		LSL+LF_14							
12 m																					
0 t		0t-325t		0 t		0t-325t		0 t		0t-325t		0 t		0t-325t							
15°		20°		30°		15°		20°		15°		20°		15°		20°					
m	t	t	t	t	t	t	t	t	t	t	t	t	t	t	t	t	t	m			
18	-	-	-	-	-	-	89,0	-	92,5	-	107,0	109,0	-	114,0	-	124,0	-	141,0	-	18	
19	-	-	-	-	77,5	79,5	78,5	89,0	89,0	92,0	90,5	107,0	109,0	-	114,0	-	124,0	-	141,0	-	19
20	-	-	-	-	77,5	79,5	78,0	89,0	89,0	92,0	90,5	107,0	109,0	107,0	114,0	112,0	124,0	121,0	141,0	125,0	20
22	-	-	-	-	77,2	79,0	77,5	89,0	88,5	91,7	90,5	106,5	108,5	107,0	113,5	112,0	124,0	121,0	141,0	122,0	22
24	-	-	-	-	77,0	78,5	77,5	89,0	88,5	91,5	90,0	106,0	108,0	107,0	113,0	111,0	124,0	121,0	141,0	118,0	24
26	-	-	-	-	76,5	78,0	77,0	89,0	88,0	91,2	90,0	97,7	108,0	107,0	112,5	111,0	123,5	118,0	140,5	115,0	26
28	-	-	-	-	76,0	77,5	76,5	89,0	88,0	91,0	89,5	91,5	108,0	106,0	112,0	110,0	123,0	115,0	140,0	112,0	28
30	-	-	-	-	75,0	77,0	76,0	89,0	87,5	90,5	89,0	82,5	107,5	106,0	111,5	110,0	123,0	112,0	139,5	109,5	30
34	-	-	-	-	69,2	76,2	75,0	88,5	86,8	89,5	88,3	66,0	106,5	104,6	110,5	106,0	122,5	106,6	136,5	104,0	34
38	-	-	-	-	59,2	75,3	74,0	87,6	86,1	88,5	87,3	52,8	105,3	102,0	109,3	102,0	121,3	102,0	130,0	99,0	38
42	-	-	-	-	48,8	74,0	73,0	87,0	85,5	87,5	86,0	41,6	104,0	98,0	108,0	98,0	120,0	98,0	123,0	95,0	42
46	-	-	-	-	40,3	72,6	72,0	85,6	84,5	85,8	82,6	33,2	101,3	94,3	105,3	94,3	115,3	94,3	117,0	91,0	46
50	-	-	-	-	32,8	71,5	70,8	84,5	83,3	84,3	79,3	25,8	99,1	90,6	103,0	90,6	110,3	90,6	111,0	87,6	50
54	-	-	-	-	26,4	70,5	69,5	83,5	82,0	83,0	76,0	19,4	97,5	87,0	101,0	87,0	107,0	87,0	105,6	84,3	54
58	-	-	-	-	21,2	69,1	68,1	81,8	80,5	81,6	73,3	14,3	95,5	84,0	99,3	84,0	102,6	84,0	101,0	81,0	58
62	-	-	-	-	16,5	67,8	66,8	80,0	78,5	80,1	70,8	9,7	93,5	81,1	97,5	81,1	99,0	81,3	97,3	78,3	62
66	-	-	-	-	12,4	66,5	65,5	79,0	77,5	78,5	68,5	5,6	91,5	78,5	95,5	78,5	95,0	78,5	92,8	75,8	66
68	-	-	-	-	10,6	65,1	64,3	77,0	75,8	77,0	67,3	3,8	91,0	77,5	94,1	77,5	93,1	77,3	90,1	74,6	68
70	-	-	-	-	8,9	64,3	63,6	76,0	74,1	76,0	66,1	-	89,5	76,3	92,3	76,2	91,3	76,1	87,5	73,5	70
74	-	-	-	-	5,7	62,5	62,0	73,4	72,1	73,3	64,1	-	85,5	74,0	87,1	74,0	86,0	74,0	80,1	71,1	74
77	-	-	-	-	3,5	61,3	60,3	71,6	70,9	71,5	62,9	-	81,7	72,5	82,1	72,5	80,7	72,5	74,8	69,6	77
78	-	-	-	-	-	61,0	60,0	71,0	70,5	71,0	62,5	-	80,5	72,0	80,5	72,0	79,0	72,0	73,2	69,2	78
82	-	-	-	-	-	59,1	58,6	69,0	68,3	68,3	60,8	-	75,1	70,3	74,8	70,3	73,6	70,3	67,0	67,5	82
86	-	-	-	-	-	57,8	56,8	65,6	65,3	65,0	59,1	-	69,8	68,0	69,3	67,8	68,3	67,5	61,6	61,8	86
90	-	-	-	-	-	56,5	55,5	61,0	61,0	61,0	57,5	-	64,5	65,0	64,0	64,5	63,0	63,5	56,3	56,6	90
94	-	-	-	-	-	55,0	53,6	56,6	57,0	56,6	55,8	-	60,0	60,2	59,5	60,0	58,4	58,7	51,5	52,0	94
98	-	-	-	-	-	53,3	52,0	52,5	53,0	52,6	53,1	-	56,0	56,0	55,5	55,5	54,0	54,5	47,6	48,0	98
102	-	-	-	-	-	51,0	50,0	49,1	49,4	49,3	49,5	-	52,0	52,0	51,5	51,5	50,0	50,5	43,9	44,1	102
106	-	-	-	-	-	47,7	47,5	45,8	46,0	45,9	46,1	-	48,5	48,7	48,0	48,3	46,8	47,0	40,3	40,5	106
110	-	-	-	-	-	44,6	44,8	42,6	42,7	42,5	42,7	-	45,2	45,4	44,8	45,0	43,5	43,7	37,0	37,2	110
114	-	-	-	-	-	41,7	41,8	39,7	39,9	39,0	39,2	-	42,1	42,3	41,6	41,8	40,4	40,5	33,9	34,1	114
118	-	-	-	-	-	38,9	38,9	36,5	36,7	35,6	35,8	-	39,2	39,4	38,7	38,9	37,5	37,7	31,1	31,2	118
122	-	-	-	-	-	35,8	35,6	33,4	33,6	32,2	32,4	-	36,2	36,4	35,7	35,9	34,4	34,6	28,4	28,6	122
126	-	-	-	-	-	32,6	32,4	30,2	30,4	29,0	29,2	-	33,2	33,4	32,5	32,9	31,2	31,3	25,9	26,1	126
130	-	-	-	-	-	29,4	29,3	27,0	27,2	25,8	26,0	-	29,6	29,3	29,1	29,1	27,6	27,8	23,6	23,8	130
131	-	-	-	-	-	28,6	28,5	26,2	26,4	25,3	25,2	-	28,7	28,3	28,2	28,2	26,8	27,0	23,0	23,3	131
134	-	-	-	-	-	26,2	-	24,0	-	23,1	-	-	26,1	-	25,6	-	24,1	-	21,3	-	134
135	-	-	-	-	-	25,6	-	23,6	-	22,3	-	-	25,3	-	24,7	-	23,2	-	20,8	-	135

0t
65t
95t
125t
165t
205t
265t
325t

225 t		12 m x 12 m										9.8 m/s		360°		ISO					
144 m																					
LSL+LF_2		LSL+LF_3		LSL+LF_4		LSL+LF_6		LSL+LF_8		LSL+LF_10		LSL+LF_12		LSL+LF_14							
12 m																					
0 t		0t-325t		0 t		0t-325t		0 t		0t-325t		0 t		0t-325t							
15°		20°		30°		15°		20°		15°		20°		15°		20°					
m	t	t	t	t	t	t	t	t	t	t	t	t	t	t	t	t	t	t	m		
19	64,5	67,0	65,5	-	-	-	75,0	86,5	-	89,0	-	101,0	104,0	-	108,0	-	118,0	-	134,0	-	19
20	64,5	66,5	65,0	-	74,5	76,0	74,5	86,5	84,5	89,0	89,0	101,0	103,0	102,0	108,0	106,0	118,0	116,0	134,0	126,0	20
21	64,2	66,2	64,7	61,0	74,3	75,8	74,5	86,3	84,5	89,0	88,7	101,0	103,0	102,0	107,7	106,0	118,0	116,0	134,0	124,0	21
22	64,0	66,0	64,5	61,0	74,2	75,7	74,5	86,2	84,5	89,0	88,5	101,0	103,0	102,0	107,5	106,0	118,0	116,0	134,0	122,0	22
24	64,0	65,5	64,0	60,5	74,0	75,5	74,0	86,0	84,0	89,0	88,5	101,0	103,0	101,0	107,0	106,0	118,0	116,0	134,0	119,0	24
26	63,5	65,0	63,5	60,5	73,5	75,0	73,5	85,7	84,0	89,0	88,5	94,5	102,5	101,0	107,0	106,0	117,5	116,0	133,5	116,0	26
28	63,0	64,5	63,0	60,0	73,5	74,5	73,0	85,5	83,5	89,0	88,0	90,0	102,0	101,0	107,0	105,0	117,0	116,0	133,0	113,0	28
30	62,5	64,0	62,5	59,5	72,5	74,0	72,5	85,0	83,5	89,0	88,0	81,2	102,0	101,0	106,5	105,0	117,0	113,0	133,0	110,0	30
34	61,5	62,6	61,5	58,5	67,0	73,0	71,5	84,2	82,8	88,7	87,0	65,0	101,5	100,3	105,5	104,3	116,0	107,6	132,0	104,5	34
38	55,6	61,5	60,3	57,5	58,3	71,8	70,3	83,5	82,0	88,0	86,1	51,9	100,5	99,5	104,3	102,1	114,6	102,8	129,5	100,0	38
42	47,7	60,5	59,0	56,5	48,0	70,5	69,0	83,0	81,0	87,0	85,5	40,7	99,5	98,5	103,0	98,5	114,0	98,5	124,6	95,8	42
46	39,3	59,1	58,0	55,5	39,5	69,1	67,6	81,6	79,6	85,6	82,8	32,3	97,5	94,8	101,0	94,8	110,0	94,8	118,0	91,5	46
50	31,9	57,8	56,8	54,5	32,0	67,6	66,3	80,3	78,3	84,1	79,8	24,9	95,3	91,3	98,8	91,3	106,3	91,3	112,6	88,1	50
54	25,5	56,5	55,5	53,5	25,5	66,0	65,0	79,0	77,0	82,5	76,5	18,5	93,0	88,0	96,5	88,0	103,0	88,0	107,6	85,0	54
58	20,4	55,1	54,1	52,5	20,3	64,6	63,6	77,1	75,6	80,8	73,8	13,3	91,3	85,0	94,5	85,0	100,0	85,0	102,0	82,0	58
62	15,8	53,8	53,0	51,5	15,7	63,3	62,3	75,5	72,6	79,1	71,3	8,7	89,6	82,1	92,6	82,1	95,5	82,1	98,3	79,0	62
66	11,7	52,5	52,0	50,5	11,5	62,0	61,0	74,0	71,0	77,5	69,0	4,6	88,0	79,5	91,0	79,5	92,5	79,5	93,1	76,3	66
67	10,8	52,2	51,6	50,2	10,6	61,4	60,5	73,6	70,0	77,1	68,5	3,7	87,5	79,0	90,5	79,0	90,6	78,9	91,5	75,7	67
70	8,3	51,5	50,6	49,3	8,0	59,6	59,3	72,5	68,0	76,0	67,0	-	86,3	77,2	89,0	77,2	88,3	77,1	86,5	74,0	70
74	5,1	50,2	49,7	48,3	4,7	58,1	57,2	69,3	65,5	73,3	64,6	-	83,3	74,8	85,1	74,8	84,1	74,8	79,1	72,0	74
75	4,4	49,9	49,4	48,0	4,0	57,7	56,9	68,7	64,7	72,7	64,2	-	82,2	74,2	83,7	74,2	82,7	74,2	77,3	71,5	75
76	3,7	49,6	49,1	47,7	-	57,3	56,6	68,1	64,3	72,1	63,8	-	81,1	73,6	82,3	73,6	81,3	73,6	75,5	71,0	76
78	-	49,1	48,5	47,1	-	56,5	56,0	67,0	63,5	71,0	63,0	-	79,0	72,5	79,5	72,5	78,5	72,5	72,1	70,0	78
82	-	47,3	46,6	45,9	-	54,6	53,6	64,8	61,8	68,3	61,3	-	74,0	70,8	73,8	70,8	72,8	70,8	66,0	66,5	82
86	-	46,1	45,4	44,0	-	52,8	52,1	62,6	59,3	64,8	59,6	-	69,0	68,0	68,5	68,0	67,5	67,5	60,6	61,1	86
90	-	44,9	44,2	42,7	-	51,5	50,5	60,0	58,0	60,5	58,0	-	64,0	64,0	63,5	64,0	62,5	62,5	55,5	56,0	90
94	-	43,2	42,3	41,5	-	50,3	49,3	55,6	53,3	56,1	55,3	-	59,3	59,5	58,7	59,3	57,8	58,2	51,0	51,5	94
98	-	41,8	40,8	40,5	-	48,6	48,0	51,6	52,0	52,1	52,2	-	55,0	55,5	54,5	55,0	53,5	53,9	47,0	47,3	98
102	-	40,2	39,4	39,8	-	47,2	46,1	48,2	48,4	48,3	48,6	-	51,0	51,5	50,5	51,0	49,6	49,9	43,1	43,3	102
106	-	38,4	38,2	39,1	-	45,2	44,0	44,8	45,0	44,9	45,1	-	47,7	47,9	47,2	47,4	46,0	46,3	39,5	39,7	106
110	-	36,8	36,9	38,5	-	43,0	41,9	41,6	41,8	41,5	41,7	-	44,4	44,6	43,9	44,1	42,7	42,9	36,2	36,4	110
114	-	35,3	35,7	37,8	-	40,6	39,9	38,7	38,9	38,1	38,3	-	41,3	41,4	40,8	41,0	39,6	39,8	33,1	33,3	114
118	-	33,7	34,5	37,4	-	38,0	37,7	35,7	35,9	34,7	35,0	-	38,4	38,5	37,9	38,1	36,7	36,9	30,3	30,5	118
122	-	32,1	33,3	-	-	35,2	35,1	32,7	32,9	31,5	31,7	-	35,6	35,8	35,0	35,3	33,7	33,9	27,7	27,8	122
126	-	30,6	32,1	-	-	32,1	32,0	29,6	29,7	28,4	28,6	-	32,8	33,0	32,2	32,5	30,7	30,8	25,2	25,3	126
130	-	29,0	29,9	-	-	29,0	28,9	26,5	26,6	25,3	25,5	-	29,3	29,1	28,8	28,9	27,4	27,6	23,0	23,1	130
133	-	27,4	27,6	-	-	26,7	26,6	24,2	24,4	23,2	23,5	-	26,7	26,2	26,2	26,2	24,9	25,1	21,3	21,8	133
134	-	26,7	-	-	-	25,9	-	23,4	-	22,7	-	-	25,8	-	25,4	-	24,1	-	20,7	-	134
138	-	23,7	-	-	-	23,3	-	21,3	-	20,6	-	-	22,5	-	22,1	-	20,7	-	18,3	-	138

0t
65t
95t
125t
165t
205t
265t
325t

225 t		12 m x 12 m										9.8 m/s		360°		ISO				
147 m																				
LSL+LF_3			LSL+LF_4			LSL+LF_6			LSL+LF_8			LSL+LF_10			LSL+LF_12			LSL+LF_14		
12 m																				
0 t			0 t-325 t						0 t			0 t-325 t								
15°		20°		15°		20°		15°		20°		15°		20°		15°		20°		
m	t	t	t	t	t	t	t	t	t	t	t	t	t	t	t	t	t	t	m	
19	-	-	-	82,5	-	86,0	-	97,0	99,0	-	103,0	-	111,0	-	127,0	-	-	-	19	
20	71,5	73,0	72,0	82,5	81,5	86,0	84,5	97,0	99,0	97,5	103,0	101,0	111,0	110,0	127,0	125,0	-	-	20	
22	71,2	72,7	71,5	82,2	81,0	85,7	84,5	97,0	98,7	97,0	103,0	101,0	111,0	110,0	127,0	123,0	-	-	22	
24	71,0	72,5	71,0	82,0	81,0	85,5	84,0	97,0	98,5	97,0	103,0	101,0	111,0	109,0	127,0	119,0	-	-	24	
26	70,7	72,0	71,0	81,7	80,5	85,0	83,5	91,2	98,2	97,0	102,5	101,0	110,5	109,0	127,0	116,0	-	-	26	
28	70,5	71,5	70,5	81,5	80,5	84,5	83,5	88,0	98,0	96,5	102,0	101,0	110,0	109,0	127,0	113,0	-	-	28	
30	70,0	71,2	70,0	81,2	80,0	84,2	83,0	79,7	97,7	96,5	101,5	100,0	109,5	108,0	126,5	110,5	-	-	30	
34	65,2	70,5	69,0	80,5	79,3	83,5	82,3	64,0	97,0	95,5	101,0	99,3	108,5	106,6	125,5	105,5	-	-	34	
38	56,9	69,5	68,0	79,6	78,6	82,6	81,6	50,8	95,8	94,3	100,3	98,5	107,0	103,8	124,5	100,7	-	-	38	
42	46,9	68,5	67,0	79,0	78,0	82,0	81,0	39,6	94,5	93,0	99,0	97,5	106,0	99,5	122,3	96,5	-	-	42	
46	38,4	67,1	66,0	78,0	77,0	81,0	80,0	31,2	92,5	91,3	96,6	94,8	103,3	95,5	119,0	92,5	-	-	46	
50	30,9	66,0	64,8	77,0	76,0	79,8	78,8	23,7	90,6	89,5	94,1	91,8	100,3	91,8	113,6	88,8	-	-	50	
54	24,4	65,0	63,5	76,0	75,0	78,5	77,5	17,3	89,0	87,5	92,0	88,5	97,0	88,5	108,5	85,5	-	-	54	
58	19,2	63,6	62,5	74,6	73,6	77,1	74,5	12,1	87,0	85,1	90,0	85,5	94,3	85,5	103,0	82,5	-	-	58	
62	14,5	62,3	61,3	73,5	72,5	75,8	71,8	7,5	85,2	82,7	88,2	82,7	91,5	82,7	96,6	79,8	-	-	62	
65	11,3	61,3	60,3	72,7	71,7	74,8	70,0	4,4	84,0	80,6	87,0	80,7	87,8	80,7	91,9	77,8	-	-	65	
66	10,3	61,0	60,0	72,5	71,5	74,5	69,5	-	83,5	80,0	86,5	80,0	87,0	80,0	90,3	77,1	-	-	66	
70	6,8	59,4	59,0	71,0	68,5	73,2	67,5	-	81,8	77,6	83,5	77,6	83,3	77,6	84,0	74,5	-	-	70	
74	3,6	57,6	57,0	68,8	66,1	71,3	65,5	-	78,8	75,5	80,6	75,5	80,1	75,1	77,6	72,5	-	-	74	
78	-	56,0	56,0	66,5	64,5	69,0	63,5	-	75,5	73,5	77,0	73,5	76,5	72,5	71,0	70,5	-	-	78	
82	-	54,6	54,0	64,0	62,1	66,3	61,8	-	71,8	70,5	72,3	70,8	71,5	69,5	65,0	65,5	-	-	82	
86	-	53,0	52,3	61,6	60,6	63,0	60,1	-	67,5	67,0	67,3	67,1	66,2	65,8	59,6	59,8	-	-	86	
90	-	52,0	51,0	59,0	59,0	59,0	58,5	-	62,5	63,0	62,0	62,5	61,0	61,5	54,6	54,8	-	-	90	
94	-	50,4	50,0	54,6	55,0	54,8	55,0	-	58,2	58,2	57,6	57,9	56,3	56,8	49,9	50,0	-	-	94	
98	-	49,3	48,3	50,7	51,1	50,7	51,1	-	54,0	54,0	53,5	53,6	52,0	52,5	45,7	46,0	-	-	98	
102	-	47,8	46,7	47,1	47,3	47,2	47,4	-	50,0	50,0	49,6	49,8	48,3	48,6	41,8	42,1	-	-	102	
106	-	45,4	44,4	43,7	43,9	43,7	44,0	-	46,4	46,7	46,0	46,2	44,7	45,0	38,2	38,5	-	-	106	
110	-	42,6	42,1	40,6	40,8	40,4	40,6	-	43,1	43,4	42,7	42,9	41,4	41,6	34,9	35,2	-	-	110	
114	-	39,7	39,8	37,7	37,9	37,0	37,2	-	40,0	40,2	39,5	39,7	38,3	38,5	31,8	32,1	-	-	114	
118	-	36,7	37,0	34,9	35,1	33,8	34,0	-	37,1	37,3	36,7	36,8	35,4	35,6	29,0	29,2	-	-	118	
122	-	33,7	34,1	31,8	31,9	30,6	30,8	-	34,4	34,6	34,0	34,1	32,5	32,6	26,4	26,5	-	-	122	
126	-	30,7	31,1	28,8	28,9	27,6	27,8	-	31,9	32,1	31,4	31,6	29,5	29,6	24,0	24,1	-	-	126	
130	-	27,6	28,1	25,8	25,9	24,6	24,7	-	28,6	28,6	28,0	28,2	26,3	26,5	22,0	22,2	-	-	130	
134	-	24,6	25,1	22,9	23,0	21,7	21,8	-	25,3	24,8	24,8	24,7	23,2	23,5	19,5	19,8	-	-	134	
136	-	23,1	23,7	21,4	21,6	20,8	20,9	-	23,6	22,9	23,2	22,8	21,6	22,0	18,3	18,6	-	-	136	
138	-	22,2	-	20,2	-	19,9	-	-	22,0	-	21,6	-	20,1	-	16,9	-	-	-	138	
141	-	20,0	-	18,9	-	17,9	-	-	19,4	-	19,2	-	17,7	-	15,0	-	-	-	141	

	0t	65t	95t	125t	165t	205t	265t	325t
--	----	-----	-----	------	------	------	------	------

225 t		12 m x 12 m		9.8 m/s		360°		ISO									
150 m																	
LSL+LF_4			LSL+LF_6			LSL+LF_8			LSL+LF_10			LSL+LF_12			LSL+LF_14		
12 m																	
0 t		0 t - 325 t				0 t		0 t - 325 t									
15°		20°		15°		20°		15°		20°		15°		20°			
m	t	t	t	t	t	t	t	t	t	t	t	t	t	t	m		
19	71,5	73,5	-	81,5	-	92,0	94,0	-	99,0	-	107,0	-	121,0	-	19		
20	71,5	73,0	71,0	81,5	80,5	92,0	94,0	92,5	99,0	97,0	107,0	105,0	121,0	119,0	20		
22	71,2	72,5	70,5	81,2	80,0	92,0	93,7	92,0	98,7	97,0	106,5	105,0	121,0	119,0	22		
24	71,0	72,0	70,5	81,0	80,0	92,0	93,5	92,0	98,5	96,5	106,0	105,0	121,0	119,0	24		
26	70,7	71,7	70,0	80,7	79,5	88,0	93,2	92,0	98,2	96,0	106,0	105,0	121,0	116,5	26		
28	70,5	71,5	69,5	80,5	79,5	86,5	93,0	91,5	98,0	95,5	106,0	104,0	121,0	114,0	28		
30	69,2	70,7	69,0	80,0	79,0	78,7	92,7	91,5	97,2	95,0	105,5	104,0	120,5	111,0	30		
34	64,0	69,5	68,0	79,2	78,3	63,5	92,0	90,5	95,7	94,0	104,5	102,6	120,0	105,5	34		
38	55,3	68,5	67,0	78,5	77,6	50,3	91,0	89,5	94,3	92,6	103,3	101,3	119,0	101,0	38		
42	45,1	67,5	66,0	77,5	77,0	39,1	90,0	88,5	93,0	91,0	102,0	100,0	117,3	97,0	42		
46	36,7	66,1	64,6	76,5	76,0	30,6	88,3	86,8	90,6	88,6	99,6	96,0	116,0	93,0	46		
50	29,2	64,6	63,3	75,5	75,0	23,2	86,5	85,1	88,1	86,3	96,8	92,3	112,0	89,3	50		
54	22,8	63,0	62,0	74,5	74,0	16,8	84,5	83,5	85,5	84,0	93,5	89,0	108,0	86,0	54		
58	17,6	61,6	60,6	73,1	72,6	11,6	82,8	81,8	82,1	80,3	90,8	86,0	104,0	83,0	58		
62	13,0	60,3	59,3	71,8	71,3	6,9	81,2	80,0	79,5	76,1	87,9	83,0	97,3	80,3	62		
65	9,9	59,3	58,3	70,8	70,3	3,8	80,0	78,7	77,2	74,1	85,1	81,1	92,5	78,4	65		
66	8,9	59,0	58,0	70,5	70,0	-	79,5	78,5	76,5	73,5	84,5	80,5	91,0	77,8	66		
70	5,5	57,5	56,5	69,1	68,0	-	77,8	75,8	73,3	69,3	81,5	77,0	85,0	75,5	70		
72	3,8	56,5	56,0	68,5	67,0	-	77,0	75,0	72,0	68,0	80,0	75,5	82,0	74,3	72		
74	-	55,3	54,3	67,5	66,0	-	75,3	73,5	69,5	66,5	77,8	73,8	79,0	73,1	74		
78	-	54,0	53,0	65,5	64,0	-	72,0	70,5	66,5	63,5	74,5	70,5	73,0	71,0	78		
82	-	52,1	51,1	62,6	62,0	-	68,6	67,8	63,8	62,1	70,1	67,5	67,0	67,0	82		
86	-	50,5	49,9	60,3	60,0	-	65,3	65,1	61,3	60,6	65,3	64,5	61,3	61,6	86		
90	-	49,3	48,8	58,0	58,0	-	62,0	62,5	59,0	59,0	60,5	60,5	56,1	56,6	90		
94	-	48,1	47,2	54,0	54,5	-	57,6	57,9	56,3	56,6	55,8	56,1	51,5	52,0	94		
98	-	46,6	45,8	50,1	50,6	-	53,5	53,6	53,0	53,3	51,5	51,5	47,5	47,9	98		
102	-	45,5	44,8	46,5	46,8	-	49,6	49,8	49,1	49,4	47,6	47,9	43,7	44,0	102		
106	-	43,9	43,7	43,0	43,3	-	46,0	46,2	45,5	45,8	44,0	44,3	40,1	40,4	106		
110	-	41,7	42,0	39,6	39,9	-	42,6	42,9	42,2	42,4	40,7	40,9	36,8	37,1	110		
114	-	38,8	39,0	36,3	36,5	-	39,5	39,7	39,1	39,3	37,6	37,8	33,7	34,0	114		
118	-	36,2	36,3	33,1	33,3	-	36,6	36,8	36,2	36,4	34,7	34,9	30,9	31,1	118		
122	-	33,3	33,5	30,0	30,3	-	33,9	34,1	33,5	33,7	32,0	32,2	28,3	28,4	122		
126	-	30,4	30,6	27,1	27,3	-	31,4	31,6	31,0	31,1	29,2	29,3	25,8	25,9	126		
130	-	27,5	27,7	24,2	24,4	-	28,5	28,6	28,0	28,3	26,0	26,1	23,5	23,6	130		
134	-	24,7	24,9	21,4	21,6	-	25,3	25,0	24,8	24,9	23,0	23,1	21,7	21,8	134		
138	-	22,0	22,1	19,2	19,3	-	22,2	21,4	21,8	21,4	20,0	20,2	19,7	19,9	138		
142	-	19,7	-	16,9	-	-	18,8	-	18,6	-	16,8	-	17,5	-	142		
143	-	19,3	-	16,4	-	-	18,0	-	17,9	-	16,1	-	16,9	-	143		

0 t
65 t
95 t
125 t
165 t
205 t
265 t
325 t

225 t		12 m x 12 m						9.8 m/s		360°		ISO			
		153 m													
		LSL+LF_4		LSL+LF_6		LSL+LF_8		LSL+LF_10		LSL+LF_12		LSL+LF_14			
		12 m													
		0 t		0 t-325 t				0 t		0 t-325 t					
		15°		20°		15°		20°		15°		20°			
m	t	t	t	t	t	t	t	t	t	t	t	t	t	m	
19	68,5	70,5	-	77,5	-	87,5	89,5	-	94,0	-	101,0	-	116,0	-	19
20	68,5	70,5	68,5	77,5	76,5	87,5	89,5	-	94,0	-	101,0	-	116,0	-	20
21	68,3	70,2	68,2	77,3	76,2	87,5	89,3	88,0	93,8	92,5	101,0	100,0	116,0	114,0	21
22	68,2	70,0	68,0	77,2	76,0	87,5	89,2	88,0	93,7	92,5	101,0	100,0	116,0	114,0	22
24	68,0	69,5	67,5	77,0	76,0	87,5	89,0	87,5	93,5	92,0	101,0	100,0	116,0	113,0	24
26	67,7	69,0	67,5	76,7	75,5	85,2	88,7	87,5	93,2	91,5	101,0	100,0	115,5	113,0	26
28	67,5	68,5	67,0	76,5	75,5	85,0	88,5	87,0	93,0	91,5	101,0	100,0	115,0	113,0	28
30	67,0	68,0	66,5	76,2	75,0	77,5	88,2	87,0	92,5	90,5	100,5	99,5	114,5	111,0	30
34	62,2	67,0	65,5	75,5	74,3	62,5	87,5	86,3	91,5	89,5	100,0	98,8	114,0	106,5	34
38	54,0	66,1	64,6	74,6	73,6	49,3	86,5	85,3	90,1	88,3	99,3	98,0	113,5	101,7	38
42	44,0	65,5	64,0	74,0	73,0	37,9	85,5	84,0	88,5	87,0	98,0	97,0	112,0	97,5	42
46	35,6	64,1	62,6	73,0	72,3	29,5	84,1	82,6	86,8	85,0	96,0	95,0	110,0	93,5	46
50	28,1	63,0	61,5	72,0	71,5	22,0	82,5	81,1	84,5	82,8	93,5	92,3	106,6	90,1	50
54	21,7	62,0	60,5	71,0	70,5	15,6	80,5	79,5	82,5	80,5	90,5	89,5	103,0	86,9	54
58	16,5	60,6	59,5	70,0	69,5	10,4	79,1	77,8	79,8	77,3	88,5	86,5	99,5	83,5	58
62	11,9	59,3	58,3	68,8	68,5	5,7	77,5	76,3	76,9	74,0	86,5	83,8	94,1	80,8	62
64	9,8	58,6	57,6	68,1	68,0	3,6	76,5	75,5	75,7	72,7	85,5	82,4	91,5	79,5	64
66	7,8	58,0	57,0	67,5	67,5	-	75,5	74,5	74,5	71,5	84,5	81,0	88,3	78,3	66
70	4,3	56,5	56,0	66,6	66,4	-	73,8	72,8	71,1	67,8	81,1	78,1	82,0	76,0	70
74	-	55,3	54,3	65,3	64,8	-	71,8	69,6	68,1	65,0	78,6	74,5	76,6	73,6	74
78	-	54,0	53,0	64,0	62,5	-	69,5	67,0	65,5	62,0	76,0	71,0	71,5	71,1	78
82	-	52,5	51,5	61,1	60,3	-	66,0	64,1	62,3	60,3	70,0	67,6	65,5	66,0	82
86	-	50,9	49,9	58,8	58,3	-	63,0	61,8	59,7	58,7	64,3	63,9	60,1	60,6	86
90	-	49,8	48,9	56,5	56,0	-	59,5	59,5	57,5	57,5	59,0	59,5	54,9	55,5	90
94	-	48,3	47,8	52,8	52,8	-	55,8	56,1	54,8	55,1	54,3	54,8	50,5	50,5	94
98	-	47,2	46,4	49,1	49,2	-	52,0	52,5	51,5	52,0	50,1	50,5	46,3	46,5	98
102	-	46,2	45,2	45,4	45,6	-	48,3	48,6	47,9	48,2	46,3	46,6	42,4	42,7	102
106	-	43,7	43,6	41,8	42,0	-	44,7	45,0	44,3	44,6	42,7	43,0	38,8	39,1	106
110	-	40,8	41,0	38,4	38,6	-	41,4	41,6	40,9	41,1	39,4	39,6	35,5	35,8	110
114	-	37,8	38,0	35,1	35,3	-	38,2	38,5	37,8	38,0	36,2	36,5	32,4	32,6	114
118	-	35,0	35,2	32,0	32,2	-	35,4	35,6	35,0	35,1	33,4	33,6	29,6	29,8	118
122	-	32,3	32,5	29,0	29,2	-	32,7	32,9	32,1	32,2	30,6	30,9	27,0	27,2	122
126	-	29,5	29,7	26,1	26,3	-	30,1	30,3	29,1	29,1	28,0	28,2	24,5	24,7	126
130	-	26,7	26,9	23,3	23,5	-	27,3	27,3	25,5	25,2	24,8	25,0	22,5	22,6	130
134	-	24,0	24,1	20,5	20,7	-	24,4	24,1	21,9	21,3	21,8	21,9	19,9	20,2	134
138	-	21,3	21,4	17,9	18,1	-	21,4	20,7	18,3	17,4	18,9	19,1	17,3	17,6	138
141	-	19,3	19,4	16,4	16,6	-	18,9	18,1	15,5	14,5	16,8	17,1	15,3	15,6	141
142	-	18,8	-	15,9	-	-	18,1	-	14,6	-	16,1	-	14,7	-	142
146	-	17,2	-	13,7	-	-	14,9	-	11,0	-	13,3	-	12,4	-	146



225 t		12 m x 12 m						9.8 m/s		360°		ISO			
156 m															
LSL+LF_4		LSL+LF_6		LSL+LF_8		LSL+LF_10		LSL+LF_12		LSL+LF_14					
12 m															
0 t		0 t - 325 t				0 t		0 t - 325 t							
15°		20°		15°		20°		15°		20°		15°		20°	
m	t	t	t	t	t	t	t	t	t	t	t	t	t	t	m
20	65,0	67,0	-	71,5	-	82,5	84,5	-	89,0	-	96,5	-	110,0	-	20
21	65,0	66,8	65,5	71,5	71,5	82,5	84,3	83,0	88,8	87,5	96,3	95,0	110,0	108,0	21
22	65,0	66,7	65,0	71,5	71,5	82,5	84,2	83,0	88,7	87,5	96,2	95,0	110,0	108,0	22
24	65,0	66,5	65,0	71,5	71,5	82,5	84,0	83,0	88,5	87,0	96,0	95,0	110,0	108,0	24
26	64,7	66,0	64,5	71,5	71,5	81,5	83,7	82,5	88,2	87,0	96,0	95,0	110,0	108,0	26
28	64,5	65,5	64,0	71,5	71,5	81,5	83,5	82,5	88,0	87,0	96,0	95,0	110,0	108,0	28
30	64,2	65,2	64,0	71,5	71,0	75,0	83,2	82,5	87,7	86,5	95,5	94,5	109,5	107,5	30
34	60,0	64,5	63,0	71,2	70,3	61,5	82,7	81,8	87,0	85,5	95,0	93,8	108,5	105,5	34
38	52,7	63,5	62,1	70,5	69,6	48,3	82,0	81,0	85,8	84,3	94,0	92,8	107,5	102,0	38
42	43,1	62,5	61,5	69,5	69,0	37,0	81,0	80,0	84,5	83,0	93,0	92,0	106,3	98,0	42
46	34,7	61,5	60,5	68,8	68,3	28,5	79,6	78,6	83,1	81,3	91,6	90,3	105,0	94,0	46
50	27,2	60,5	59,5	68,0	67,5	21,0	78,3	77,3	81,3	79,6	89,5	88,0	101,6	90,6	50
54	20,7	59,5	58,5	67,0	66,5	14,6	77,0	76,0	79,5	78,0	86,5	85,5	98,3	87,2	54
58	15,5	58,5	57,1	66,0	65,5	9,4	75,3	74,1	77,3	75,6	84,5	83,1	95,0	84,0	58
62	10,9	57,3	56,0	64,9	64,6	4,7	73,6	72,5	75,5	73,5	82,5	80,5	91,0	81,3	62
63	9,9	57,0	55,7	64,6	64,4	3,7	73,2	72,1	75,0	73,0	82,0	80,0	90,0	80,6	63
66	6,8	56,0	55,0	64,0	64,0	-	72,0	71,0	73,5	71,5	80,5	78,5	86,0	78,8	66
69	4,1	55,2	54,4	63,2	63,2	-	71,0	70,0	72,2	69,0	79,0	75,7	81,5	77,0	69
70	-	55,0	54,1	63,0	63,0	-	70,6	69,6	71,8	68,5	78,5	75,1	80,0	76,5	70
74	-	53,3	52,5	61,8	61,6	-	69,1	67,3	69,5	66,1	76,0	72,3	74,6	73,5	74
78	-	52,0	51,5	60,5	60,0	-	67,5	65,0	67,5	63,5	74,0	69,0	69,4	69,5	78
82	-	50,6	50,1	58,5	57,8	-	63,9	62,1	63,5	60,6	68,8	65,6	65,0	65,0	82
86	-	49,5	49,1	56,3	56,0	-	60,5	59,6	60,8	58,5	63,3	62,1	59,3	59,6	86
90	-	48,5	47,7	54,0	53,5	-	57,5	57,5	58,0	56,5	58,0	58,5	54,2	54,8	90
94	-	47,1	46,6	51,2	51,1	-	54,5	54,8	54,6	54,1	53,6	54,1	49,8	50,0	94
98	-	46,0	45,2	47,9	48,1	-	51,0	51,5	51,0	51,0	49,5	49,6	45,5	45,8	98
102	-	45,0	44,3	44,2	44,4	-	47,5	47,8	47,1	47,3	45,5	45,8	41,6	42,0	102
106	-	42,9	42,5	40,6	40,8	-	43,9	44,2	43,5	43,7	41,9	42,2	38,0	38,3	106
110	-	39,8	40,0	37,2	37,4	-	40,5	40,8	40,1	40,3	38,6	38,9	34,7	35,0	110
114	-	36,8	37,0	34,0	34,2	-	37,4	37,6	37,0	37,2	35,5	35,7	31,7	31,9	114
118	-	34,1	34,3	31,0	31,2	-	34,5	34,7	34,1	34,3	32,6	32,8	28,8	29,0	118
122	-	31,4	31,6	28,0	28,2	-	31,7	31,9	31,3	31,5	29,9	30,1	26,2	26,4	122
126	-	28,6	28,8	25,2	25,4	-	28,7	28,8	28,5	28,5	27,3	27,5	23,4	23,2	126
130	-	25,8	26,0	22,4	22,6	-	25,2	25,2	24,9	24,7	24,1	24,3	20,0	19,7	130
134	-	23,2	23,4	19,8	20,0	-	21,8	21,6	21,3	21,0	21,1	21,3	16,8	16,5	134
138	-	20,6	20,8	17,2	17,4	-	18,4	18,0	17,8	17,2	18,3	18,5	13,8	13,7	138
142	-	17,1	18,2	14,9	15,0	-	14,9	14,5	14,2	13,5	15,5	15,7	11,1	11,2	142
143	-	16,2	17,8	14,4	14,5	-	14,1	13,7	13,3	12,6	14,8	15,1	10,5	10,6	143
146	-	13,7	-	12,9	-	-	11,5	-	10,7	-	12,9	-	8,8	-	146
148	-	12,1	-	11,9	-	-	9,8	-	9,0	-	11,6	-	7,8	-	148

	0t	65t	95t	125t	165t	205t	265t	325t
--	----	-----	-----	------	------	------	------	------

225 t		12 m x 12 m						9.8 m/s		360°		ISO			
159 m															
LSL+LF_4		LSL+LF_6		LSL+LF_8		LSL+LF_10		LSL+LF_12		LSL+LF_14					
12 m															
0 t		0 t - 325 t				0 t		0 t - 325 t							
15°		20°		15°		20°		15°		20°		15°		20°	
m	t	t	t	t	t	t	t	t	t	t	t	t	t	t	m
20	62,5	64,5	-	69,5	-	79,0	80,5	-	84,5	-	91,5	-	104,0	-	20
21	62,3	64,2	63,0	69,3	68,5	79,0	80,3	79,5	84,3	83,5	91,5	90,5	104,0	103,0	21
22	62,2	64,0	63,0	69,2	68,5	79,0	80,2	79,5	84,2	83,0	91,5	90,5	104,0	103,0	22
24	62,0	63,5	62,5	69,0	68,5	79,0	80,0	79,0	84,0	83,0	91,5	90,0	104,0	102,0	24
26	62,0	63,2	62,0	68,7	68,0	78,5	79,7	79,0	83,7	82,5	91,2	90,0	104,0	102,0	26
28	62,0	63,0	62,0	68,5	68,0	78,0	79,5	78,5	83,5	82,5	91,0	90,0	104,0	102,0	28
30	61,7	62,5	61,5	68,2	67,5	72,0	79,5	78,5	83,2	82,5	90,7	89,5	103,0	101,5	30
34	58,5	61,7	60,8	67,5	66,8	60,0	79,0	77,5	82,5	81,1	90,2	88,8	102,0	101,0	34
38	51,6	61,1	60,0	66,6	66,1	47,2	78,0	76,5	81,3	79,8	89,3	88,0	101,5	100,2	38
42	42,0	60,5	59,0	66,0	65,5	35,8	77,0	75,5	80,0	78,5	88,0	87,0	100,5	97,8	42
46	33,6	59,5	58,3	65,3	64,8	27,4	75,6	74,1	79,0	77,1	87,0	85,6	99,5	94,5	46
50	26,1	58,5	57,5	64,5	64,0	19,9	74,2	72,6	77,3	75,5	84,7	83,6	96,8	91,1	50
54	19,7	57,5	56,5	63,5	63,0	13,4	72,5	71,0	75,0	73,5	82,5	81,0	94,2	88,0	54
58	14,5	56,5	55,8	62,5	62,3	8,2	70,8	69,3	73,3	71,8	80,1	79,0	91,0	85,0	58
62	9,9	55,6	55,0	61,5	61,5	3,5	69,1	67,6	71,5	69,5	78,0	76,5	87,6	82,0	62
66	5,7	54,5	54,0	60,5	60,5	-	67,5	66,0	69,5	67,5	76,0	74,0	83,0	79,3	66
68	3,9	54,0	53,5	60,0	60,1	-	66,6	65,1	68,5	66,5	75,0	72,8	80,0	78,1	68
70	-	53,5	53,0	59,5	59,8	-	65,8	64,3	67,5	65,5	74,0	71,6	77,0	77,0	70
74	-	52,5	51,8	58,6	58,8	-	64,1	61,5	65,0	62,3	71,1	68,1	72,0	72,0	74
78	-	51,5	50,5	58,0	57,5	-	62,5	59,5	63,0	60,0	69,5	65,5	67,1	67,1	78
82	-	49,8	49,5	55,6	55,5	-	59,5	56,5	60,1	57,0	66,0	62,0	62,5	62,5	82
86	-	48,6	48,3	53,5	53,5	-	56,6	54,6	57,1	55,1	62,0	59,1	58,0	58,5	86
90	-	47,4	47,3	51,5	51,5	-	54,0	53,0	54,5	53,5	57,0	56,5	53,1	53,6	90
94	-	46,2	46,1	49,1	49,3	-	51,3	51,0	51,7	51,5	52,3	52,8	48,5	48,9	94
98	-	44,9	45,1	46,3	46,7	-	48,7	49,1	48,9	49,0	48,0	48,5	44,3	44,6	98
102	-	43,7	44,3	42,7	43,0	-	46,2	46,5	45,8	46,1	44,2	44,6	40,4	40,7	102
106	-	41,5	41,9	39,2	39,5	-	42,6	42,9	42,2	42,4	40,6	40,9	36,8	37,1	106
110	-	38,8	39,0	35,9	36,2	-	39,3	39,6	38,9	39,1	37,3	37,6	33,5	33,7	110
114	-	35,8	36,0	32,7	33,0	-	36,1	36,4	35,7	35,9	34,1	34,4	30,2	30,7	114
118	-	33,1	33,3	29,7	30,0	-	32,5	32,2	32,7	32,5	31,0	31,5	27,0	27,8	118
122	-	30,4	30,6	26,9	27,1	-	28,8	28,0	29,3	28,6	27,6	28,6	22,9	23,7	122
126	-	27,6	27,8	24,1	24,3	-	24,9	23,7	25,4	24,5	23,9	25,7	19,2	19,6	126
130	-	24,9	25,1	21,4	21,6	-	20,9	19,4	21,5	20,3	20,5	22,2	15,7	15,9	130
134	-	22,3	22,3	18,8	19,0	-	16,9	15,2	17,6	16,1	17,3	18,8	12,5	12,8	134
138	-	19,8	19,3	16,3	16,5	-	12,9	10,9	13,8	11,9	14,3	15,6	9,8	10,1	138
142	-	15,6	15,8	13,8	13,9	-	8,9	6,6	9,8	7,7	11,6	12,4	7,2	7,5	142
145	-	12,3	13,5	12,0	12,4	-	6,0	3,6	6,9	4,6	9,7	10,0	5,5	5,8	145
146	-	11,2	-	11,3	-	-	5,0	-	5,9	-	9,1	8,7	4,9	-	146
147	-	10,3	-	10,6	-	-	4,0	-	5,0	-	8,5	-	4,3	-	147
148	-	9,3	-	9,8	-	-	-	-	4,0	-	7,9	-	3,8	-	148
150	-	7,7	-	8,4	-	-	-	-	-	-	6,7	-	-	-	150
151	-	6,9	-	7,6	-	-	-	-	-	-	6,2	-	-	-	151

0 t
65 t
95 t
125 t
165 t
205 t
265 t
325 t

225 t		12 m x 12 m						9.8 m/s		360°		ISO			
162 m						165 m									
LSL+LF_10		LSL+LF_12		LSL+LF_14		LSL+LF_10		LSL+LF_12		LSL+LF_14					
12 m															
0 t		0 t - 325 t						0 t		0 t - 325 t					
15°		20°		15°		20°		15°		20°		15°		20°	
m	t	t	t	t	t	t	t	t	t	t	t	t	t	t	m
20	78,0	80,0	-	86,5	-	100,0	-	74,0	76,0	-	82,5	-	94,5	-	20
21	78,0	79,8	79,0	86,3	85,0	99,7	98,5	74,0	75,8	-	82,3	-	94,5	-	21
22	78,0	79,7	79,0	86,2	85,0	99,5	98,5	74,0	75,7	75,0	82,2	81,5	94,5	93,5	22
24	78,0	79,5	78,5	86,0	85,0	99,5	98,5	74,0	75,5	74,5	82,0	81,0	94,5	93,5	24
26	77,5	79,2	78,5	85,7	85,0	99,2	98,0	73,7	75,2	74,5	82,0	81,0	94,0	93,0	26
28	77,5	79,0	78,0	85,5	84,5	99,0	98,0	73,5	75,0	74,0	82,0	80,5	94,0	93,0	28
30	71,0	78,7	78,0	85,2	84,5	98,5	97,7	68,0	74,7	74,0	81,5	80,0	93,5	92,7	30
34	59,0	78,2	77,0	84,7	83,5	97,7	97,0	57,2	74,2	73,3	80,2	78,6	92,7	92,0	34
38	46,3	77,3	76,0	83,8	82,5	97,2	96,0	44,9	73,5	72,5	78,8	77,3	92,2	91,2	38
42	34,9	76,0	75,0	82,5	81,5	96,3	94,6	33,7	72,5	71,5	77,5	76,0	91,3	90,3	42
46	26,4	75,0	73,6	81,5	79,8	95,0	93,0	25,2	71,5	70,1	75,8	74,3	90,0	89,0	46
50	18,8	73,5	72,2	79,8	78,1	92,6	90,3	17,7	70,1	68,9	74,0	72,5	88,3	86,6	50
53	13,9	72,0	71,0	78,0	76,5	91,0	88,5	12,8	68,9	68,0	72,5	71,0	86,5	85,0	53
54	-	72,0	70,5	77,0	76,0	90,3	87,7	11,2	68,5	67,5	72,0	70,5	85,9	84,3	54
58	-	70,0	68,8	75,0	73,6	87,5	84,5	-	67,1	66,1	69,6	68,1	83,5	81,5	58
62	-	68,3	67,1	73,1	71,5	84,8	81,8	-	65,6	64,6	67,0	65,3	81,1	78,8	62
66	-	67,0	65,5	71,5	69,5	80,6	78,6	-	64,0	63,0	64,0	63,0	77,5	75,8	66
70	-	65,3	64,1	69,5	66,5	75,0	75,0	-	62,3	61,3	61,6	60,1	72,5	72,5	70
74	-	63,5	61,6	66,5	64,3	69,8	70,0	-	60,8	59,9	58,5	57,4	67,5	67,5	74
78	-	61,5	60,0	64,5	61,5	65,1	65,3	-	59,5	58,5	56,0	54,5	62,6	62,8	78
82	-	59,5	56,3	62,0	58,5	60,5	61,0	-	57,5	55,2	53,2	51,8	58,0	58,5	82
86	-	56,5	54,0	58,5	55,8	56,5	56,6	-	55,0	52,8	49,0	49,0	54,1	54,5	86
90	-	53,5	52,0	55,5	53,5	52,2	52,7	-	52,0	50,5	45,7	47,0	50,5	50,6	90
94	-	51,0	50,1	52,1	51,0	47,8	48,2	-	49,3	48,5	42,2	44,7	46,5	46,9	94
98	-	48,1	48,0	48,4	48,2	43,5	43,9	-	46,5	46,3	38,7	42,1	42,3	42,7	98
102	-	45,3	45,6	44,4	44,7	39,6	40,0	-	43,7	44,1	35,4	40,0	38,4	38,8	102
106	-	41,7	42,0	40,8	41,1	36,0	36,4	-	40,4	40,7	32,1	37,9	34,8	35,1	106
110	-	38,4	38,7	37,5	37,8	32,8	33,0	-	37,1	37,3	28,7	34,5	29,8	31,6	110
114	-	35,2	35,5	34,3	34,6	29,0	29,7	-	34,0	34,2	25,2	28,6	25,2	27,3	114
118	-	32,4	32,5	30,5	31,1	24,7	26,3	-	31,0	30,8	20,4	22,8	21,4	22,5	118
122	-	29,2	29,1	26,5	26,9	20,6	21,7	-	27,7	27,2	16,0	17,4	17,6	18,4	122
126	-	25,7	25,3	22,3	22,9	17,2	17,7	-	24,0	23,2	11,8	12,5	13,9	14,6	126
130	-	22,1	21,4	18,4	19,2	13,8	14,0	-	20,2	19,2	8,1	8,3	10,5	10,8	130
134	-	18,5	17,5	14,9	15,7	10,6	10,8	-	16,5	15,2	4,7	4,5	7,4	7,6	134
135	-	17,6	16,5	14,1	14,9	9,9	10,0	-	15,6	14,2	3,9	3,7	6,6	6,8	135
138	-	14,9	13,7	11,7	12,4	7,8	7,9	-	12,8	11,2	-	-	4,5	4,5	138
139	-	13,9	12,7	10,9	11,6	7,1	7,3	-	11,8	10,1	-	-	3,8	3,9	139
142	-	11,2	9,7	8,7	9,4	5,1	5,3	-	9,0	7,1	-	-	-	-	142
144	-	9,4	7,8	7,3	7,9	3,9	4,1	-	7,2	5,1	-	-	-	-	144
145	-	8,5	6,8	6,7	7,2	-	3,6	-	6,2	4,1	-	-	-	-	145
146	-	7,6	5,9	6,1	6,6	-	-	-	5,3	-	-	-	-	-	146
147	-	6,7	4,9	5,5	5,9	-	-	-	4,3	-	-	-	-	-	147
148	-	5,8	4,0	4,9	5,3	-	-	-	-	-	-	-	-	-	148
150	-	4,0	-	3,7	-	-	-	-	-	-	-	-	-	-	150

	0t	65t	95t	125t	165t	205t	265t	325t
--	----	-----	-----	------	------	------	------	------

225 t		12 m x 12 m										9.8 m/s		360°		ISO	
		126 m		129 m		132 m		135 m		138 m		141 m		144 m			
		LSL+LF_14															
		18 m															
		0 t		0t-325t		0 t		0t-325t		0 t		0t-325t		0 t		0t-325t	
		15°		20°		15°		20°		15°		20°		15°		20°	
m	t	t	t	t	t	t	t	t	t	t	t	t	t	t	t	t	t
19	118,0	119,0	-	120,0	-	-	-	-	-	-	-	-	-	-	-	-	-
20	116,0	117,0	-	118,0	-	118,0	118,0	-	119,0	-	115,0	119,0	-	119,0	-	-	-
21	113,5	114,5	82,5	115,5	83,0	115,5	115,5	83,0	116,5	-	114,0	117,0	-	117,0	-	111,0	116,0
22	111,0	112,0	81,0	113,0	81,5	113,0	113,0	82,0	114,0	82,0	113,0	115,0	82,5	115,0	82,5	109,0	116,0
24	107,0	108,0	78,5	108,0	79,0	106,0	109,0	79,5	110,0	79,5	102,0	110,0	80,0	111,0	80,0	98,5	112,0
26	98,2	104,0	76,2	104,5	76,7	96,5	105,0	77,2	106,0	77,2	92,7	106,5	77,7	107,0	78,0	89,2	108,0
28	89,5	100,0	74,0	101,0	74,5	87,0	101,0	75,0	102,0	75,0	83,5	103,0	75,5	103,0	76,0	80,0	104,0
30	79,7	96,5	72,0	97,5	72,5	77,7	97,7	73,0	98,7	73,0	75,0	99,5	73,5	100,0	74,0	72,2	100,7
34	62,7	90,2	68,2	91,0	68,5	61,0	91,7	69,0	92,5	69,2	59,0	93,2	69,7	94,0	70,2	57,1	94,5
38	49,7	84,7	64,7	85,5	65,0	47,7	86,2	65,5	87,0	66,0	45,7	87,7	66,2	88,5	66,7	43,8	89,0
42	39,4	79,8	61,5	80,6	62,0	37,4	81,3	62,5	82,1	63,0	35,3	82,8	63,1	83,6	63,6	33,3	84,1
46	30,4	75,5	58,5	76,0	59,0	28,4	77,0	59,5	77,5	60,0	26,2	78,5	60,5	79,0	61,0	24,3	79,5
50	23,5	71,5	56,1	72,3	56,6	21,5	73,0	57,1	73,8	57,6	19,3	74,5	57,8	75,0	58,3	17,3	75,8
54	17,4	67,8	53,8	68,8	54,3	15,4	69,3	54,8	70,3	55,3	13,2	70,8	55,5	71,3	56,0	11,2	72,3
58	12,1	64,5	51,5	65,5	52,0	10,1	66,0	52,5	67,0	53,0	7,8	67,5	53,5	68,0	54,0	5,8	69,0
59	11,0	63,8	51,1	64,7	51,5	9,0	65,3	52,0	66,2	52,5	6,6	66,8	53,0	67,2	53,5	4,6	68,0
61	8,8	62,5	50,3	63,2	50,7	6,8	64,0	51,2	64,7	51,5	4,3	65,5	52,0	65,8	52,5	-	66,6
62	7,7	61,8	49,9	62,5	50,3	5,7	63,3	50,8	64,0	51,0	-	64,6	51,5	65,2	52,0	-	65,9
64	5,6	60,5	49,1	61,0	49,5	3,5	62,0	50,0	62,5	50,0	-	63,0	50,5	64,0	51,0	-	64,5
66	3,7	59,0	48,2	59,8	48,6	-	60,6	49,0	61,3	49,2	-	61,8	49,7	62,6	50,2	-	63,1
70	-	57,0	46,6	57,5	47,0	-	58,0	47,4	59,0	47,8	-	59,5	48,2	60,0	48,6	-	60,5
74	-	54,6	45,1	55,1	45,5	-	56,0	45,9	56,6	46,3	-	57,1	46,7	57,6	47,1	-	58,5
78	-	52,5	43,7	53,1	44,1	-	54,0	44,5	54,5	44,9	-	55,0	45,3	55,7	45,7	-	56,5
82	-	50,5	42,4	51,5	42,8	-	52,0	43,2	52,5	43,6	-	53,0	44,0	54,0	44,4	-	54,5
86	-	49,3	41,3	49,9	41,7	-	50,5	42,0	51,0	42,4	-	51,5	42,8	52,0	43,2	-	52,5
90	-	47,7	40,2	48,3	40,6	-	48,9	40,9	49,3	41,3	-	49,8	41,6	50,3	42,0	-	51,0
94	-	46,3	39,2	46,8	39,6	-	47,4	39,9	48,0	40,3	-	48,5	40,6	49,0	41,0	-	49,6
98	-	45,0	38,3	45,5	38,7	-	46,0	39,0	46,6	39,3	-	47,1	39,6	47,6	40,0	-	47,8
102	-	43,8	37,5	44,3	37,8	-	44,8	38,2	45,3	38,5	-	45,4	38,8	45,4	39,1	-	45,1
106	-	42,7	36,8	43,2	37,1	-	43,7	37,4	44,1	37,7	-	43,4	38,0	42,1	38,3	-	41,4
110	-	41,7	36,1	42,0	36,4	-	41,8	36,7	41,0	37,0	-	40,0	37,2	38,8	37,5	-	38,0
114	-	40,6	35,5	39,8	35,7	-	39,2	36,1	37,9	36,1	-	36,9	36,0	35,7	35,8	-	34,9
118	-	38,2	35,1	37,0	35,3	-	36,2	35,5	35,0	35,3	-	34,0	34,3	32,8	33,1	-	32,0
122	-	35,5	34,6	34,3	33,9	-	33,5	33,5	32,3	32,5	-	31,3	31,5	30,1	30,3	-	29,3
124	-	34,2	34,4	33,0	33,2	-	32,2	32,5	31,0	31,2	-	30,0	30,2	28,8	29,0	-	28,0
126	-	33,0	-	31,8	31,9	-	31,0	31,2	29,8	30,0	-	28,8	29,0	27,5	27,8	-	26,8
127	-	32,4	-	31,2	31,3	-	30,4	30,6	29,2	29,4	-	28,2	28,4	26,9	27,2	-	26,2
128	-	31,8	-	30,6	-	-	29,8	30,0	28,6	28,8	-	27,6	27,8	26,3	26,6	-	25,6
129	-	-	-	29,9	-	-	29,2	29,4	28,0	28,2	-	27,0	27,2	25,7	26,0	-	25,0
130	-	-	-	29,3	-	-	28,6	-	27,4	27,6	-	26,4	26,6	25,1	25,4	-	24,4
131	-	-	-	28,5	-	-	27,9	-	26,7	26,9	-	25,8	26,0	24,5	24,8	-	23,8
132	-	-	-	-	-	-	27,2	-	26,0	26,3	-	25,3	25,4	24,0	24,2	-	23,3
133	-	-	-	-	-	-	26,5	-	25,3	-	-	24,7	24,8	23,5	23,6	-	22,8
134	-	-	-	-	-	-	-	-	24,6	-	-	24,2	24,3	23,0	23,1	-	22,4
136	-	-	-	-	-	-	-	-	23,3	-	-	23,1	-	22,0	22,2	-	21,5
137	-	-	-	-	-	-	-	-	-	-	-	22,5	-	21,3	21,7	-	20,8
138	-	-	-	-	-	-	-	-	-	-	-	21,9	-	20,7	-	-	20,1
139	-	-	-	-	-	-	-	-	-	-	-	21,4	-	20,0	-	-	19,4
141	-	-	-	-	-	-	-	-	-	-	-	-	-	18,8	-	-	18,0
142	-	-	-	-	-	-	-	-	-	-	-	-	-	-	-	-	17,4
144	-	-	-	-	-	-	-	-	-	-	-	-	-	-	-	-	16,2

0t
65t
95t
125t
165t
205t
265t
325t

225 t		12 m x 12 m												9.8 m/s		360°		ISO
		147 m		150 m		153 m		156 m		159 m		162 m		165 m				
		LSL+LF_14																
		18 m																
		0t-325t		0t		0t-325t		0t		0t-325t		0t		0t-325t				
		15°		20°		15°		20°		15°		20°		15°		20°		
m	t	t	t	t	t	t	t	t	t	t	t	t	t	t	t	t	m	
21	111,0	-	100,0	105,0	-	101,0	-	-	-	-	-	-	-	-	-	-	21	
22	111,0	-	100,0	105,0	-	101,0	-	93,0	97,0	-	92,5	-	86,0	89,0	-	85,0	22	
23	110,5	82,0	98,7	105,0	82,0	101,0	82,5	93,0	97,0	82,5	92,5	-	86,0	89,0	-	85,0	23	
24	110,0	80,5	97,5	105,0	81,0	101,0	81,0	93,0	97,0	81,5	92,5	81,5	86,0	89,0	82,0	85,0	79,0	24
26	107,5	78,5	88,5	105,0	78,7	101,0	79,0	84,5	96,7	79,2	92,5	79,5	79,5	89,0	79,7	84,5	78,5	26
28	105,0	76,5	79,5	105,0	76,5	101,0	77,0	76,0	96,5	77,0	92,5	77,5	73,0	89,0	77,5	84,5	78,0	28
30	101,5	74,5	72,2	102,0	74,7	100,2	75,0	69,2	96,2	75,2	92,0	75,5	66,2	88,7	75,7	84,2	76,2	30
34	95,2	70,7	57,7	96,0	71,2	96,5	71,2	55,5	95,2	71,7	90,7	72,0	53,1	87,5	72,2	83,5	72,7	34
38	89,7	67,5	44,6	90,5	67,7	91,0	68,0	42,7	91,7	68,5	89,5	68,7	40,8	86,0	69,0	82,5	69,5	38
42	84,8	64,5	34,1	85,6	64,6	86,1	65,1	32,2	86,8	65,5	87,0	65,6	30,3	84,3	66,1	80,8	66,5	42
46	80,5	61,5	25,0	81,0	62,0	81,5	62,5	23,1	82,5	62,5	83,0	63,0	21,2	82,0	63,5	78,5	63,5	46
50	76,5	59,1	18,1	77,0	59,6	77,8	59,8	16,1	78,5	60,1	79,0	60,6	14,2	79,0	60,8	76,1	61,1	50
54	72,8	56,8	11,9	73,3	57,3	74,3	57,5	9,8	74,8	58,0	75,2	58,1	7,9	75,9	58,5	73,7	59,0	54
55	72,0	56,2	10,6	72,5	56,7	73,5	57,0	8,4	74,0	57,5	74,3	57,5	6,5	75,1	58,0	73,1	58,5	55
57	70,3	55,0	7,8	70,8	55,5	71,8	56,0	-	72,3	56,5	72,7	56,5	3,8	73,5	57,0	71,7	57,5	57
58	69,5	54,5	6,5	70,0	55,0	71,0	55,5	-	71,5	56,0	72,0	56,0	-	72,5	56,5	71,0	57,0	58
60	68,0	53,5	4,2	68,5	54,0	69,3	54,5	-	70,0	55,0	70,5	55,0	-	71,0	55,5	69,8	56,0	60
62	66,5	52,7	-	67,2	53,0	67,9	53,5	-	68,5	54,0	69,0	54,0	-	69,5	54,5	68,6	55,0	62
66	63,8	51,1	-	64,6	51,2	65,1	51,6	-	65,6	52,1	66,1	52,1	-	66,8	52,6	66,1	53,1	66
70	61,5	49,4	-	62,0	49,8	62,5	50,0	-	63,0	50,5	63,5	50,5	-	64,5	51,0	63,5	51,5	70
74	59,1	47,9	-	59,6	48,2	60,1	48,6	-	60,6	49,0	61,5	49,3	-	62,1	49,6	61,1	50,0	74
78	57,0	46,4	-	57,5	46,8	58,0	47,2	-	58,5	47,5	59,1	47,9	-	59,8	48,2	58,6	48,5	78
82	55,0	45,1	-	55,5	45,5	56,0	45,8	-	56,5	46,2	57,0	46,5	-	57,5	46,8	56,0	47,2	82
86	53,3	43,9	-	53,8	44,2	54,3	44,6	-	54,8	44,9	55,3	45,2	-	54,6	45,6	53,0	45,9	86
90	51,5	42,7	-	52,1	43,0	52,5	43,4	-	53,0	43,7	53,3	44,0	-	51,8	44,4	50,0	44,7	90
94	50,0	41,7	-	50,5	42,0	51,0	42,3	-	51,5	42,6	50,5	42,9	-	49,4	43,3	47,1	43,6	94
98	47,1	40,7	-	48,5	41,0	47,8	41,3	-	47,5	41,6	46,4	41,9	-	45,6	42,2	44,0	42,5	98
102	43,8	39,7	-	45,6	40,1	44,4	40,3	-	43,6	40,6	42,5	40,8	-	41,8	40,6	40,5	40,4	102
106	40,2	38,9	-	42,0	39,2	40,8	39,5	-	40,0	39,8	38,8	39,3	-	38,1	38,6	36,9	37,4	106
110	36,8	36,7	-	38,6	38,0	37,4	37,3	-	36,6	36,8	35,4	35,9	-	34,7	35,2	33,5	34,0	110
114	33,7	34,0	-	35,5	35,9	34,3	34,6	-	33,5	33,9	32,2	32,7	-	31,6	32,0	30,4	30,9	114
118	30,8	31,1	-	32,6	32,9	31,4	31,7	-	30,6	31,0	29,4	29,8	-	28,7	29,1	27,4	27,9	118
122	28,1	28,4	-	29,9	30,2	28,7	29,0	-	27,9	28,2	26,7	27,0	-	26,0	26,3	23,4	24,7	122
126	25,6	25,9	-	27,4	27,6	26,1	26,4	-	25,4	25,7	24,2	24,1	-	23,1	22,9	19,1	20,7	126
130	23,3	23,5	-	25,0	25,2	23,7	24,0	-	23,1	23,4	20,2	20,5	-	18,8	18,7	15,3	16,0	130
134	21,3	21,6	-	22,8	23,0	21,8	22,0	-	20,0	20,8	16,5	16,9	-	14,9	14,9	11,5	11,8	134
138	18,9	19,3	-	21,0	21,2	19,8	20,1	-	17,0	18,0	13,1	13,5	-	11,3	11,4	8,0	8,1	138
142	16,2	16,6	-	19,2	19,4	17,5	18,1	-	14,1	15,0	10,1	10,8	-	8,0	8,5	4,8	4,9	142
143	15,5	-	-	18,5	18,8	16,8	17,4	-	13,4	14,2	9,4	10,1	-	7,3	7,8	4,0	4,2	143
144	14,9	-	-	17,9	18,3	16,2	16,7	-	12,8	13,5	8,8	9,4	-	6,6	7,1	-	3,5	144
146	13,7	-	-	16,7	-	15,0	15,3	-	11,5	12,1	7,5	8,1	-	5,3	5,8	-	-	146
147	-	-	-	16,1	-	14,4	14,6	-	10,8	11,4	6,9	7,4	-	4,6	5,1	-	-	147
148	-	-	-	15,5	-	13,8	-	-	10,2	10,7	6,3	6,8	-	4,0	4,5	-	-	148
149	-	-	-	15,0	-	13,2	-	-	9,6	10,0	5,7	6,1	-	-	3,9	-	-	149
150	-	-	-	-	-	12,6	-	-	9,0	-	5,1	5,5	-	-	-	-	-	150
151	-	-	-	-	-	12,0	-	-	8,4	-	4,5	4,9	-	-	-	-	-	151
152	-	-	-	-	-	11,5	-	-	7,9	-	3,9	-	-	-	-	-	-	152
154	-	-	-	-	-	-	-	-	6,8	-	-	-	-	-	-	-	-	154

0t
65t
95t
125t
165t
205t
265t
325t

225 t		12 m x 12 m												9.8 m/s			360°			ISO									
		72 m				78 m				84 m				90 m			96 m												
		LSL+LF_2																											
		24 m																											
		0 t			0t-325t			0 t			0t-325t			0 t			0t-325t			0 t			0t-325t						
		15°			20°			30°			15°			20°			30°			15°			20°			30°			
m	t	t	t	t	t	t	t	t	t	t	t	t	t	t	t	t	t	t	t	t	t	t	t	t	t	t	m		
16	86,5	86,5	-	-	-	-	-	-	-	-	-	-	-	-	-	-	-	-	-	-	-	-	-	-	-	-	16		
17	84,0	84,0	-	-	85,5	85,5	-	-	86,5	86,5	-	-	84,0	84,0	-	-	-	-	-	-	-	-	-	-	-	-	-	17	
18	81,5	81,5	63,5	-	83,0	83,0	-	-	84,0	84,0	-	-	85,5	85,5	-	-	86,0	86,5	-	-	-	-	-	-	-	-	-	18	
19	79,2	79,2	62,0	-	80,7	80,7	62,5	-	81,7	81,7	63,0	-	83,2	83,2	-	-	84,0	84,2	-	-	-	-	-	-	-	-	-	19	
20	77,0	77,0	60,5	-	78,5	78,5	61,0	-	79,5	79,5	62,0	-	81,0	81,0	62,5	-	82,0	82,0	63,0	-	-	-	-	-	-	-	-	20	
22	72,5	72,5	57,5	38,2	74,5	74,5	58,5	38,4	75,5	75,5	59,0	-	77,0	77,0	60,0	-	78,5	78,5	60,5	-	-	-	-	-	-	-	-	22	
23	70,7	70,7	56,2	37,5	72,5	72,5	57,2	37,8	73,7	73,7	57,7	38,0	75,2	75,2	58,7	38,2	76,7	76,7	59,2	-	-	-	-	-	-	-	-	23	
24	69,0	69,0	55,0	36,9	70,5	70,5	56,0	37,2	72,0	72,0	56,5	37,4	73,5	73,5	57,5	37,6	75,0	75,0	58,0	37,8	-	-	-	-	-	-	-	24	
26	65,5	65,5	52,5	35,7	67,0	67,0	53,5	36,0	69,0	69,0	54,5	36,3	70,0	70,0	55,5	36,5	71,5	71,5	56,0	36,8	-	-	-	-	-	-	-	26	
28	62,5	62,5	50,5	34,5	64,0	64,0	51,5	34,9	66,0	66,0	52,5	35,2	67,5	67,5	53,5	35,5	68,5	68,5	54,0	35,8	-	-	-	-	-	-	-	28	
30	59,5	59,5	48,8	33,5	61,5	61,5	49,8	33,9	63,0	63,0	50,5	34,2	64,5	64,5	51,5	34,5	66,0	66,0	52,5	34,8	-	-	-	-	-	-	-	30	
34	54,8	54,8	45,4	31,6	56,8	56,8	46,4	32,1	58,3	58,3	47,3	32,4	59,8	59,8	48,3	32,8	61,3	61,3	49,3	33,1	-	-	-	-	-	-	-	34	
38	50,7	50,7	42,3	29,9	52,6	52,6	43,4	30,4	54,1	54,1	44,4	30,8	55,6	55,6	45,4	31,2	57,0	57,0	46,3	31,6	-	-	-	-	-	-	-	38	
42	47,3	47,3	39,6	28,4	48,9	48,9	40,8	28,9	50,5	50,5	41,8	29,4	52,0	52,0	42,7	29,8	53,0	53,0	43,7	30,2	-	-	-	-	-	-	-	42	
46	44,3	44,3	37,4	27,1	45,9	45,9	38,5	27,6	47,4	47,4	39,5	28,1	48,8	48,8	40,5	28,5	50,1	50,1	41,4	28,9	-	-	-	-	-	-	-	46	
50	41,6	41,6	35,4	25,9	43,1	43,1	36,4	26,4	44,6	44,6	37,4	26,9	45,5	46,0	38,4	27,3	46,1	47,4	39,3	27,7	-	-	-	-	-	-	-	50	
54	39,2	39,2	33,6	24,9	40,6	40,6	34,6	25,4	42,1	42,1	35,6	25,9	42,0	43,4	36,6	26,3	41,1	44,8	37,4	26,7	-	-	-	-	-	-	-	54	
58	37,1	37,1	32,0	24,0	38,5	38,5	33,0	24,5	38,1	39,9	34,0	24,9	36,8	41,2	34,9	25,4	35,9	42,5	35,8	25,8	-	-	-	-	-	-	-	58	
62	35,2	35,2	30,6	23,2	35,6	36,6	31,6	23,7	34,2	38,0	32,5	24,1	32,4	39,2	33,4	24,6	31,2	40,4	34,3	25,0	-	-	-	-	-	-	-	62	
66	33,6	33,6	29,4	22,5	31,8	34,9	30,3	22,9	30,6	36,2	31,2	23,4	28,8	37,4	32,1	23,8	27,1	38,6	32,9	24,2	-	-	-	-	-	-	-	66	
70	30,1	32,2	28,3	21,9	28,2	33,4	29,1	22,3	27,1	34,6	30,0	22,7	25,2	35,8	30,9	23,1	24,1	37,0	31,7	23,5	-	-	-	-	-	-	-	70	
74	26,9	30,9	27,3	21,4	25,0	32,1	28,1	21,7	23,9	33,2	29,0	22,1	22,0	34,4	29,8	22,5	21,1	35,5	30,5	22,9	-	-	-	-	-	-	-	74	
76	25,4	30,3	26,9	21,2	23,5	31,5	27,7	21,5	22,4	32,6	28,5	21,9	20,5	33,7	29,3	22,2	19,6	34,8	30,0	22,6	-	-	-	-	-	-	-	76	
78	24,0	29,8	26,5	-	22,1	30,9	27,3	21,3	20,9	32,0	28,0	21,7	19,1	33,0	28,8	22,0	18,1	34,1	29,5	22,3	-	-	-	-	-	-	-	78	
80	22,7	29,3	26,1	-	20,8	30,3	26,9	21,1	19,6	31,4	27,6	21,5	17,8	32,4	28,3	21,7	16,8	33,5	29,0	22,0	-	-	-	-	-	-	-	80	
82	21,4	28,8	25,8	-	19,6	29,8	26,5	-	18,4	30,8	27,2	21,3	16,5	31,8	27,9	21,5	15,5	32,9	28,6	21,8	-	-	-	-	-	-	-	82	
84	20,2	28,4	25,5	-	18,4	29,3	26,2	-	17,2	30,3	26,8	21,1	15,3	31,3	27,5	21,3	14,3	32,3	28,2	21,6	-	-	-	-	-	-	-	84	
85	19,6	28,2	-	-	17,8	29,1	26,0	-	16,6	30,0	26,6	21,0	14,7	31,0	27,3	21,2	13,7	32,0	28,0	21,5	-	-	-	-	-	-	-	85	
86	19,1	28,0	-	-	17,3	28,9	25,9	-	16,1	29,8	26,5	-	14,2	30,8	27,1	21,1	13,2	31,8	27,8	21,4	-	-	-	-	-	-	-	86	
87	18,6	27,8	-	-	16,7	28,7	25,7	-	15,5	29,6	26,3	-	13,6	30,5	27,0	21,0	12,7	31,5	27,6	21,3	-	-	-	-	-	-	-	87	
89	-	-	-	-	15,6	28,3	25,5	-	14,4	29,2	26,0	-	12,5	30,0	26,6	20,9	11,6	31,0	27,2	21,1	-	-	-	-	-	-	-	89	
90	-	-	-	-	15,1	28,1	-	-	13,9	29,0	25,9	-	12,0	29,8	26,5	-	11,1	30,8	27,1	21,1	-	-	-	-	-	-	-	90	
92	-	-	-	-	14,1	27,8	-	-	12,9	28,6	25,6	-	11,0	29,4	26,2	-	10,1	30,3	26,7	20,9	-	-	-	-	-	-	-	92	
93	-	-	-	-	-	-	-	-	12,5	28,4	25,5	-	10,6	29,2	26,0	-	9,6	30,1	26,6	20,8	-	-	-	-	-	-	-	93	
94	-	-	-	-	-	-	-	-	12,0	28,2	25,4	-	10,1	29,0	25,9	-	9,1	29,8	26,4	-	-	-	-	-	-	-	-	94	
98	-	-	-	-	-	-	-	-	10,2	27,6	-	-	8,3	28,3	25,4	-	7,3	29,0	25,8	-	-	-	-	-	-	-	-	98	
99	-	-	-	-	-	-	-	-	-	-	-	-	7,9	28,1	25,3	-	6,9	28,8	25,7	-	-	-	-	-	-	-	-	99	
102	-	-	-	-	-	-	-	-	-	-	-	-	6,7	27,7	-	-	5,7	28,3	25,4	-	-	-	-	-	-	-	-	102	
103	-	-	-	-	-	-	-	-	-	-	-	-	6,3	27,5	-	-	5,3	28,2	25,3	-	-	-	-	-	-	-	-	103	
104	-	-	-	-	-	-	-	-	-	-	-	-	-	-	-	-	4,9	28,0	25,2	-	-	-	-	-	-	-	-	104	
106	-	-	-	-	-	-	-	-	-	-	-	-	-	-	-	-	4,2	27,7	-	-	-	-	-	-	-	-	-	106	
108	-	-	-	-	-	-	-	-	-	-	-	-	-	-	-	-	3,5	27,5	-	-	-	-	-	-	-	-	-	108	

0t
65t
95t
125t
165t
205t
265t
325t

225 t		12 m x 12 m								9.8 m/s		360°		ISO					
102 m				105 m				108 m				111 m							
LSL+LF_2				LSL+LF_4				LSL+LF_2				LSL+LF_4							
24 m																			
0 t		0t-325t								0 t		0t-325t							
15°		20°		30°		15°		20°		15°		20°		30°		15°		20°	
m	t	t	t	t	t	t	t	t	t	t	t	t	t	t	t	t	t	t	m
19	84,5	85,5	-	-	-	-	-	-	83,5	86,0	-	-	-	-	-	-	-	-	19
20	83,0	83,5	-	-	-	-	-	-	82,5	84,5	-	-	-	-	-	-	-	-	20
21	81,2	81,5	62,5	-	-	57,0	-	57,0	81,5	82,5	63,0	-	-	57,5	-	-	-	-	21
22	79,5	79,5	61,0	-	-	56,0	-	56,0	80,5	80,5	61,5	-	-	56,5	-	56,5	-	56,5	22
24	76,0	76,0	59,0	38,0	-	54,0	-	54,5	77,0	77,0	59,5	-	-	54,5	-	54,5	-	54,5	24
25	74,5	74,5	58,0	37,4	-	53,0	-	53,5	75,5	75,5	58,5	37,6	-	53,5	-	53,7	-	53,7	25
26	73,0	73,0	57,0	36,9	-	52,0	-	52,5	74,0	74,0	57,5	37,1	-	52,5	-	53,0	-	53,0	26
28	70,0	70,0	55,0	36,0	-	50,5	-	51,0	71,0	71,0	55,5	36,2	-	51,0	-	51,5	-	51,5	28
30	67,0	67,0	53,0	35,1	-	49,1	-	49,4	68,5	68,5	53,5	35,3	-	49,7	-	50,0	-	50,0	30
34	62,3	62,3	50,0	33,4	-	46,3	-	46,6	63,8	63,8	50,6	33,7	-	47,0	-	47,3	-	47,3	34
38	58,1	58,1	47,1	31,9	-	43,9	-	44,2	59,6	59,6	47,9	32,2	-	44,6	-	44,9	-	44,9	38
42	54,5	54,5	44,5	30,5	-	41,7	-	42,0	56,0	56,0	45,3	30,8	-	42,4	-	42,8	-	42,8	42
46	50,9	51,5	42,3	29,3	-	39,7	-	40,0	50,0	52,6	43,1	29,6	-	40,4	-	40,8	-	40,8	46
50	45,8	48,6	40,2	28,1	-	37,8	-	38,2	43,8	49,7	41,0	28,5	-	38,6	-	39,0	-	39,0	50
54	39,3	46,0	38,3	27,1	-	36,0	-	36,4	37,2	47,2	39,1	27,5	-	36,8	-	37,3	-	37,3	54
58	34,1	43,8	36,6	26,1	-	34,4	-	34,8	32,0	44,9	37,4	26,5	-	35,2	-	35,7	-	35,7	58
62	29,4	41,7	35,1	25,3	-	33,0	-	33,4	27,3	42,8	35,9	25,7	-	33,8	-	34,2	-	34,2	62
66	25,2	39,8	33,7	24,6	-	31,6	-	32,1	23,1	40,9	34,5	24,9	-	32,5	-	32,9	-	32,9	66
70	22,2	38,1	32,5	23,8	-	30,5	-	30,9	19,5	39,2	33,2	24,2	-	31,3	-	31,7	-	31,7	70
74	19,2	36,5	31,3	23,2	-	29,5	-	29,9	16,5	37,6	32,0	23,6	-	30,2	-	30,6	-	30,6	74
78	16,3	35,1	30,3	22,7	-	28,6	-	29,0	14,1	36,2	31,0	23,0	-	29,3	-	29,6	-	29,6	78
82	13,7	33,9	29,3	22,1	-	27,7	-	28,0	11,5	34,8	30,0	22,4	-	28,4	-	28,8	-	28,8	82
86	11,3	32,7	28,5	21,7	-	26,9	-	27,2	9,2	33,6	29,1	22,0	-	27,6	-	28,0	-	28,0	86
90	9,2	31,7	27,7	21,3	-	26,1	-	26,5	7,0	32,6	28,3	21,6	-	26,8	-	27,2	-	27,2	90
94	7,2	30,7	27,0	20,9	-	25,5	-	25,8	5,0	31,6	27,6	21,2	-	26,1	-	26,4	-	26,4	94
97	5,8	30,1	26,5	20,8	-	25,0	-	25,3	3,7	30,9	27,1	21,0	-	25,6	-	25,9	-	25,9	97
98	5,4	29,9	26,4	20,7	-	24,9	-	25,1	-	30,6	26,9	20,9	-	25,5	-	25,8	-	25,8	98
102	3,8	29,1	25,9	-	-	24,4	-	24,6	-	29,8	26,3	20,6	-	24,9	-	25,2	-	25,2	102
106	-	28,4	25,4	-	-	24,0	-	24,2	-	29,1	25,8	-	-	24,4	-	24,6	-	24,6	106
109	-	27,9	25,1	-	-	23,7	-	23,9	-	28,6	25,5	-	-	24,1	-	24,3	-	24,3	109
110	-	27,8	25,0	-	-	-	-	23,8	-	28,5	25,4	-	-	24,0	-	24,2	-	24,2	110
112	-	27,5	-	-	-	-	-	23,7	-	28,2	25,2	-	-	23,8	-	24,0	-	24,0	112
113	-	27,4	-	-	-	-	-	-	-	28,0	25,1	-	-	23,7	-	23,9	-	23,9	113
114	-	-	-	-	-	-	-	-	-	27,9	25,0	-	-	23,7	-	23,9	-	23,9	114
115	-	-	-	-	-	-	-	-	-	27,7	25,0	-	-	23,6	-	23,8	-	23,8	115
117	-	-	-	-	-	-	-	-	-	27,5	-	-	-	-	-	23,6	-	23,6	117
118	-	-	-	-	-	-	-	-	-	27,4	-	-	-	-	-	-	-	-	118

0t
65t
95t
125t
165t
205t
265t
325t

225 t		12 m x 12 m				9.8 m/s		360°		ISO	
114 m		117 m				120 m		123 m			
LSL+LF_2		LSL+LF_4				LSL+LF_2		LSL+LF_4			
0 t		0 t-325 t				0 t		0 t-325 t			
15°		20°		30°		15°		20°		15°	
m	t	t	t	t	t	t	t	t	t	t	m
20	80,5	83,0	-	-	-	-	-	-	-	-	20
21	80,0	82,0	-	-	-	-	-	-	-	-	21
22	79,5	81,0	62,0	-	-	56,5	-	57,0	74,0	77,0	22
23	78,5	79,5	61,0	-	-	55,7	-	56,0	73,5	76,5	23
24	77,5	78,0	60,0	-	-	55,0	-	55,0	73,5	76,0	24
26	75,0	75,0	58,0	37,3	-	53,0	-	53,5	73,5	75,0	26
28	72,5	72,5	56,0	36,4	-	51,5	-	52,0	72,5	73,5	28
30	69,5	69,5	54,5	35,5	-	50,0	-	50,5	70,5	70,5	30
34	64,8	64,8	51,5	33,9	-	47,5	-	47,9	66,1	66,1	34
38	60,6	60,6	48,7	32,4	-	45,2	-	45,5	61,0	62,0	38
42	57,0	57,0	46,1	31,1	-	43,1	-	43,4	57,0	58,0	42
46	49,2	53,6	43,8	29,9	-	41,1	-	41,5	48,5	55,0	46
50	42,0	50,8	41,7	28,8	-	39,3	-	39,7	41,0	52,1	50
54	35,4	48,4	39,9	27,8	-	37,6	-	38,1	34,4	49,5	54
58	30,2	46,0	38,2	26,8	-	36,0	-	36,5	29,1	47,1	58
62	25,4	43,9	36,6	26,0	-	34,6	-	35,1	24,3	45,0	62
66	21,2	42,0	35,2	25,2	-	33,3	-	33,7	20,1	43,0	66
70	17,6	40,2	33,9	24,5	-	32,1	-	32,5	16,6	41,2	70
74	14,6	38,6	32,7	23,9	-	31,0	-	31,4	13,4	39,6	74
78	12,2	37,1	31,7	23,3	-	30,0	-	30,4	10,4	38,1	78
82	9,6	35,8	30,7	22,7	-	29,1	-	29,5	8,3	36,7	82
86	7,2	34,6	29,7	22,2	-	28,3	-	28,7	6,1	35,5	86
90	5,0	33,4	28,9	21,8	-	27,5	-	27,9	3,9	34,3	90
93	3,6	32,7	28,4	21,5	-	26,9	-	27,3	-	33,5	93
94	-	32,4	28,2	21,4	-	26,7	-	27,1	-	33,2	94
98	-	31,4	27,5	21,0	-	26,1	-	26,4	-	32,2	98
102	-	30,6	26,9	20,8	-	25,5	-	25,8	-	31,4	102
106	-	29,8	26,3	20,5	-	24,9	-	25,2	-	30,6	106
107	-	29,6	26,1	20,5	-	24,8	-	25,0	-	30,4	107
110	-	29,1	25,8	-	-	24,5	-	24,7	-	29,8	110
111	-	28,9	25,7	-	-	24,4	-	24,6	-	29,6	111
114	-	28,5	25,4	-	-	24,1	-	24,3	-	29,1	114
118	-	27,9	25,0	-	-	23,7	-	23,9	-	28,5	118
120	-	27,7	24,9	-	-	23,6	-	23,8	-	28,2	120
122	-	27,4	-	-	-	-	-	23,6	-	27,9	122
124	-	27,2	-	-	-	-	-	-	-	27,7	124
125	-	-	-	-	-	-	-	-	-	27,6	125
126	-	-	-	-	-	-	-	-	-	27,5	126
127	-	-	-	-	-	-	-	-	-	27,4	127
129	-	-	-	-	-	-	-	-	-	27,2	129

0 t
65 t
95 t
125 t
165 t
205 t
265 t
325 t

225 t														12 m x 12 m		9.8 m/s		360°		ISO	
126 m														129 m							
LSL+LF_2				LSL+LF_4				LSL+LF_14				LSL+LF_4		LSL+LF_14							
24 m																					
0 t														0 t - 325 t							
		15°		20°		30°		15°		20°		15°		20°							
m	t	t	t	t	t	t	t	t	t	t	t	t	t	m							
21	67,5	70,5	-	-	-	-	88,0	-	-	-	89,0	-	21								
22	67,5	70,5	-	-	-	-	86,0	-	-	-	87,0	-	22								
23	67,5	70,2	61,0	-	-	62,5	84,5	61,5	-	62,5	85,2	-	23								
24	67,5	70,0	60,0	-	-	61,5	83,0	60,5	-	62,0	83,5	60,5	24								
26	67,5	69,5	59,0	-	-	60,0	80,0	58,5	-	60,5	80,5	58,7	26								
27	67,5	69,5	58,2	37,1	-	59,2	78,5	57,5	-	59,7	79,0	57,8	27								
28	67,5	69,5	57,5	36,6	-	58,5	77,0	56,5	-	59,0	77,5	57,0	28								
30	66,5	68,0	55,5	35,8	-	57,0	74,2	55,0	-	57,5	74,7	55,2	30								
34	64,1	65,3	52,5	34,3	-	54,0	69,2	52,0	-	54,8	69,7	52,2	34								
38	59,5	62,3	49,8	32,9	-	51,4	65,0	49,3	-	52,2	65,5	49,7	38								
42	56,5	59,0	47,4	31,6	-	49,3	61,1	47,0	-	49,7	61,6	47,3	42								
46	47,9	56,0	45,2	30,4	-	47,2	57,5	44,8	-	47,7	58,0	45,1	46								
50	40,2	53,1	43,1	29,4	-	45,3	54,5	42,8	-	45,7	55,0	43,1	50								
54	33,6	50,5	41,3	28,4	-	43,5	51,8	40,9	-	43,9	52,3	41,2	54								
58	28,4	48,2	39,6	27,4	-	41,8	49,4	39,3	-	42,2	50,0	39,6	58								
62	23,6	46,0	38,0	26,6	-	40,2	47,2	37,7	-	40,6	47,7	38,0	62								
66	19,4	44,0	36,6	25,8	-	38,7	45,1	36,3	-	39,2	45,6	36,6	66								
70	15,8	42,2	35,3	25,1	-	37,3	43,2	35,0	-	37,8	43,7	35,4	70								
74	12,6	40,6	34,1	24,5	-	36,1	41,5	33,8	-	36,6	42,0	34,2	74								
78	9,6	39,0	33,0	23,9	-	35,0	39,9	32,7	-	35,4	40,4	33,0	78								
82	7,5	37,6	32,0	23,3	-	34,0	38,5	31,7	-	34,4	38,9	32,0	82								
86	5,3	36,4	31,0	22,7	-	33,1	37,1	30,8	-	33,5	37,6	31,1	86								
89	3,7	35,5	30,3	22,4	-	32,5	36,2	30,2	-	32,8	36,7	30,4	89								
90	-	35,2	30,1	22,3	-	32,3	35,9	30,0	-	32,6	36,4	30,2	90								
94	-	34,1	29,3	21,9	-	31,4	34,8	29,2	-	31,7	35,2	29,4	94								
98	-	33,1	28,5	21,5	-	30,6	33,7	28,4	-	30,9	34,1	28,7	98								
102	-	32,1	27,9	21,2	-	29,9	32,7	27,8	-	30,2	33,2	28,0	102								
106	-	31,3	27,3	20,9	-	29,3	31,9	27,2	-	29,5	32,3	27,4	106								
110	-	30,5	26,7	20,6	-	28,7	31,1	26,6	-	28,9	31,4	26,8	110								
114	-	29,8	26,2	20,4	-	28,1	30,3	26,1	-	28,3	30,6	26,3	114								
116	-	29,4	25,9	20,3	-	27,8	29,9	25,9	-	28,1	30,3	26,1	116								
118	-	29,1	25,7	-	-	27,6	29,6	25,7	-	27,8	30,0	25,9	118								
122	-	28,5	25,3	-	-	27,2	29,0	25,3	-	27,4	29,3	25,5	122								
126	-	28,0	25,0	-	-	26,8	28,5	24,9	-	27,0	28,7	25,1	126								
130	-	27,5	24,7	-	-	26,5	28,0	24,7	-	26,7	28,3	24,8	130								
133	-	27,2	-	-	-	-	27,7	-	-	26,5	27,4	24,7	133								
134	-	27,1	-	-	-	-	27,6	-	-	-	26,9	-	134								
137	-	-	-	-	-	-	-	-	-	-	25,5	-	137								

0 t
65 t
95 t
125 t
165 t
205 t
265 t
325 t

225 t														12 m x 12 m		9.8 m/s		360°		ISO															
132 m														135 m																					
LSL+LF_2				LSL+LF_4				LSL+LF_14				LSL+LF_4				LSL+LF_14																			
24 m																																			
0 t														0 t-325 t																					
15°		20°		30°		15°		20°		15°		20°		15°		20°		15°		20°															
m	t	t	t	t	t	t	t	t	t	t	t	t	t	t	t	t	t	t	t	t	t	m													
22	61,0	63,0	-	-	-	-	-	87,5	-	-	-	88,0	-	-	-	-	-	-	-	-	-	22													
24	61,0	63,0	56,5	-	-	-	62,0	84,0	60,5	-	61,5	84,5	61,0	-	-	-	-	-	-	-	-	24													
26	61,0	62,5	56,0	-	-	-	60,5	81,0	58,7	-	60,5	81,5	59,2	-	-	-	-	-	-	-	-	26													
27	61,0	62,2	56,0	37,2	-	-	59,5	79,5	57,8	-	59,7	80,0	58,3	-	-	-	-	-	-	-	-	27													
28	61,0	62,0	56,0	36,7	-	-	58,5	78,0	57,0	-	59,0	78,5	57,5	-	-	-	-	-	-	-	-	28													
30	61,0	62,0	55,5	35,9	-	-	57,5	75,5	55,5	-	57,5	76,0	55,7	-	-	-	-	-	-	-	-	30													
34	60,0	60,6	52,8	34,5	-	-	54,5	70,5	52,5	-	54,8	71,0	52,7	-	-	-	-	-	-	-	-	34													
38	56,8	59,3	50,3	33,1	-	-	51,9	66,0	49,9	-	52,3	66,5	50,3	-	-	-	-	-	-	-	-	38													
42	54,5	58,0	48,1	31,8	-	-	49,9	62,1	47,6	-	50,0	62,6	47,9	-	-	-	-	-	-	-	-	42													
46	46,0	56,3	45,9	30,6	-	-	47,8	58,5	45,4	-	48,2	59,0	45,7	-	-	-	-	-	-	-	-	46													
50	39,2	54,1	43,8	29,6	-	-	45,9	55,5	43,4	-	46,4	56,0	43,7	-	-	-	-	-	-	-	-	50													
54	32,6	51,5	41,9	28,6	-	-	44,1	52,8	41,6	-	44,6	53,3	41,9	-	-	-	-	-	-	-	-	54													
58	27,3	49,2	40,2	27,7	-	-	42,4	50,5	39,9	-	42,9	51,0	40,2	-	-	-	-	-	-	-	-	58													
62	22,5	47,0	38,6	26,9	-	-	40,8	48,2	38,3	-	41,3	48,8	38,7	-	-	-	-	-	-	-	-	62													
66	18,3	45,0	37,2	26,1	-	-	39,4	46,1	36,9	-	39,8	46,6	37,2	-	-	-	-	-	-	-	-	66													
70	14,7	43,2	35,9	25,4	-	-	38,0	44,2	35,7	-	38,4	44,7	36,0	-	-	-	-	-	-	-	-	70													
74	11,5	41,5	34,7	24,7	-	-	36,8	42,5	34,5	-	37,2	42,9	34,8	-	-	-	-	-	-	-	-	74													
78	8,5	40,0	33,6	24,1	-	-	35,6	40,9	33,3	-	36,0	41,3	33,6	-	-	-	-	-	-	-	-	78													
82	5,9	38,6	32,6	23,5	-	-	34,6	39,4	32,3	-	35,0	39,8	32,6	-	-	-	-	-	-	-	-	82													
86	3,9	37,2	31,6	23,0	-	-	33,7	38,0	31,4	-	34,0	38,5	31,6	-	-	-	-	-	-	-	-	86													
87	3,6	36,9	31,4	22,9	-	-	33,5	37,7	31,2	-	33,8	38,1	31,4	-	-	-	-	-	-	-	-	87													
90	-	36,0	30,7	22,6	-	-	32,9	36,8	30,5	-	33,2	37,2	30,8	-	-	-	-	-	-	-	-	90													
94	-	34,8	29,9	22,1	-	-	32,0	35,6	29,7	-	32,3	36,0	30,0	-	-	-	-	-	-	-	-	94													
98	-	33,8	29,1	21,7	-	-	31,2	34,5	28,9	-	31,5	34,9	29,2	-	-	-	-	-	-	-	-	98													
102	-	32,9	28,4	21,4	-	-	30,5	33,5	28,3	-	30,7	33,9	28,5	-	-	-	-	-	-	-	-	102													
106	-	32,0	27,8	21,0	-	-	29,8	32,6	27,6	-	30,0	33,0	27,9	-	-	-	-	-	-	-	-	106													
110	-	31,2	27,2	20,8	-	-	29,2	31,8	27,1	-	29,4	32,1	27,3	-	-	-	-	-	-	-	-	110													
114	-	30,4	26,6	20,5	-	-	28,6	31,0	26,5	-	28,8	31,3	26,8	-	-	-	-	-	-	-	-	114													
118	-	29,7	26,1	20,3	-	-	28,0	30,3	26,1	-	28,3	30,6	26,3	-	-	-	-	-	-	-	-	118													
120	-	29,4	25,9	20,2	-	-	27,8	29,9	25,9	-	28,0	30,2	26,0	-	-	-	-	-	-	-	-	120													
122	-	29,1	25,7	-	-	-	27,6	29,6	25,7	-	27,8	29,9	25,8	-	-	-	-	-	-	-	-	122													
126	-	28,5	25,3	-	-	-	27,2	28,9	25,3	-	27,4	29,3	25,4	-	-	-	-	-	-	-	-	126													
130	-	28,0	25,0	-	-	-	26,8	28,3	25,0	-	27,0	28,1	25,1	-	-	-	-	-	-	-	-	130													
134	-	27,6	24,6	-	-	-	26,5	26,5	24,7	-	26,6	25,8	24,8	-	-	-	-	-	-	-	-	134													
135	-	27,5	24,6	-	-	-	26,5	26,0	24,7	-	26,5	25,2	24,7	-	-	-	-	-	-	-	-	135													
138	-	27,2	-	-	-	-	-	24,6	-	-	26,4	23,5	24,0	-	-	-	-	-	-	-	-	138													
139	-	27,1	-	-	-	-	-	24,2	-	-	-	22,9	-	-	-	-	-	-	-	-	-	139													
142	-	-	-	-	-	-	-	-	-	-	-	21,1	-	-	-	-	-	-	-	-	-	142													

0 t
65 t
95 t
125 t
165 t
205 t
265 t
325 t

225 t														12 m x 12 m		9.8 m/s		360°		ISO	
138 m														141 m							
LSL+LF_2				LSL+LF_4				LSL+LF_14				LSL+LF_4		LSL+LF_14							
24 m																					
0 t														0 t-325 t							
		15°		20°		30°		15°		20°		15°		20°		15°		20°			
m	t	t	t	t	t	t	t	t	t	t	t	t	t	t	t	t	t	m			
22	53,5	55,5	-	-	-	-	-	87,5	-	-	-	89,0	-	-	-	-	-	22			
24	53,5	55,0	50,5	-	-	-	61,0	85,0	61,0	-	59,5	85,5	-	-	-	-	-	24			
25	53,2	54,7	50,2	-	-	-	60,5	83,5	60,1	-	59,2	84,0	60,5	-	-	-	-	25			
26	53,0	54,5	50,0	-	-	-	60,0	82,0	59,2	-	59,0	82,5	59,6	-	-	-	-	26			
28	53,0	54,0	50,0	36,7	-	-	58,5	79,0	57,5	-	58,0	79,5	58,0	-	-	-	-	28			
30	53,0	54,0	49,8	36,1	-	-	57,5	76,5	56,0	-	57,0	77,0	56,2	-	-	-	-	30			
34	52,0	53,0	49,0	34,6	-	-	54,8	71,5	53,0	-	55,0	72,0	53,2	-	-	-	-	34			
38	51,1	52,0	48,1	33,2	-	-	52,3	67,0	50,4	-	52,8	67,5	50,8	-	-	-	-	38			
42	50,5	51,0	47,1	32,0	-	-	50,0	63,1	48,2	-	50,5	63,8	48,5	-	-	-	-	42			
46	43,9	50,1	45,9	30,9	-	-	48,2	59,5	46,0	-	48,7	60,5	46,3	-	-	-	-	46			
50	38,5	48,9	44,4	29,9	-	-	46,4	56,5	44,0	-	46,9	57,1	44,3	-	-	-	-	50			
54	31,9	47,5	42,6	28,9	-	-	44,7	53,8	42,2	-	45,1	54,3	42,4	-	-	-	-	54			
58	26,6	46,1	40,9	28,0	-	-	43,0	51,5	40,5	-	43,5	52,0	40,8	-	-	-	-	58			
62	21,8	44,6	39,3	27,2	-	-	41,4	49,2	39,0	-	41,9	49,7	39,2	-	-	-	-	62			
66	17,6	43,2	37,9	26,4	-	-	40,0	47,1	37,6	-	40,5	47,6	37,8	-	-	-	-	66			
70	14,0	41,7	36,5	25,6	-	-	38,6	45,2	36,3	-	39,1	45,7	36,5	-	-	-	-	70			
74	10,8	40,3	35,3	25,0	-	-	37,4	43,4	35,1	-	37,9	43,9	35,3	-	-	-	-	74			
78	7,8	39,0	34,2	24,4	-	-	36,3	41,8	33,9	-	36,7	42,3	34,2	-	-	-	-	78			
82	5,2	37,8	33,1	23,8	-	-	35,2	40,3	32,9	-	35,6	40,7	33,2	-	-	-	-	82			
84	4,0	37,2	32,6	23,5	-	-	34,7	39,6	32,4	-	35,1	40,0	32,7	-	-	-	-	84			
86	-	36,6	32,1	23,3	-	-	34,2	38,9	31,9	-	34,6	39,3	32,2	-	-	-	-	86			
90	-	35,4	31,2	22,8	-	-	33,4	37,6	31,0	-	33,7	38,0	31,3	-	-	-	-	90			
94	-	34,2	30,4	22,3	-	-	32,6	36,4	30,2	-	32,9	36,8	30,5	-	-	-	-	94			
98	-	33,0	29,6	21,9	-	-	31,8	35,3	29,5	-	32,1	35,7	29,7	-	-	-	-	98			
102	-	31,8	28,9	21,6	-	-	31,0	34,3	28,8	-	31,3	34,7	29,0	-	-	-	-	102			
106	-	30,4	28,2	21,2	-	-	30,3	33,4	28,1	-	30,6	33,7	28,3	-	-	-	-	106			
110	-	29,1	27,6	20,9	-	-	29,7	32,5	27,5	-	29,9	32,8	27,7	-	-	-	-	110			
114	-	28,5	27,1	20,6	-	-	29,1	31,7	26,9	-	29,3	32,0	27,2	-	-	-	-	114			
118	-	27,8	26,5	20,4	-	-	28,5	30,9	26,5	-	28,7	31,3	26,7	-	-	-	-	118			
122	-	27,2	26,1	20,2	-	-	28,0	30,2	26,0	-	28,2	29,9	26,2	-	-	-	-	122			
125	-	26,8	25,7	20,1	-	-	27,6	29,7	25,7	-	27,8	28,8	25,9	-	-	-	-	125			
126	-	26,7	25,6	-	-	-	27,5	29,5	25,6	-	27,7	28,4	25,8	-	-	-	-	126			
130	-	26,2	25,3	-	-	-	27,1	27,6	25,2	-	27,0	26,8	25,4	-	-	-	-	130			
134	-	25,7	25,0	-	-	-	26,8	25,5	24,5	-	26,2	24,6	23,8	-	-	-	-	134			
138	-	25,3	24,7	-	-	-	26,5	23,4	23,5	-	25,3	22,5	22,3	-	-	-	-	138			
140	-	25,2	24,6	-	-	-	25,6	22,3	22,8	-	24,3	21,3	21,4	-	-	-	-	140			
142	-	24,9	-	-	-	-	-	21,3	-	-	23,4	20,2	20,4	-	-	-	-	142			
143	-	24,7	-	-	-	-	-	20,6	-	-	23,0	19,5	19,7	-	-	-	-	143			
144	-	24,6	-	-	-	-	-	20,0	-	-	-	18,9	-	-	-	-	-	144			
146	-	-	-	-	-	-	-	-	-	-	-	17,6	-	-	-	-	-	146			
147	-	-	-	-	-	-	-	-	-	-	-	17,0	-	-	-	-	-	147			

0 t
65 t
95 t
125 t
165 t
205 t
265 t
325 t

225 t														12 m x 12 m		9.8 m/s		360°		ISO															
144 m														147 m																					
LSL+LF_2				LSL+LF_4				LSL+LF_14				LSL+LF_4				LSL+LF_14																			
24 m																																			
0 t														0 t-325 t																					
15°		20°		30°		15°		20°		15°		20°		15°		20°		15°		20°															
m	t	t	t	t	t	t	t	t	t	t	t	t	t	t	t	t	t	t	t	t	t	m													
23	47,0	48,8	-	-	-	-	-	87,5	-	-	-	87,5	-	-	-	87,5	-	-	-	-	87,5	-	23												
24	46,9	48,6	-	-	-	-	-	86,0	-	-	-	86,5	-	-	-	86,5	-	-	-	-	86,5	-	24												
25	46,8	48,4	44,8	-	-	-	56,5	84,5	60,5	-	54,5	85,0	60,5	-	54,5	85,0	60,5	-	54,5	85,0	60,5	25													
26	46,7	48,2	44,6	-	-	-	56,0	83,0	59,6	-	54,5	83,5	60,0	-	54,5	83,5	60,0	-	54,5	83,5	60,0	26													
28	46,4	47,8	44,4	36,2	-	-	56,0	80,0	58,0	-	54,5	80,5	58,0	-	54,5	80,5	58,0	-	54,5	80,5	58,0	28													
30	46,2	47,4	44,1	35,6	-	-	55,5	77,2	56,5	-	54,5	77,7	56,5	-	54,5	77,7	56,5	-	54,5	77,7	56,5	30													
34	45,5	46,5	43,5	34,4	-	-	53,8	72,2	53,5	-	53,1	72,7	53,5	-	53,1	72,7	53,5	-	53,1	72,7	53,5	34													
38	44,8	45,6	42,8	33,2	-	-	52,0	68,0	50,9	-	51,6	68,5	51,2	-	51,6	68,5	51,2	-	51,6	68,5	51,2	38													
42	44,2	44,8	42,2	32,2	-	-	50,0	64,3	48,7	-	50,0	64,6	48,9	-	50,0	64,6	48,9	-	50,0	64,6	48,9	42													
46	41,5	43,9	41,4	31,1	-	-	48,2	61,0	46,5	-	48,4	61,0	46,8	-	48,4	61,0	46,8	-	48,4	61,0	46,8	46													
50	37,4	42,9	40,5	30,1	-	-	46,4	57,6	44,5	-	46,7	58,0	44,8	-	46,7	58,0	44,8	-	46,7	58,0	44,8	50													
54	30,8	41,9	39,4	29,1	-	-	44,7	54,8	42,7	-	45,1	55,3	43,0	-	45,1	55,3	43,0	-	45,1	55,3	43,0	54													
58	25,5	40,8	38,3	28,2	-	-	43,1	52,5	41,1	-	43,5	53,0	41,4	-	43,5	53,0	41,4	-	43,5	53,0	41,4	58													
62	20,7	39,7	37,2	27,4	-	-	41,7	50,1	39,5	-	42,1	50,5	39,8	-	42,1	50,5	39,8	-	42,1	50,5	39,8	62													
66	16,5	38,7	36,2	26,6	-	-	40,3	48,1	38,1	-	40,7	48,6	38,4	-	40,7	48,6	38,4	-	40,7	48,6	38,4	66													
70	12,9	37,5	35,1	25,9	-	-	38,9	46,1	36,8	-	39,3	46,6	37,1	-	39,3	46,6	37,1	-	39,3	46,6	37,1	70													
74	9,6	36,4	34,1	25,2	-	-	37,7	44,3	35,6	-	38,1	44,8	35,9	-	38,1	44,8	35,9	-	38,1	44,8	35,9	74													
78	6,6	35,4	33,1	24,6	-	-	36,6	42,7	34,4	-	37,0	43,1	34,7	-	37,0	43,1	34,7	-	37,0	43,1	34,7	78													
82	4,0	34,4	32,2	24,0	-	-	35,5	41,2	33,4	-	35,9	41,6	33,7	-	35,9	41,6	33,7	-	35,9	41,6	33,7	82													
86	-	33,3	31,3	23,5	-	-	34,5	39,8	32,5	-	34,9	40,2	32,7	-	34,9	40,2	32,7	-	34,9	40,2	32,7	86													
90	-	32,3	30,4	23,0	-	-	33,7	38,4	31,6	-	34,0	38,8	31,8	-	34,0	38,8	31,8	-	34,0	38,8	31,8	90													
94	-	31,3	29,4	22,5	-	-	32,9	37,2	30,7	-	33,2	37,6	31,0	-	33,2	37,6	31,0	-	33,2	37,6	31,0	94													
98	-	30,2	28,6	22,1	-	-	32,2	36,1	30,0	-	32,5	36,5	30,2	-	32,5	36,5	30,2	-	32,5	36,5	30,2	98													
102	-	29,3	27,7	21,8	-	-	31,5	35,1	29,2	-	31,8	35,5	29,4	-	31,8	35,5	29,4	-	31,8	35,5	29,4	102													
106	-	28,2	26,6	21,4	-	-	30,8	34,1	28,6	-	31,0	34,5	28,8	-	31,0	34,5	28,8	-	31,0	34,5	28,8	106													
110	-	27,0	25,5	21,1	-	-	30,1	33,2	28,0	-	30,4	33,5	28,2	-	30,4	33,5	28,2	-	30,4	33,5	28,2	110													
114	-	25,8	25,1	20,8	-	-	29,5	32,4	27,4	-	29,8	32,7	27,6	-	29,8	32,7	27,6	-	29,8	32,7	27,6	114													
118	-	25,2	24,7	20,5	-	-	28,9	31,6	26,9	-	29,2	31,9	27,1	-	29,2	31,9	27,1	-	29,2	31,9	27,1	118													
122	-	24,6	24,5	20,3	-	-	28,4	30,4	26,4	-	28,6	30,0	26,5	-	28,6	30,0	26,5	-	28,6	30,0	26,5	122													
126	-	24,0	24,3	20,1	-	-	27,9	28,3	25,9	-	28,1	27,5	25,9	-	28,1	27,5	25,9	-	28,1	27,5	25,9	126													
130	-	23,4	24,1	20,0	-	-	27,0	26,2	25,5	-	27,1	25,1	25,3	-	27,1	25,1	25,3	-	27,1	25,1	25,3	130													
134	-	22,9	24,0	-	-	-	25,8	24,0	23,6	-	25,7	22,8	23,1	-	25,7	22,8	23,1	-	25,7	22,8	23,1	134													
138	-	22,5	24,0	-	-	-	24,6	21,8	21,7	-	24,1	20,7	21,0	-	24,1	20,7	21,0	-	24,1	20,7	21,0	138													
142	-	22,0	24,0	-	-	-	22,8	19,7	19,8	-	22,5	18,4	18,8	-	22,5	18,4	18,8	-	22,5	18,4	18,8	142													
145	-	21,6	24,0	-	-	-	21,3	17,8	18,0	-	20,7	16,5	16,8	-	20,7	16,5	16,8	-	20,7	16,5	16,8	145													
146	-	21,4	-	-	-	-	-	17,1	-	-	20,0	15,9	16,2	-	20,0	15,9	16,2	-	20,0	15,9	16,2	146													
147	-	21,2	-	-	-	-	-	16,5	-	-	19,4	15,3	15,5	-	19,4	15,3	15,5	-	19,4	15,3	15,5	147													
148	-	21,0	-	-	-	-	-	15,9	-	-	-	14,7	14,9	-	-	14,7	14,9	-	-	14,7	14,9	148													
150	-	20,6	-	-	-	-	-	14,6	-	-	-	13,5	-	-	-	13,5	-	-	-	13,5	-	150													
152	-	-	-	-	-	-	-	-	-	-	-	12,3	-	-	-	12,3	-	-	-	12,3	-	152													

	0t	65t	95t	125t	165t	205t	265t	325t
--	----	-----	-----	------	------	------	------	------

225 t		12 m x 12 m												9.8 m/s		360°		ISO									
150 m		153 m				156 m				159 m				162 m		165 m											
LSL+LF_4		LSL+LF_14		LSL+LF_4		LSL+LF_14		LSL+LF_4		LSL+LF_14		LSL+LF_4		LSL+LF_14													
0 t		0 t-325 t												0 t		0 t-325 t											
20°		15°		20°		15°		20°		15°		20°		15°		20°		15°		20°							
m	t	t	t	t	t	t	t	t	t	t	t	t	t	t	t	t	t	t	t	t	m						
23	-	-	87,0	-	-	-	85,0	-	-	-	-	-	-	-	-	-	-	-	-	-	23						
24	-	-	86,5	-	-	-	85,0	-	-	-	82,0	-	-	-	79,0	-	76,5	-	-	-	24						
25	46,3	48,0	85,1	-	-	46,5	84,0	-	-	-	81,6	-	-	78,8	-	76,3	-	73,5	-	-	25						
26	46,3	47,9	83,7	60,0	-	46,4	83,0	60,0	43,0	44,5	81,2	60,5	-	43,0	78,7	60,5	76,2	-	73,3	-	26						
27	46,3	47,8	82,3	59,2	-	46,3	82,0	59,2	43,0	44,4	80,8	59,5	-	42,9	78,6	59,5	76,1	60,0	73,1	60,0	27						
28	46,3	47,7	81,0	58,5	-	46,2	81,0	58,5	43,0	44,3	80,5	58,5	-	42,8	78,5	59,0	76,0	59,0	73,0	59,0	28						
30	46,3	47,5	78,2	57,0	-	46,0	78,5	57,0	42,9	44,1	78,5	57,0	-	42,6	77,5	57,5	75,5	57,5	72,5	57,7	30						
34	45,9	46,9	73,2	54,0	-	45,4	73,7	54,2	42,5	43,6	74,2	54,2	-	42,2	74,5	54,7	73,7	54,7	71,2	55,0	34						
38	45,4	46,2	69,0	51,2	-	44,8	69,5	51,7	42,1	43,1	70,0	51,7	-	41,7	70,5	52,2	70,7	52,2	69,2	52,5	38						
42	44,8	45,5	65,1	49,0	-	44,2	65,6	49,4	41,6	42,5	66,1	49,5	-	41,1	66,6	49,9	67,1	50,0	66,6	50,4	42						
46	41,0	44,7	61,5	47,1	-	43,5	62,0	47,3	39,2	41,8	62,5	47,6	-	40,5	63,0	47,8	63,5	48,0	64,0	48,3	46						
50	36,6	43,7	58,5	45,1	-	42,7	59,0	45,3	34,9	41,1	59,5	45,6	-	39,8	60,0	45,8	60,5	46,1	61,0	46,3	50						
54	29,8	42,5	55,8	43,3	-	41,8	56,3	43,5	28,1	40,4	56,6	43,8	-	39,2	57,1	44,0	57,6	44,3	58,1	44,5	54						
58	24,4	41,2	53,5	41,6	-	40,8	53,5	41,9	22,6	39,6	54,0	42,2	-	38,5	54,5	42,4	55,0	42,7	55,5	42,9	58						
62	19,4	40,0	51,1	40,1	-	39,8	51,5	40,4	17,6	38,8	52,0	40,6	-	37,9	52,2	40,9	52,7	41,1	53,2	41,4	62						
66	15,0	38,9	49,0	38,6	-	38,8	49,5	39,0	13,2	38,0	49,9	39,2	-	37,3	50,1	39,5	50,6	39,7	51,0	40,0	66						
70	11,3	37,8	47,0	37,4	-	37,8	47,5	37,6	9,5	37,2	47,9	37,9	-	36,6	48,4	38,2	48,8	38,4	49,2	38,7	70						
74	7,9	36,8	45,2	36,2	-	37,0	45,7	36,4	6,1	36,5	46,1	36,7	-	36,0	46,6	37,0	47,0	37,2	47,4	37,5	74						
77	5,6	36,1	44,0	35,3	-	36,3	44,4	35,5	3,8	35,9	44,8	35,8	-	35,5	45,3	36,1	45,7	36,3	46,1	36,6	77						
78	4,9	35,8	43,6	35,0	-	36,1	44,0	35,3	-	35,8	44,4	35,5	-	35,4	44,9	35,8	45,3	36,0	45,7	36,3	78						
80	3,5	35,3	42,8	34,5	-	35,7	43,2	34,8	-	35,4	43,6	35,0	-	35,1	44,1	35,3	44,5	35,5	44,9	35,7	80						
82	-	34,9	42,0	34,0	-	35,3	42,4	34,2	-	35,0	42,9	34,5	-	34,8	43,3	34,7	43,7	35,0	44,1	35,2	82						
86	-	34,1	40,6	33,0	-	34,5	41,0	33,2	-	34,3	41,4	33,5	-	34,1	41,8	33,7	42,2	34,0	42,6	34,2	86						
90	-	33,3	39,2	32,1	-	33,7	39,7	32,3	-	33,7	40,0	32,6	-	33,5	40,4	32,8	40,8	33,0	41,2	33,3	90						
94	-	32,5	38,0	31,2	-	32,9	38,4	31,5	-	32,9	38,8	31,7	-	32,8	39,2	32,0	39,6	32,2	39,9	32,4	94						
98	-	31,8	36,9	30,4	-	32,2	37,2	30,7	-	32,0	37,6	30,9	-	32,0	38,0	31,2	38,4	31,4	38,7	31,6	98						
102	-	31,1	35,8	29,7	-	31,5	36,2	29,9	-	31,4	36,5	30,1	-	31,4	36,9	30,4	37,2	30,6	37,6	30,8	102						
106	-	29,7	34,8	29,0	-	30,8	35,2	29,2	-	30,6	35,5	29,5	-	30,4	35,9	29,7	36,2	29,9	36,6	30,1	106						
110	-	28,8	33,9	28,4	-	30,2	34,2	28,6	-	29,7	34,5	28,8	-	29,9	34,9	29,0	35,0	29,2	34,2	29,4	110						
114	-	28,1	33,0	27,8	-	29,7	33,3	28,0	-	29,0	33,6	28,2	-	29,2	33,4	28,4	32,9	28,6	31,1	27,9	114						
118	-	27,0	32,2	27,3	-	29,3	32,6	27,5	-	28,5	32,6	27,6	-	28,2	31,3	27,8	29,9	28,0	27,4	25,9	118						
122	-	26,8	31,3	26,7	-	28,9	30,4	26,9	-	28,0	29,9	27,0	-	27,5	28,7	26,0	26,9	25,8	23,8	23,8	122						
126	-	26,7	29,2	26,3	-	28,5	28,0	26,2	-	27,6	27,3	25,9	-	26,6	26,1	24,0	24,0	23,3	20,4	21,3	126						
130	-	26,6	26,8	25,9	-	28,0	25,6	25,3	-	27,2	24,9	24,4	-	25,7	23,7	21,6	21,2	20,4	17,1	18,5	130						
134	-	25,5	24,5	24,4	-	26,8	23,3	23,5	-	26,3	22,7	22,8	-	24,7	20,3	19,3	18,4	17,5	13,9	14,9	134						
138	-	24,3	22,4	22,6	-	25,0	21,4	21,7	-	24,9	20,4	21,0	-	23,7	16,8	16,9	15,2	14,7	10,9	11,5	138						
142	-	23,1	20,7	20,9	-	23,1	19,8	20,0	-	22,8	17,7	19,2	-	21,7	13,6	14,6	11,7	11,9	8,1	8,3	142						
146	-	21,8	18,6	18,9	-	21,0	17,4	17,8	-	20,5	15,1	16,2	-	19,6	10,6	11,8	8,5	9,2	5,3	5,3	146						
148	-	20,5	17,6	17,9	-	19,8	16,3	16,8	-	19,3	13,8	14,7	-	18,5	9,1	10,5	6,9	7,9	4,0	3,9	148						
150	-	19,3	16,4	16,6	-	18,7	15,1	15,5	-	18,1	12,5	13,2	-	17,4	7,8	9,0	5,5	6,5	-	-	150						
153	-	-	14,6	-	-	16,9	13,4	13,7	-	16,3	10,5	11,0	-	15,7	6,0	6,9	3,6	4,6	-	-	153						
154	-	-	14,1	-	-	-	12,9	-	-	15,7	9,9	10,3	-	15,1	5,4	6,2	-	4,0	-	-	154						
155	-	-	13,5	-	-	-	12,3	-	-	15,2	9,3	9,5	-	14,5	4,8	5,5	-	-	-	-	155						
157	-	-	-	-	-	-	11,2	-	-	-	8,1	-	-	13,5	3,7	4,1	-	-	-	-	157						
158	-	-	-	-	-	-	-	-	-	-	7,5	-	-	-	-	-	-	-	-	-	158						
160	-	-	-	-	-	-	-	-	-	-	6,3	-	-	-	-	-	-	-	-	-	160						



225 t		12 m x 12 m												9.8 m/s			360°			ISO										
		72 m				78 m				84 m				90 m			96 m													
		LSL+LF_2																												
		36 m																												
		0 t			0 t-325 t			0 t			0 t-325 t			0 t			0 t-325 t			0 t			0 t-325 t							
		15°			20°			30°			15°			20°			30°			15°			20°			30°				
m	t	t	t	t	t	t	t	t	t	t	t	t	t	t	t	t	t	t	t	t	t	t	t	t	t	t	t	m		
20	53,5	53,5	-	-	-	-	-	-	-	-	-	-	-	-	-	-	-	-	-	-	-	-	-	-	-	-	-	20		
21	52,0	52,2	-	-	52,5	52,5	-	-	52,5	53,0	-	-	-	-	-	-	-	-	-	-	-	-	-	-	-	-	-	21		
22	50,5	51,0	-	-	51,0	51,5	-	-	51,5	51,5	-	-	51,5	52,0	-	-	-	-	-	-	-	-	-	-	-	-	-	22		
23	49,3	49,7	39,4	-	49,8	50,2	-	-	50,3	50,4	-	-	50,5	50,9	-	-	-	50,5	51,0	-	-	-	-	-	-	-	-	23		
24	48,2	48,5	38,6	-	48,7	49,0	38,8	-	49,1	49,4	38,9	-	49,5	49,9	-	-	49,7	50,0	-	-	-	-	-	-	-	-	-	24		
25	47,1	47,4	37,7	-	47,6	47,9	38,0	-	48,0	48,3	38,1	-	48,4	48,8	38,3	-	48,7	49,0	38,4	-	-	-	-	-	-	-	-	25		
26	46,0	46,3	36,9	-	46,5	46,8	37,2	-	47,0	47,3	37,4	-	47,4	47,8	37,6	-	47,7	48,0	37,7	-	-	-	-	-	-	-	-	26		
28	44,0	44,2	35,5	-	44,6	44,9	35,8	-	45,1	45,4	36,0	-	45,6	45,9	36,3	-	45,8	46,1	36,4	-	-	-	-	-	-	-	-	28		
29	43,0	43,2	34,8	22,6	43,7	43,9	35,1	22,7	44,2	44,5	35,4	-	44,7	45,0	35,7	-	45,0	45,3	35,8	-	-	-	-	-	-	-	-	29		
30	42,1	42,3	34,1	22,3	42,8	43,0	34,5	22,3	43,3	43,6	34,8	22,3	43,9	44,2	35,1	22,3	44,2	44,5	35,2	-	-	-	-	-	-	-	-	30		
31	41,2	41,4	33,5	21,9	41,9	42,1	33,9	21,9	42,5	42,7	34,2	22,0	43,1	43,4	34,5	22,0	43,4	43,7	34,6	22,0	-	-	-	-	-	-	-	31		
34	38,6	38,8	31,7	20,9	39,4	39,6	32,1	21,0	40,1	40,3	32,5	21,1	40,7	41,0	32,9	21,1	41,2	41,5	33,0	21,1	-	-	-	-	-	-	-	34		
38	35,5	35,7	29,4	19,7	36,4	36,6	30,0	19,9	37,1	37,3	30,4	20,0	37,8	38,1	30,8	20,1	38,5	38,7	31,1	20,1	-	-	-	-	-	-	-	38		
42	32,8	32,9	27,4	18,7	33,7	33,8	28,0	18,9	34,5	34,6	28,5	19,0	35,2	35,4	28,9	19,1	35,9	36,1	29,3	19,2	-	-	-	-	-	-	-	42		
46	30,6	30,7	25,7	17,7	31,4	31,6	26,3	17,9	32,2	32,4	26,8	18,1	33,0	33,2	27,3	18,2	33,6	33,8	27,7	18,3	-	-	-	-	-	-	-	46		
50	28,7	28,8	24,2	16,9	29,5	29,6	24,8	17,1	30,2	30,4	25,3	17,3	31,0	31,2	25,8	17,4	31,5	31,7	26,2	17,5	-	-	-	-	-	-	-	50		
54	27,2	27,2	22,9	16,1	27,9	28,0	23,5	16,3	28,5	28,7	24,0	16,5	29,2	29,4	24,5	16,7	29,7	29,9	24,8	16,8	-	-	-	-	-	-	-	54		
58	25,6	25,6	21,7	15,4	26,5	26,5	22,3	15,7	27,2	27,3	22,8	15,9	27,8	28,0	23,4	16,1	28,2	28,3	23,6	16,2	-	-	-	-	-	-	-	58		
62	24,2	24,2	20,6	14,8	25,1	25,1	21,2	15,1	25,9	25,9	21,8	15,3	26,6	26,7	22,3	15,5	26,9	27,0	22,6	15,6	-	-	-	-	-	-	-	62		
66	22,9	22,9	19,6	14,3	23,7	23,7	20,2	14,5	24,6	24,6	20,8	14,7	25,4	25,4	21,3	14,9	25,7	25,8	21,7	15,0	-	-	-	-	-	-	-	66		
70	21,7	21,7	18,7	13,7	22,5	22,5	19,3	14,0	23,4	23,4	19,8	14,2	24,2	24,2	20,4	14,4	24,5	24,7	20,8	14,5	-	-	-	-	-	-	-	70		
74	20,7	20,7	17,9	13,3	21,5	21,5	18,5	13,5	22,3	22,3	19,0	13,8	22,8	23,0	19,6	14,0	22,8	23,7	20,0	14,1	-	-	-	-	-	-	-	74		
78	19,8	19,8	17,2	12,9	20,6	20,6	17,8	13,1	21,3	21,3	18,3	13,4	21,4	22,0	18,8	13,6	20,5	22,7	19,3	13,7	-	-	-	-	-	-	-	78		
82	19,0	19,0	16,6	12,5	19,7	19,7	17,1	12,7	19,9	20,4	17,6	13,0	18,8	21,1	18,1	13,2	17,9	21,8	18,6	13,3	-	-	-	-	-	-	-	82		
86	18,2	18,2	16,0	12,2	18,5	18,9	16,5	12,4	18,0	19,6	17,0	12,6	16,3	20,3	17,5	12,9	15,4	21,0	18,0	12,9	-	-	-	-	-	-	-	86		
88	17,9	17,9	15,8	12,1	17,7	18,6	16,2	12,3	16,9	19,2	16,7	12,5	15,2	19,9	17,2	12,7	14,3	20,6	17,7	12,8	-	-	-	-	-	-	-	88		
90	17,6	17,6	15,6	-	16,9	18,3	16,0	12,2	15,8	18,9	16,5	12,4	14,1	19,5	16,9	12,6	13,2	20,2	17,4	12,7	-	-	-	-	-	-	-	90		
92	16,9	17,3	15,4	-	15,9	18,0	15,8	12,1	14,8	18,6	16,2	12,2	13,1	19,1	16,6	12,4	12,2	19,8	17,1	12,5	-	-	-	-	-	-	-	92		
94	16,3	17,0	15,2	-	14,9	17,7	15,6	-	13,8	18,3	15,9	12,1	12,1	18,8	16,4	12,3	11,2	19,4	16,8	12,4	-	-	-	-	-	-	-	94		
96	15,7	16,8	15,0	-	14,0	17,4	15,4	-	12,9	18,0	15,7	12,0	11,1	18,5	16,2	12,2	10,2	19,1	16,6	12,3	-	-	-	-	-	-	-	96		
98	14,8	16,6	-	-	13,1	17,1	15,2	-	12,0	17,7	15,5	-	10,2	18,2	15,9	12,1	9,3	18,8	16,3	12,2	-	-	-	-	-	-	-	98		
99	14,4	16,5	-	-	12,7	17,0	15,1	-	11,6	17,6	15,4	-	9,8	18,1	15,8	12,0	8,9	18,6	16,2	12,1	-	-	-	-	-	-	-	99		
101	-	-	-	-	11,8	16,8	14,9	-	10,7	17,3	15,2	-	8,9	17,8	15,6	11,9	8,0	18,3	16,0	12,0	-	-	-	-	-	-	-	101		
102	-	-	-	-	11,4	16,7	-	-	10,3	17,2	15,2	-	8,5	17,7	15,5	-	7,6	18,2	15,9	12,0	-	-	-	-	-	-	-	102		
104	-	-	-	-	10,6	16,5	-	-	9,5	16,9	15,0	-	7,7	17,4	15,3	-	6,8	17,9	15,7	11,9	-	-	-	-	-	-	-	104		
105	-	-	-	-	-	-	-	-	9,1	16,8	14,9	-	7,3	17,3	15,2	-	6,4	17,8	15,6	11,9	-	-	-	-	-	-	-	105		
106	-	-	-	-	-	-	-	-	8,7	16,7	14,9	-	6,9	17,2	15,1	-	6,0	17,6	15,5	-	-	-	-	-	-	-	-	106		
109	-	-	-	-	-	-	-	-	7,6	16,4	-	-	5,8	16,9	14,9	-	4,9	17,3	15,2	-	-	-	-	-	-	-	-	109		
110	-	-	-	-	-	-	-	-	-	-	-	-	5,5	16,8	14,8	-	4,6	17,2	15,2	-	-	-	-	-	-	-	-	110		
111	-	-	-	-	-	-	-	-	-	-	-	-	5,2	16,7	14,8	-	4,2	17,1	15,1	-	-	-	-	-	-	-	-	111		
113	-	-	-	-	-	-	-	-	-	-	-	-	4,5	16,5	-	-	3,6	16,9	15,0	-	-	-	-	-	-	-	-	113		
114	-	-	-	-	-	-	-	-	-	-	-	-	4,2	16,4	-	-	-	16,8	14,9	-	-	-	-	-	-	-	-	114		
116	-	-	-	-	-	-	-	-	-	-	-	-	-	-	-	-	-	16,6	14,8	-	-	-	-	-	-	-	-	116		
118	-	-	-	-	-	-	-	-	-	-	-	-	-	-	-	-	-	16,4	-	-	-	-	-	-	-	-	-	118		
120	-	-	-	-	-	-	-	-	-	-	-	-	-	-	-	-	-	16,3	-	-	-	-	-	-	-	-	-	120		



0t
65t
95t
125t
165t
205t
265t
325t

225 t		12 m x 12 m										9.8 m/s			360°			ISO				
		102 m			108 m			114 m			120 m			126 m								
		LSL+LF_2																				
		36 m																				
		0 t			0 t-325 t			0 t			0 t-325 t			0 t			0 t-325 t					
		15°			20°			30°			15°			20°			30°					
m	t	t	t	t	t	t	t	t	t	t	t	t	t	t	t	t	t	t	t	t	m	
23	51,0	51,0	-	-	-	-	-	-	-	-	-	-	-	-	-	-	-	-	-	-	23	
24	50,0	50,0	-	-	50,0	50,5	-	-	50,0	50,5	-	-	-	-	-	-	-	-	-	-	24	
25	49,0	49,2	-	-	49,2	49,6	-	-	49,3	49,7	-	-	-	-	-	-	-	-	-	-	25	
26	48,0	48,4	37,9	-	48,4	48,7	-	-	48,7	49,0	-	-	-	48,5	49,4	-	-	-	45,3	47,5	-	26
27	47,1	47,5	37,2	-	47,5	47,8	37,4	-	47,9	48,1	37,5	-	-	47,3	47,9	-	-	-	44,9	46,5	-	27
28	46,3	46,6	36,6	-	46,7	47,0	36,8	-	47,1	47,3	36,9	-	-	46,7	47,2	36,7	-	-	44,6	46,1	36,4	28
30	44,6	45,0	35,5	-	45,0	45,4	35,6	-	45,5	45,8	35,8	-	-	45,3	45,7	35,7	-	-	44,0	45,2	35,5	30
31	43,9	44,2	34,9	22,0	44,3	44,6	35,1	-	44,8	45,0	35,3	-	-	44,6	45,0	35,2	-	-	43,5	44,5	35,0	31
32	43,2	43,5	34,4	21,7	43,6	43,9	34,6	21,7	44,1	44,3	34,8	21,7	44,0	44,4	34,8	-	-	-	43,1	43,9	34,6	32
33	42,5	42,8	33,9	21,4	42,9	43,2	34,1	21,4	43,4	43,7	34,4	21,4	43,4	43,7	34,3	21,3	42,6	43,3	42,2	42,7	34,2	33
34	41,8	42,0	33,4	21,2	42,2	42,5	33,6	21,2	42,7	43,0	33,9	21,2	42,7	43,1	33,9	21,1	42,2	42,7	42,7	42,7	33,7	34
38	39,1	39,3	31,5	20,2	39,6	39,8	31,8	20,2	40,2	40,5	32,1	20,2	40,4	40,6	32,2	20,2	40,2	40,5	40,5	40,5	32,1	38
42	36,6	36,8	29,7	19,3	37,2	37,4	30,1	19,4	37,9	38,1	30,5	19,4	38,2	38,4	30,6	19,4	38,1	38,3	38,3	38,3	30,6	42
46	34,4	34,6	28,1	18,5	35,0	35,2	28,5	18,6	35,7	35,9	28,9	18,6	36,2	36,4	29,2	18,7	36,1	36,3	36,3	36,3	29,2	46
50	32,3	32,5	26,7	17,7	33,0	33,2	27,1	17,8	33,7	33,9	27,5	17,9	34,2	34,5	27,8	18,0	34,2	34,4	34,4	34,4	27,8	50
54	30,5	30,7	25,3	17,0	31,2	31,4	25,8	17,1	31,9	32,1	26,2	17,3	32,4	32,7	26,6	17,4	32,4	32,6	32,6	32,6	26,6	54
58	28,9	29,1	24,1	16,3	29,6	29,8	24,6	16,5	29,8	30,4	25,0	16,6	30,1	31,0	25,4	16,8	29,9	31,0	31,0	31,0	25,4	58
62	27,5	27,8	23,1	15,7	27,6	28,3	23,5	15,9	27,4	28,9	23,9	16,0	27,2	29,5	24,3	16,2	27,0	29,5	29,5	29,5	24,3	62
66	26,3	26,6	22,2	15,2	26,1	27,1	22,6	15,4	24,4	27,6	22,9	15,5	23,4	28,1	23,3	15,6	22,7	28,1	28,1	28,1	23,3	66
70	23,8	25,4	21,4	14,7	22,5	26,0	21,7	14,8	20,7	26,5	22,1	15,0	19,7	26,9	22,4	15,1	19,0	26,9	26,9	26,9	22,4	70
74	21,3	24,4	20,6	14,3	19,1	24,9	20,9	14,4	17,4	25,5	21,3	14,5	16,3	25,8	21,6	14,6	15,6	25,9	25,9	25,9	21,6	74
78	18,8	23,4	19,8	13,9	16,1	23,9	20,2	14,0	14,4	24,5	20,5	14,1	13,3	24,8	20,8	14,2	12,6	24,9	24,9	24,9	20,9	78
82	16,1	22,4	19,0	13,5	13,9	23,0	19,4	13,6	12,2	23,5	19,8	13,7	10,7	23,9	20,1	13,8	10,0	24,0	24,0	24,0	20,2	82
86	13,6	21,6	18,4	13,1	11,7	22,2	18,8	13,2	9,9	22,7	19,2	13,4	8,4	23,0	19,4	13,5	7,7	23,2	23,2	23,2	19,5	86
90	11,4	20,8	17,8	12,8	9,4	21,4	18,2	13,0	7,7	21,9	18,6	13,1	6,6	22,2	18,8	13,2	5,9	22,4	22,4	22,4	18,9	90
94	9,4	20,0	17,2	12,5	7,4	20,6	17,6	12,7	5,7	21,1	18,0	12,8	4,6	21,5	18,3	12,8	3,8	21,6	21,6	21,6	18,3	94
96	8,5	19,7	17,0	12,4	6,5	20,3	17,4	12,6	4,7	20,8	17,8	12,7	3,6	21,1	18,0	12,7	-	21,3	21,3	21,3	18,1	96
98	7,6	19,4	16,7	12,3	5,6	19,9	17,1	12,4	3,8	20,5	17,5	12,5	-	20,8	17,7	12,6	-	20,9	20,9	20,9	17,8	98
102	5,9	18,8	16,3	12,1	3,8	19,3	16,6	12,2	-	19,8	17,0	12,3	-	20,2	17,3	12,4	-	20,3	20,3	20,3	17,4	102
106	4,3	18,2	15,9	11,9	-	18,7	16,2	12,0	-	19,2	16,5	12,1	-	19,6	16,9	12,2	-	19,7	19,7	19,7	17,0	106
108	3,5	17,9	15,7	11,9	-	18,4	16,0	12,0	-	18,9	16,3	12,0	-	19,3	16,7	12,1	-	19,5	19,5	19,5	16,8	108
109	-	17,7	15,6	11,8	-	18,2	15,9	11,9	-	18,7	16,2	11,9	-	19,1	16,6	12,0	-	19,3	19,3	19,3	16,7	109
110	-	17,6	15,5	-	-	18,1	15,8	11,9	-	18,6	16,1	11,9	-	19,0	16,5	12,0	-	19,2	19,2	19,2	16,6	110
114	-	17,2	15,2	-	-	17,7	15,5	11,7	-	18,1	15,8	11,8	-	18,6	16,1	11,8	-	18,7	18,7	18,7	16,2	114
118	-	16,8	14,9	-	-	17,2	15,1	-	-	17,7	15,4	11,7	-	18,1	15,7	11,7	-	18,3	18,3	18,3	15,8	118
121	-	16,6	14,7	-	-	16,9	14,9	-	-	17,4	15,2	-	-	17,8	15,5	11,6	-	18,0	18,0	18,0	15,6	121
122	-	16,5	-	-	-	16,8	14,9	-	-	17,3	15,1	-	-	17,7	15,4	11,6	-	17,9	17,9	17,9	15,5	122
123	-	16,4	-	-	-	16,8	14,8	-	-	17,2	15,1	-	-	17,6	15,3	11,6	-	17,8	17,8	17,8	15,5	123
125	-	16,3	-	-	-	16,6	14,7	-	-	17,0	14,9	-	-	17,4	15,1	-	-	17,6	17,6	17,6	15,4	125
126	-	-	-	-	-	16,5	14,7	-	-	16,9	14,9	-	-	17,3	15,1	-	-	17,5	17,5	17,5	15,4	126
127	-	-	-	-	-	16,4	-	-	-	16,8	14,8	-	-	17,2	15,0	-	-	17,4	17,4	17,4	15,3	127
130	-	-	-	-	-	16,2	-	-	-	16,5	14,7	-	-	16,9	14,9	-	-	17,2	17,2	17,2	15,1	130
131	-	-	-	-	-	-	-	-	-	16,5	14,6	-	-	16,8	14,8	-	-	17,1	17,1	17,1	15,0	131
134	-	-	-	-	-	-	-	-	-	16,2	-	-	-	16,6	14,7	-	-	16,9	16,9	16,9	14,8	134
135	-	-	-	-	-	-	-	-	-	16,2	-	-	-	16,5	14,6	-	-	16,8	16,8	16,8	14,8	135
136	-	-	-	-	-	-	-	-	-	-	-	-	-	16,4	14,6	-	-	16,7	16,7	16,7	14,7	136
138	-	-	-	-	-	-	-	-	-	-	-	-	-	16,3	-	-	-	16,6	16,6	16,6	14,6	138
140	-	-	-	-	-	-	-	-	-	-	-	-	-	16,2	-	-	-	16,4	16,4	16,4	14,5	140
142	-	-	-	-	-	-	-	-	-	-	-	-	-	-	-	-	-	16,3	16,3	16,3	14,5	142
146	-	-	-	-	-	-	-	-	-	-	-	-	-	-	-	-	-	16,1	16,1	16,1	-	146

0 t
65 t
95 t
125 t
165 t
205 t
265 t
325 t

225 t		12 m x 12 m						9.8 m/s		360°		ISO	
132 m		138 m						144 m		LSL+LF_2			
0 t		0 t-325 t			0 t-325 t			0 t-325 t		0 t-325 t			
15°		20°		30°		15°		20°		30°		15°	
m	t	t	t	t	t	t	t	t	t	t	t	t	m
26	41,5	43,7	-	-	37,4	39,1	-	-	-	-	-	-	26
27	41,5	43,6	-	-	37,4	39,0	-	-	33,5	34,7	-	-	27
28	41,5	43,5	-	-	37,4	39,0	-	-	33,5	34,5	-	-	28
29	41,5	43,4	35,6	-	37,4	38,9	33,8	-	33,4	34,4	-	-	29
30	41,5	43,3	35,2	-	37,4	38,8	33,6	-	33,4	34,3	30,5	-	30
34	41,0	41,9	33,6	20,9	37,3	38,3	32,7	-	33,2	33,9	30,1	-	34
35	40,9	41,6	33,2	20,7	37,3	38,2	32,5	20,5	33,1	33,8	30,0	20,3	35
38	39,8	40,3	32,1	20,1	36,8	37,5	31,7	20,0	32,8	33,4	29,5	19,8	38
42	38,0	38,3	30,7	19,4	35,8	36,3	30,3	19,3	32,3	32,9	28,9	19,0	42
46	36,2	36,4	29,3	18,7	34,6	35,1	28,9	18,5	31,7	32,1	28,0	18,3	46
50	34,4	34,6	28,0	18,0	33,5	33,9	27,7	17,9	31,1	31,4	27,1	17,7	50
54	32,7	32,9	26,8	17,4	32,4	32,7	26,5	17,3	30,6	30,7	26,2	17,1	54
58	29,3	31,3	25,6	16,8	28,6	31,4	25,3	16,7	27,0	29,7	25,3	16,5	58
62	26,0	29,9	24,5	16,2	25,4	30,2	24,3	16,1	24,3	28,8	24,4	16,0	62
66	21,6	28,5	23,5	15,7	21,0	29,0	23,4	15,6	19,9	27,8	23,5	15,5	66
70	17,9	27,3	22,6	15,1	17,3	27,8	22,5	15,1	16,2	26,8	22,7	15,0	70
74	14,5	26,1	21,8	14,7	13,9	26,7	21,7	14,7	12,8	25,9	21,9	14,6	74
78	11,5	25,1	21,0	14,3	10,9	25,5	21,0	14,3	9,8	24,9	21,1	14,2	78
82	8,9	24,3	20,3	13,9	8,2	24,4	20,4	13,9	7,1	23,9	20,3	13,8	82
86	6,4	23,5	19,7	13,5	5,7	23,6	19,8	13,5	4,6	23,0	19,6	13,5	86
87	5,9	23,4	19,5	13,4	5,2	23,4	19,6	13,4	4,0	22,8	19,5	13,4	87
90	4,2	22,8	19,1	13,2	3,5	22,9	19,2	13,2	-	22,3	19,2	13,2	90
91	3,6	22,6	18,9	13,1	-	22,7	19,0	13,2	-	22,1	19,0	13,1	91
94	-	22,1	18,5	12,9	-	22,3	18,6	12,9	-	21,6	18,6	12,8	94
98	-	21,4	18,0	12,6	-	21,6	18,1	12,6	-	20,9	18,1	12,5	98
102	-	20,7	17,5	12,4	-	21,0	17,6	12,4	-	20,3	17,7	12,3	102
106	-	20,1	17,1	12,2	-	20,3	17,2	12,2	-	19,6	17,2	12,1	106
110	-	19,4	16,7	12,0	-	19,6	16,8	12,0	-	19,0	16,8	11,9	110
114	-	18,9	16,3	11,8	-	19,1	16,4	11,8	-	18,3	16,3	11,7	114
118	-	18,5	15,9	11,6	-	18,6	16,0	11,6	-	17,6	16,0	11,5	118
122	-	18,1	15,7	11,5	-	18,2	15,7	11,5	-	16,8	15,7	11,4	122
126	-	17,7	15,4	11,4	-	17,8	15,5	11,4	-	16,5	15,5	11,3	126
130	-	17,3	15,2	11,3	-	17,4	15,3	11,3	-	16,3	15,2	11,2	130
132	-	17,2	15,1	11,3	-	17,3	15,2	11,3	-	16,2	15,1	11,2	132
134	-	17,1	15,0	-	-	17,2	15,1	11,2	-	16,1	15,0	11,1	134
136	-	16,9	14,9	-	-	17,0	15,0	11,2	-	16,0	14,9	11,1	136
138	-	16,8	14,8	-	-	16,9	14,9	-	-	16,0	14,8	11,1	138
141	-	16,6	14,6	-	-	16,7	14,8	-	-	15,8	14,7	11,0	141
142	-	16,6	14,6	-	-	16,7	14,7	-	-	15,8	14,7	-	142
146	-	16,3	14,5	-	-	16,5	14,6	-	-	15,8	14,5	-	146
147	-	16,2	14,4	-	-	16,5	14,6	-	-	15,8	14,5	-	147
150	-	16,1	-	-	-	16,3	14,4	-	-	15,8	14,5	-	150
151	-	16,0	-	-	-	16,2	14,4	-	-	15,8	14,4	-	151
152	-	-	-	-	-	16,2	14,4	-	-	15,8	14,4	-	152
154	-	-	-	-	-	16,1	-	-	-	15,8	14,4	-	154
156	-	-	-	-	-	16,0	-	-	-	15,8	14,4	-	156
157	-	-	-	-	-	-	-	-	-	15,8	14,3	-	157
158	-	-	-	-	-	-	-	-	-	15,8	-	-	158
161	-	-	-	-	-	-	-	-	-	15,8	-	-	161

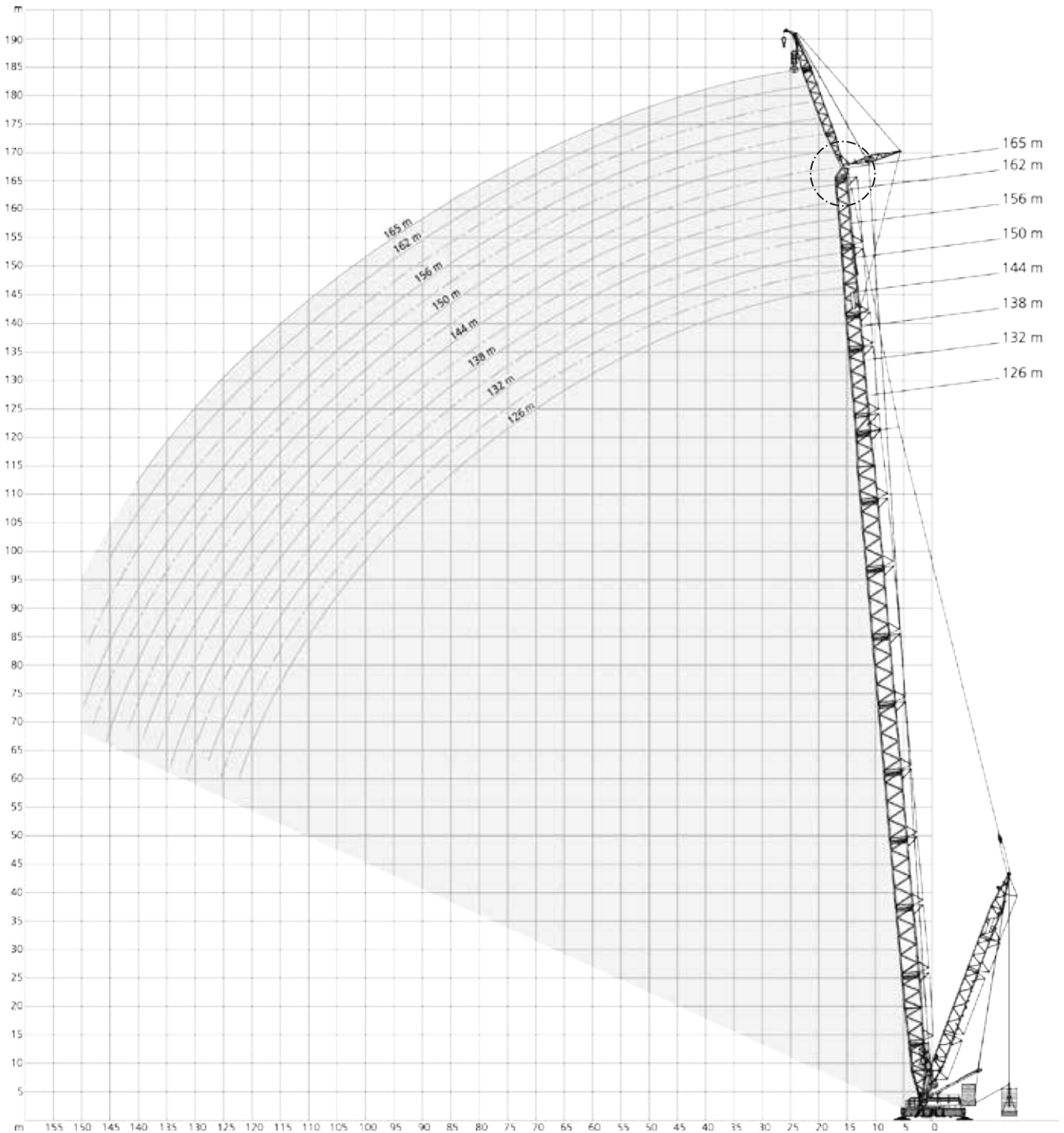
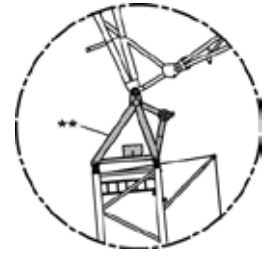
0t
65t
95t
125t
165t
205t
265t
325t



** Option · Option · En option · Opzione · Opcion · Opcional · Опция

Anmerkungen zu den Tragfähigkeiten · Conditions d'utilisation · Annotazioni sulle portate · Condiciones de utilización · Notas sobre capacidade de içamento · Примечания по грузоподъемности

Ratings are in compliance with EN 13000/ISO 4305 and ASME B 30.5.
Weight of hook blocks and slings is part of the load, and is to be deducted from the capacity ratings.

Consult operation manual for further details.

Note: Data published herein is intended as a guide only and shall not be construed to warrant applicability for lifting purposes.
Crane operation is subject to the computer charts and operation manual both supplied with the crane.

In some instances the superlift counterweight does not lift off the ground with the indicated load.

Tragfähigkeiten entsprechen EN 13000/ISO 4305 und ASME B 30.5.

Das Gewicht der Unterflaschen, sowie die Lastaufnahmemittel, sind Bestandteile der Last und sind von den Tragfähigkeitsangaben abzuziehen.

Weitere Angaben in der Bedienungsanleitung des Kranes.

Anmerkung: Die Daten dieser Broschüre dienen nur zur allgemeinen Information; für ihre Richtigkeit übernehmen wir keine Haftung.
Der Betrieb des Kranes ist nur mit den Original-Tragfähigkeitstabellen und mit der Bedienungsanleitung zulässig, die mit dem Kran mitgeliefert werden.

In einigen Fällen hebt das Superliftgegengewicht bei den angegebenen Traglasten nicht ab.

Le tableau de charges est conforme à la norme EN 13000/ISO 4305 et ASME B 30.5.

Les poids du crochet-moufle et de tous les accessoires d'élingage font partie de la charge et sont à déduire des charges indiquées.

Pour plus de détails consulter la notice d'utilisation de la grue.

Nota : Les renseignements ci-inclus sont donnés à titre indicatif et ne représentent aucune garantie d'utilisation pour les opérations de levage. La mise en service de la grue n'est autorisée qu'à condition que les tableaux de charges ainsi que le manuel de service, tels que fournis avec la grue, soient observés.

Le contrepoids du superlift ne décolle pas dans certaines configurations des tableaux de charge.

Le portate sono conformi alla norma EN 13000/ISO 4305 e ASME B 30.5.

Il peso del bozzello e delle funi d'attacco fanno parte del carico e sono quindi da detrarre dai valori di tabella.

Per ulteriori dettagli sulla velocità vento, consultare il manuale di istruzione della gru.

Nota: I dati riportati su tale prospetto sono solo a titolo indicativo e pertanto non impegnativi. L'impiego della gru è ammesso solo rispettando le tabelle originali ed il manuale di uso fornito assieme alla gru.

In alcuni casi, con il carico indicato, il contrappeso Superlift non si solleva dal suolo.

Las capacidades de carga están sujetas a las normas EN 13000/ISO 4305 y ASME B 30.5.

El peso de los ganchos y eslingas son parte de la carga y serán deducidos de las capacidades brutas.

Consultar los manuales de operación para ampliar información.

Observación: Los datos publicados son solamente orientativos y no se deben interpretar como garantía de aplicación para determinadas operaciones de elevación. La manipulación de la grúa está sujeta a las cargas programadas en el ordenador y en el manual de operaciones, ambos suministrados con la grúa.

En algunos casos, el contrapeso superlift no se eleva del suelo con la carga indicada.

Valores nominais de acordo com a EN 13000/ISO 4305 e ASME B 30.5.

O peso dos moitões e eslingas faz parte da carga e tem de ser subtraído das capacidades nominais.

Consultar manual de operação para outros detalhes.

Nota: Os dados publicados aqui destinam-se a simples orientação e não devem ser interpretados como garantia de aplicabilidade para fins de içamento. A operação da grua depende de tabelas de computador e do manual de operação, ambos fornecidos com a máquina.

Em alguns casos, o contrapeso do Superlift não levanta do solo com a carga indicada.

Номинальные значения соответствуют EN 13000/ISO 4305 и ASME B 30.5.

Вес крюкоблока и строп является частью груза и должен вычитаться из номинальных значений грузоподъемности.

Подробности см. в руководстве по эксплуатации.

Примечание. Публикуемые в настоящем издании данные приводятся только для справки и не должны использоваться при расчете нагрузки. При эксплуатации крана должны применяться компьютерные таблицы и руководство по эксплуатации, входящие в комплект поставки крана.

В некоторых случаях противовес системы суперлифт не может быть поднят с земли с указанной нагрузкой.

Notes

PC 3800-1

Notizen · Notes · Nota · Notas · Notas ·
пометы, комментарии, примечания

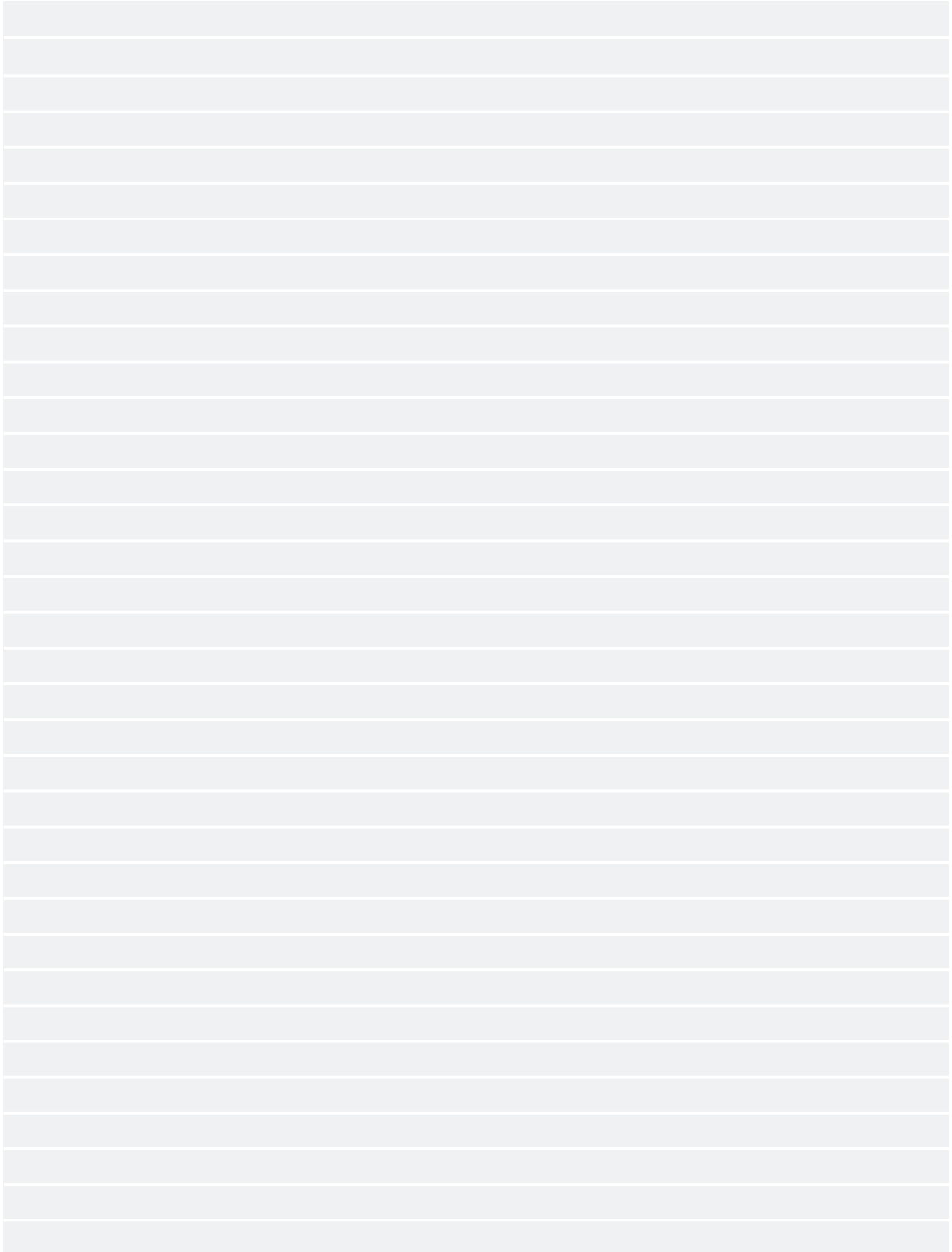

PC center pot

	Consisting of center pot and 4 outriggers.
Center pot	Bending- and torsion-resistant welded structure of pot type construction, fabricated of high-strength fine-grain structural steel.
Outriggers	Bending-resistant welded structure of high-strength fine grain structural steel. The outriggers are consisting of two parts each: connection part of fixed length and telescopic part to adjust outriggers to one of three support bases. The telescopic part can be folded for easy transport at job site.
Support bases	12 m x 12 m 14 m x 14 m 16 m x 16 m
Outrigger mats	The standard outrigger mat dimensions are 2.3 m x 2.3 m (5.3 m ²). There is sufficient clearance between these mats at a support base of 12 m x 12 m and the superlift tray at 11 m superlift radius. Bigger mats are available as an option. The superlift tray must be lifted above those mats in some cases.

Superstructure

Counterweight	225 t counterweight on superstructure. Steel box type. Options in block weights 7.5 t, 10 t.
Total weight	Approx. 340 t, incl. 225 t counterweight, 24 m SH_1 boom and hook block.
Reeving winch	Mounted on superstructure.
Frame	Torsion-resistant welded structure fabricated of high-strength fine grain structural steel.
Slew ring	Triple-row roller bearing slew ring with external ring gear for ease of service and maintenance. Central lubrication system.
Drive	Pump distribution gearbox with five variable displacement axial piston pumps, and gear pumps. Silencer with spark-arrestor. Sound insulation covering. 6 cylinder MTU diesel engine type 6R1300. Output: 390 kW (523 HP) at 1700 1/min, torque 2450 Nm (1807 lb-ft) at 1300 1/min each. The engine complies with EUROMOT 4, Tier 4 final and CARB regulations. The system is equipped with Ad-Blue and a SCR catalytic converter. Optional for non-regulated markets: 8 cylinder MTU diesel engine type OM 502 LA. Output: 405 kW (550 HP) at 1800 1/min, torque 2600 Nm at 1080 1/min each. The engine complies with EUROMOT 3a, EPA T3 and CARB regulations. Fuel tank capacity: 1217 l.
Rope drums	The standard superstructure equipment includes three rope drums – hoist 1, 2 and boom hoist. The drums are powered by hydraulic motors through closed planetary gear units running in oil bath. All rope drums have spring-applied, hydraulically released multi-disk brakes and non-wearing hydraulic braking for load lowering. Rope ends H 1, 2, 3 and W 1, 2 equipped with quick-connect rope end-fittings. All winches are removable to minimise weight for transportation.
A-frame	Hydraulic raising systems for A-frame as standard. A-frame, boom hoist and sheave sets for boom hoist can be dismantled as one single transport unit to minimise transport weight. Dismantling of hoist 1 and 2 possible without removing A-frame first.
Slew unit	Powered by hydraulic motors through 2 closed, planetary gear units running in oil bath. Spring-applied, hydraulically released holding brakes and non-wearing hydraulic braking. Slew speed infinitely variable 0-1 rpm.
Control system	Terex IC-1: Electronic proportional valve pilot control integrated in stored-program control system incl. diagnostic system. Two monitors with colour displays, load moment indicator operated via a touch screen. Working speeds infinitely variable controlled by the lever position. Automatic power control for optimal utilisation of engine output; emergency control systems. Additional functions: <ul style="list-style-type: none"> • Infinitely variable position of Superlift counterweight with the optional adjustable Superlift system 11-19 m • Infinitely variable position of main boom angle in SWSL configuration 55-87° (65-87° in SW configuration) • Working area limitation • Diagnosis and troubleshooting • User defined joystick mode The crane is controlled by joystick levers ergonomically positioned in the crane cab. Wireless rigging remote control. Wireless emergency remote control.
Cab	Comfortable cab with large windscreen and air condition. Shatterproof-glazing all around, roof window, self-contained hot air heater, full instrumentation and crane controls. Infinitely adjustable operator seat, emergency seat, multiple storage areas, 12-V power plug. The cab can be tilted back for improved operator view of boom point. A camera system is installed to monitor the rope drums. Front window can be opened. Dashboard can be adjusted for optimum ergonomics and view. Front wiper with resting position outside of window area for optimum view. For transportation, the cab swings hydraulically in front of the superstructure to minimise width.
Electrical equipment	24 V DC. system (2 x batteries 12 V, 200 Ah).
Operator aids	Load moment indicator integrated in IC-1 control (load moment, radius, angles, engine and hydraulic system monitoring), hoist limit switch, limit switches for boom movements, hydraulic boom backstop, position light, anemometer.

Boom Combinations

See page 16-21.

Optional equipment

Hydraulic quick connection

Outrigger pads 6.0 m x 2.4 m 14,4 m² instead of standard mats of 5,3 m². To reduce ground pressure.

Alternative counterweight slabs Made of cast iron (less in height than standard steel box slabs).

Counterweight arrangements Composition of 10 t + 7.5 t or 10 t + 15 t.

SL counterweight plates Up to 350 t consisting of standard plates 10 t or 10 t and 7.5 t mixed, steel box or cast iron.

Adapters for axle lines Adapters for road transport of center pot and superstructure with axle lines (Faymonville, Goldhofer, Scheuerle) or for job site transport with SPMT.

Hydraulic cylinder on A-frame For self-assembly of boom.

Hydraulic cylinder with or without hydraulic unit For boom pinning.

Boom Booster Kit Consists of 2 x 12 m adapter sections and up to 7 x 12 m inserts. Available in length 24 m, 48 m, 60 m, 84 m, 108 m. Extension of Superlift mast from 36 m to 39.5 m or 42 m.

Flex frame Infinite positioning of Superlift counterweight from 13-21 m.

Split tray Superlift tray frame with removable platform underneath the center stack of counterweights (center stack max. 125 t).

Standard SL 36 m Superlift mast incl. hoist W2. SL pendant bars, mast back stop cylinders, SL tray. Superlift counterweight 0 t at radius 9 m or 0-325 t on counterweight tray at fixed radii 11 m, 13 m, 15 m, 17 m and 19 m.

Variable SL Variable 36 m Superlift mast (see Standard SL). Additional vertical hydraulic cylinders and stabilisation winch on superstructure (prevents weaving of counterweight especially when traveling and slewing). Height compensation using the cylinders, lifting across obstacles possible to a certain extent. Superlift counterweight 0 t at radius 9 m or 0-325 t on counterweight tray, indefinitely variable from 11-19 m.

SL counterweight carrier Superlift mast (see Standard SL). Telescopic frame and counterweight carrier for total weight of 325 t, with 4 wheels / 2 axles (driven and steered – full manoeuvrability for slewing, trailing, and parallel modes). Superlift counterweight 40-325 t on counterweight carrier with fixed mast radius approx. 16 m; infinitely adjustable from 17-19 m with telescopic frame. The counterweight carrier allows for traveling or slewing even when the Superlift counterweight does not lift off the ground (e.g. crane with loads as indicated by load chart values in brackets).

Hoist H3 Additional hoist for main boom (to operate LF or runner), line pull same as H1, length 650 m.

Runner Max. lifting capacity 54 t. Mounted on boom head and boom / jib top. Operation by hoist rope 3 (see variable SL).

Runner for LF standard Max. lifting capacity 18 t. Operated by hoist 3.

Special LF linkage head Without sheave set for higher lifting capacities when using LF.

3 m intermediate section For 3 m-intermediate lengths.

PC-Mittelrahmen

	Bestehend aus Mittelrahmen und 4 Abstützungen.
Mittelrahmen	Verformungs- und verwindungssteife Schweißkonstruktion in Rahmenbauweise, gefertigt aus hochfestem Feinkornbaustahl.
Abstützungen	Verformungssteife Schweißkonstruktion aus hochfestem Feinkornbaustahl. Jede Abstützung besteht aus zwei Teilen: dem Anschlussstück in fester Länge und einem ausfahrbaren Teleskopteil zum Einstellen der Abstützungen auf eine von drei möglichen Abstützflächen. Zum einfachen Transport am Einsatzort kann der Teleskopteil eingeklappt werden.
Abstützflächen	12 m x 12 m 14 m x 14 m 16 m x 16 m
Abstützmatten	Die Standard-Abstützmatten messen 2,3 x 2,3 m (5,3 m ²). Bei einer Abstützfläche von 12 x 12 m und 11 m Superlift-Radius besteht somit ausreichender Abstand zwischen diesen Matten und der Superlift-Traverse. Größere Matten sind optional erhältlich. In einigen Fällen muss das Superlift über diese Matten gehoben werden.

Oberwagen

Gegengewicht	225 t Gegengewicht am Oberwagen. Stahlkastenausführung. Optionen in Blockgewichten 7,5 t, 10 t.
Gesamtgewicht	Ca. 340 t, einschl. 225 t Gegengewicht, 24 m SH_1 Hauptausleger und Unterflasche.
Einscherwinde	Auf Oberwagen angebaut.
Rahmen	Verformungssteife Schweißkonstruktion aus hochfestem Feinkornbaustahl.
Drehkranz	3-reihige Rollendrehverbindung mit Außenzahnkranz für einfache Wartung. Zentralschmierung.
Antrieb	Pumpenverteilergetriebe mit fünf verstellbaren Axialkolbenpumpen und zusätzlichen Zahnradschmieren. Schalldämpfer mit Funkenfänger. Schalldämm-Abdeckung. 6-Zylinder MTU Dieselmotor Typ 6R1300. Leistung: jeweils 390 kW (523 PS) bei 1700 1/min, Drehmoment 2450 Nm (1807 lb-ft) bei 1300 1/min. Der Motor entspricht den Abgasnormen EUROMOT 4, Tier 4 Final und CARB. Das System arbeitet mit Ad-Blue und einem SCR-Katalysator. Optional für nicht-regulierte Märkte: 8-Zylinder MTU Dieselmotor Typ OM 502 LA. Leistung: Jeweils 405 kW (550 PS) bei 1800 1/min, Drehmoment 2600 Nm bei 1080 1/min. Der Motor entspricht den Abgasnormen EUROMOT 3a, EPA T3 und CARB. Kraftstoffbehälter: 1217 l.
Seilwinden	Der Oberwagen ist serienmäßig mit drei Seilwinden – Hubwerk 1, Hubwerk 2 und Einziehwerk – ausgerüstet. Der Antrieb der Winden erfolgt durch Hydromotoren mit geschlossenen, ölbadgeschmierten Planetengetrieben. Alle Seilwinden sind mit federbelasteten, hydraulisch freigegebenen Lamellenbremsen und verschleißfreier, hydraulischer Bremsung für die Lastabsenkung ausgestattet. Die Seilenden der Winden H 1, 2, 3 und W 1, 2 sind mit Pressfitting und Taschen ausgestattet. Alle Winden sind zur Minimierung des Transportgewichtes demontierbar.
A-Bock	Hydraulische A-Bock-Umlage serienmäßig. A-Bock zur Minimierung des Transportgewichtes gemeinsam mit Einziehwerk und Rollensätzen als komplette Transporteinheit demontierbar. Hubwerk 1 und 2 können ohne vorherige Demontage des A-Bocks demontiert werden.
Drehwerk	Antrieb durch Hydromotoren über 2 geschlossene, ölbadgeschmierte Planetengetriebe. Federbelastete, hydraulisch freigegebene Haltebremse und verschleißfreie hydraulische Bremsung. Drehgeschwindigkeit stufenlos einstellbar von 0-1 1/min.
Steuerung	Terex IC-1: Elektronische Proportionalventilvorsteuerung integriert in speicherprogrammierte Steuerung mit Fehlerdiagnose. Zwei Farbbildschirme, Lastanzeige, Bedienung über Touchscreen. Stufenlos über Hebelposition regelbare Arbeitsgeschwindigkeiten. Antriebs-Leistungsregelung für optimale Nutzung der Motorleistung; Notsteuerung. Zusatzfunktionen: <ul style="list-style-type: none"> • Stufenlos einstellbare Position des Superlift-Gegengewichts mit dem Superlift-Verstellungssystem 11-19 m (optional) • Hauptauslegerwinkel in SWSL-Konfiguration stufenlos von 55-87° verstellbar (SW: 65-87°) • Arbeitsbereichsbegrenzung • Diagnose und Fehlersuche • Nutzerdefinierter Joystickmodus Kransteuerung durch ergonomisch angeordnete Joysticks. Funkfernsteuerung zum Rüsten. Not-Funkfernsteuerung.
Kabine	Komfortkabine mit großzügig dimensionierter Frontscheibe und Klimaanlage. Sicherheitsverglasung rundum, Dachfenster, motorunabhängige Warmluftheizung, Steuer- und Kontrollelemente für die Kranfunktionen. Stufenlos einstellbarer Fahrersitz, Notsitz, vielfältige Ablagemöglichkeiten, 12 V-Steckdose. Die Kabine ist zur Sichtverbesserung nach hinten neigbar. Zur Überwachung der Winden ist ein Kamerasystem installiert. Frontfenster kann geöffnet werden. Armaturenbrett für beste Sicht und Ergonomie einstellbar. Front-Wischerruhestellung außerhalb des Fensters für optimale Sicht. Während des Transportes ist die Kabine zur Minimierung der Gesamtbreite vor den Oberwagen hydraulisch geschwenkt.
Elektrische Anlage	Betriebsspannung 24 V (2 Batterien 12 V / 200 Ah).
Sicherheitseinrichtungen	Lastmomentbegrenzer in IC-1 integriert (Lastmoment, Ausladung, Winkel, Motor- und Hydrauliküberwachung) Hubendschalter, Endschalter für Auslegerbewegungen, hydraulische Ausleger-Rückfallsicherungen, Positionsleuchte, Windmesser.

Ausleger-Kombinationen

Siehe Seite 16-21.

Zusatzausrüstung

Hydraulische Schnell- verbindung

Stützteller 6,0 x 2,4 m

14,4 m² anstelle von 5,3 m²-Standardmatten. Zur Bodendruckreduzierung.

Alternative Gegengewichts- platten

Aus Stahlguss (flacher als Standard-Stahlkastenträger).

Gegengewicht-Kombi- nationen

10 + 7,5 t oder 10 + 15 t.

SL-Gegengewichtsplatten

Bis zu 350 t bestehend aus 10 t-Standardplatten oder 10 t und 7,5 t gemischt, Stahlkasten oder Stahlguss.

Adapter für Achslinien

Adapter zum Straßentransport des Mittelrahmens und Oberwagens per Achslinien (Faymonville, Goldhofer, Scheuerle) oder für den Transport vor Ort mittels SPMT.

Hydraulikzylinder am A-Bock

Zur Selbstmontage des Auslegers.

Hydraulikzylinder ohne oder mit Hydraulikaggregat

Für Auslegerverbolzung.

Boom Booster Kit

Besteht aus 2 x 12 m Adaptersegmenten und bis zu 7 x 12 m Einsätzen.
Verfügbare Längen: 24 m, 48 m, 60 m, 84 m, 108 m.
Verlängerung des Superlift-Masts von 36 m auf 39,5 m oder 42 m.

Flex frame

Stufenlose Positionierung des Superlift-Gegengewichts von 13 m bis 21 m.

Split tray

Superlift-Traversenrahmen mit demontierbarer Plattform unterhalb des mittigen Gegengewichtstapels (mittiger Stapel max. 125 t).

Standard SL

36 m Superlift-Mast inkl. Winde W2.
SL Abspannstangen, Mast-Rückfallzylinder, SL-Traverse.
Superlift-Gegengewicht 0 t auf Radius 9 m oder 0-325 t auf Gegengewichts-Traverse mit fest eingestellten 11 m, 13 m, 15 m, 17 m, 19 m.

Variabler SL

36 m Superlift-Mast (siehe Standard SL).
Zusätzliche, vertikale Hydraulikzylinder und Stabilisierungswinde auf dem Oberwagen (verhindert Pendeln des Gegengewichts, insbesondere beim Verfahren und Schwenken). Höhenausgleich mittels Zylinder, Hub über Störkanten / Hindernisse hinweg in bestimmten Grenzen möglich. Superlift-Gegengewicht 0 t auf Radius 9 m oder 0-325 t auf Gegengewicht-Traverse einstellbar stufenlos von 11-19 m.

SL-Gegengewichtswagen

Superlift-Mast (siehe Standard SL). Teleskoprahmen und Gegengewichtswagen für 325 t Gesamtgewicht, 4 Räder / 2 Achsen (angetrieben und gelenkt – voll manövrierbar in Fahrzuständen Drehen, Hinterherfahrt und Nachlauf). Superlift-Gegengewicht 40-325 t auf Gegengewichtswagen mit festem Mastradius ca. 16 m; stufenlos einstellbar von 13-17 m bzw. 17-19 m mit Teleskoprahmen. Der Gegengewichtswagen erlaubt Fahren und Drehen, auch wenn das Superliftgegengewicht nicht vom Boden abhebt (Beispiel: Kran mit Last am Haken bei Tabellenwerten in Klammern).

Seilwinde H3

Zusätzliche Seilwinde im Hauptausleger (zum Betrieb an LF oder Runner), Seilzug wie H1, Länge 650 m.

Runner

Max. Traglast 54 t. Montage auf Auslegerkopf und Ausleger-/Hilfsauslegerspitze. Betrieb durch Hubseil 3 (siehe Variabler SL).

Runner für LF serienmäßig

Max. Traglast 18 t. Antrieb durch Hubwerk 3.

Spezieller LF-Anlenkkopf

Ohne Rollensatz für höhere Tragfähigkeiten am LF.

3 m-Zwischenstück

Für 3 m-Zwischenlängen.

Structure centrale PC

	Comprend la structure centrale et 4 stabilisateurs.
Structure centrale	Structure soudée résistante à la flexion et à la torsion ; construction structurelle ; acier de construction à haute résistance et grains fins.
Stabilisateurs	Structure soudée résistante à la flexion ; acier de construction à haute résistance et grains fins. Stabilisateurs en deux parties : section de connexion de longueur fixe et section télescopique permettant de régler les stabilisateurs sur l'un des trois bases de calage. Section télescopique repliable pour un transport simplifié jusqu'au chantier.
Bases de calage	12 m x 12 m 14 m x 14 m 16 m x 16 m
Semelles de calage	Semelles de calage standard mesurant 2,3 m x 2,3 m (5,3 m ²). Garde suffisante entre les semelles avec base de calage de 12 m x 12 m et le plateau SuperLift avec rayon de 11 m. Semelles de taille supérieures disponibles en option. Possibilité de lever le plateau SuperLift au-dessus des semelles pour certaines configurations.

Partie supérieure

Contrepoids	Contrepoids de 225 t sur la partie supérieure. Cellules acier. Blocs de contrepoids de 7,5 t et 10 t en option.
Poids total	Env. 340 t, avec 225 t de contrepoids, flèche de 24 m SH_1 et crochet.
Tambour de mouflage	Monté sur la partie tournante.
Charpente	Structure mécano-soudée résistante à la torsion, en acier grain fin haute résistance.
Couronne d'orientation	Couronne d'orientation à trois rangées de rouleaux avec couronne dentée externe pour une maintenance simplifiée. Graissage automatique centralisé.
Entraînement	Boîte de transfert à cinq pompes à pistons axiaux à débit variable et pompes à engrenage auxiliaires. Silencieux avec pare-étincelle. Capot d'isolation sonore. Moteur diesel MTU, type 6R1300, 6 cylindres. Puissance : 390 kW (523 HP) à 1700 tr/mn, couple de 2450 Nm (1807 lb-ft) à 1300 tr/mn chacun. Le moteur satisfait aux normes EUROMOT 4, Tier 4 final et CARB. Le système est équipé d'un convertisseur catalytique Ad-Blue et RCS. En option pour les marchés non-régulés : Moteur diesel MTU, type OM 502 LA, 8 cylindres. Puissance : 405 kW (550 HP) à 1800 tr/mn, couple de 2600 Nm à 1080 tr/mn chacun. Le moteur satisfait aux normes EUROMOT 3a, EPA T3 et CARB. Réservoir de carburant : 1217 l.
Treuil	L'équipement standard de la partie tournante inclut trois tambours – treuil no 1, treuil no 2 et mécanisme de relevage. Les tambours sont entraînés par des moteurs hydrauliques munis de réducteurs planétaires, sous bain d'huile, en carter étanche. Tous les tambours sont dotés de freins multidisques à commande par ressort et desserrage hydraulique et disposent d'une fonction de freinage hydraulique inusable pour l'abaissement de la charge. Les pattes de câble H 1, 2, 3 et W 1, 2 sont équipées des attaches à jonction rapide. Tous les treuils sont démontables pour diminuer le poids de transport.
Chevalet	Systèmes de relevage hydraulique de série. Le chevalet, le treuil de relevage et les jeux de poulies pour le treuil de relevage peuvent être démontés en un seul bloc pour minimiser le poids au transport. Démontage des treuils 1 et 2 possible sans dépose préalable du chevalet.
Mécanisme d'orientation	Entraînée par des moteurs hydrauliques munis de 2 réducteurs planétaires, sous bain d'huile, en carter étanche. Freins d'arrêt à commande par ressort, à desserrage hydraulique et freinage hydraulique inusable. Vitesse d'orientation variable en continu entre 0 et 1 tr/min.
Commande	Terex IC-1 : Commande à électrovanne proportionnelle intégrée dans le système de commande par programme enregistré avec système de diagnostic. 2 écrans couleurs, contrôleur d'état de charge actionné par écran tactile. Les vitesses de travail sont réglées sans paliers par la position du levier. Commande automatique pour une exploitation optimale de la puissance moteur ; systèmes de commande d'urgence. Fonctions additionnelles : <ul style="list-style-type: none"> • Position variable en continu du contrepoids superlift avec système superlift réglable en option entre 11-19 m • Angle variable en continu de la flèche principale en configuration SWSL 55-87° (65-87° en configuration SW) • Limitation de la zone de travail • Diagnostic et dépannage • Mode manipulateur réglable en fonction de l'utilisateur Position ergonomique des manipulateurs de commande dans la cabine du grutier. Commande à distance pour le montage. Commande d'urgence à distance sans fil.
Cabine	Cabine confortable avec large pare-brise et climatisation. Vitrage de sécurité panoramique, lucarne, chauffage à air autonome, tableau de bord avec l'ensemble des organes de commande et instruments de contrôle. Siège opérateur à réglage continu, siège de secours, nombreux rangements, prise 12 V. La cabine peut être inclinée vers l'arrière, pour une meilleure visibilité sur la flèche. Un système de caméras vidéo permet de surveiller les tambours. Ouverture possible du pare-brise avant. Tableau de bord réglable pour une ergonomie et une visibilité optimales. Essuie-glace avant avec position d'arrêt hors de la vitre pour une meilleure visibilité. La cabine pivote hydrauliquement pour se ranger devant la partie tournante et minimiser la largeur lors des transports.
Installation électrique	Système 24 V DC (2 batteries 12 V / 200 Ah).
Dispositif de sécurité	Contrôleur d'état de charge intégré dans la commande IC-1 (état de charge, rayon, angles, surveillance moteur et hydraulique), interrupteur de fin de course des treuils et pour les mouvements de la flèche, vérin anti-retour de flèche hydraulique, feu de position, anémomètre.

Combinaisons de flèche

Voir page 16-21.

Equipements optionnels

Connexion rapide hydraulique

Semelles de calage de 6,0 m x 2,4 m 14,4 m² ; remplace les semelles standard de 5,3 m². Permet de réduire la pression au sol.

Plaques de contrepoids en option Plaques en fonte (hauteur inférieure à celle des cellules acier standard).

Combinaison de contrepoids Combinaison de plaques 10 t + 7,5 t ou 10 t + 15 t.

Plaques de contrepoids SL Jusqu'à 350 t avec des plaques standard de 10 t ou de 7,5 t ; cellules acier ou fonte.

Adaptateurs pour axes d'essieu Adaptateurs pour le transport sur route de la structure centrale et de la partie supérieure avec axes d'essieu (Faymonville, Goldhofer, Scheuerle) ou les déplacements en chantier avec SPMT.

Vérin hydraulique sur chevalet Pour le montage autonome de la flèche.

Vérin hydraulique avec ou sans groupe hydraulique Pour boulonnage de la flèche.

Kit Boom Booster Intègre deux sections d'adaptateur de 12 m et jusqu'à 7 intercalaires de 12 m. Longueurs disponibles : 24 m, 48 m, 60 m, 84 m, 108 m. Extension du mât Superlift de 36 m à 39,5 m ou 42 m.

Option Flex Frame Positionnement illimité du contrepoids de la Superlift entre 13 et 21 m.

Plateau Split Tray Plateau avec plateforme amovible située sous la pile de contrepoids centrale de la Superlift (poids maximal des contrepoids : 125 t).

Standard SL Mât 36 m superlift incl. treuil W2. Tirants SL, vérin anti-retour du mât, panier SL. Contrepoids superlift 0 t à 9 m de rayon ou 0-325 t sur panier de contrepoids avec rayons fixes de 11 m, 13 m, 15 m, 17 m et 19 m.

SL variable Mât superlift 36 m variable (voir SL standard). Vérins hydrauliques verticaux additionnels et treuil de stabilisation sur la partie tournante (prévient le balancement du contrepoids, surtout pendant les déplacements et l'orientation). Compensation de la hauteur via les vérins, levage par-dessus les obstacles possibles jusqu'à un certain point. Contrepoids superlift 0 t à 9 m de rayon ou 0-325 t sur panier de contrepoids avec rayons variable en continu entre 11 m et 19 m.

Chariot de contrepoids SL Mât superlift (voir standard SL). Structure télescopique et chariot de contrepoids pour un poids total de 325 t avec 4 roues / 2 essieux (moteurs et directeurs – grande manœuvrabilité en déplacement circulaire, traction et modes parallèle). Contrepoids superlift 40-325 t sur chariot avec rayon de mât fixe de 16 m environ ; réglable en continu à 13-17 m ou 17-19 m resp. avec structure télescopique. Le chariot de contrepoids permet le déplacement ou l'orientation même avec le contrepoids superlift maintenu au sol (par ex. grue avec charges au crochet pour les valeurs entre parenthèses dans le tableau de charges).

Treuil H3 Treuil additionnel pour flèche principale (pour configuration LF ou potence), traction du câble équivalente à H1, longueur 650 m.

Potence Capacité max. 54 t. Montée en tête de flèche et en pointe de flèche / fléchette. Utilisation avec câble de treuil 3 (voir SL variable).

Potence pour LF standard Capacité de levage max. 18 t. À utiliser avec le treuil 3.

Tête de tringlerie LF spéciale Sans jeu de poulies pour des capacités de levage supérieures en configuration LF.

Segment intermédiaire de 3 m Pour longueurs intermédiaires de 3 m.

Sezione centrale gru su piedistallo

Comprendente una sezione centrale e 4 stabilizzatori.

Sezione centrale	Struttura saldata e scatolare, resistente a torsioni e flessioni, realizzata in acciaio strutturale ad alta resistenza a grana fine.
Stabilizzatori	Struttura saldata resistente a flessioni, realizzata con acciaio strutturale pregiato a grana fine. Gli stabilizzatori sono costituiti da due parti ciascuno: una sezione di raccordo di lunghezza fissa e una sezione telescopica per regolare gli stabilizzatori su una delle tre basi. La sezione telescopica può essere ripiegata per facilitare il trasporto in cantiere.
Basi di supporto	12 m x 12 m 14 m x 14 m 16 m x 16 m
Piastre di appoggio per stabilizzatori	Le dimensioni standard delle piastre di appoggio sono 2,3 m x 2,3 m (5,3 m ²). Ciò lascia uno spazio sufficiente tra le piastre nella base di supporto di 12 m x 12 m e il supporto Superlift con sbarraccio del Superlift di 11 m. In opzione sono disponibili piastre di appoggio più grandi. In alcuni casi, il supporto Superlift deve essere sollevato sopra tali piastre.

Torretta

Contrappeso	Contrappeso da 225 t nella torretta. Acciaio saldato. Opzioni in blocchi dal peso di 7,5 t, 10 t.
Peso totale	Circa. 340 t, incl. contrappeso 225 t, braccio 24 m SH_1 e bozzello.
Verricello di avvolgimento	Montato su torretta.
Struttura	Struttura saldata resistente a torsioni, realizzata in acciaio strutturale ad alta resistenza a grana fine.
Ralla	Ralla con cuscinetto a tre file di rulli, con corona esterna per facilità di manutenzione. Impianto di lubrificazione centralizzata.
Azionamento	Riduttore di distribuzione per cinque pompe a pistoni assiali a cilindrata variabile e pompe a ingranaggi. Marmitta con parascintille. Rivestimento insonorizzante. Motore diesel MTU tipo 6R1300, a 6 cilindri. Potenza erogata: 390 kW (523 HP) a 1700 giri/min, coppia di 2450 Nm (1807 lb-ft) a 1300 giri/min ciascuno. Il motore è conforme alle norme EUROMOT 4, Tier 4 Final (fase finale) e alla normativa CARB. Il sistema è dotato di Ad-Blue e convertitore catalitico SCR. Opzionale per mercati non regolamentati: Motore diesel MTU tipo OM 502 LA, a 8 cilindri. Potenza erogata: 405 kW (550 HP) a 1800 giri/min, coppia di 2600 Nm a 1080 giri/min ciascuno. Il motore è conforme alle norme EUROMOT 3a, EPA T3 e alla normativa CARB. Capacità del serbatoio: 1217 l.
Tamburi avvolgimento fune	La dotazione standard della torretta comprende tre tamburi: argano 1, argano 2 e argano del braccio. I tamburi sono azionati da motori idraulici tramite riduttori planetari in bagno d'olio, dotati di carter a tenuta. Tutti i tamburi sono equipaggiati di freni multidisco a molla, ad apertura idraulica e sistema di frenatura idraulica antiusura per la discesa del carico. Le cime delle funi H 1, 2, 3 e W 1, 2 sono dotate di dispositivo a sgancio rapido. Tutti gli argani sono rimovibili, per minimizzare il peso durante il trasporto.
Cuspide	Sistemi di sollevamento idraulico per la cuspide di serie. La cuspide, l'argano del braccio e la serie di pulegge possono essere smontate e trasportate come una singola unità, per minimizzare il peso durante il trasporto. Possibilità di smontaggio degli argani 1 e 2 senza richiedere la rimozione della cuspide.
Ralla	Azionata da motori idraulici tramite 2 riduttori planetari in bagno d'olio, dotati di carter a tenuta. Freni di arresto a molla, frenatura idraulica antiusura, con apertura idraulica. Velocità ralla a regolazione continua 0-1 giri/min.
Sistema di comando	Terex IC-1: Valvola di regolazione proporzionale elettronica integrata nel sistema di controllo software, comprendente sistema di diagnostica. 2 monitor a colori, limitatore di carico con touch-screen. Velocità di lavoro a regolazione continua sulla base della posizione della leva. Controllo automatico dell'alimentazione, per un utilizzo ottimale della potenza erogata dal motore; sistemi di controllo di emergenza. Funzioni aggiuntive: <ul style="list-style-type: none"> • Posizionamento a regolazione continua del contrappeso Superlift con sistema Superlift opzionale regolabile 11-19 m • Posizionamento a regolazione continua dell'inclinazione del braccio base in configurazione SWSL 55-87° (65-87° in configurazione SW) • Limitazione dell'area di lavoro • Diagnostica e individuazione dei guasti • Modalità joystick definita dall'utente <p>La gru è controllata mediante leve a joystick ubicate in posizione ergonomica nella cabina della gru. Comando wireless per attrezzamento. Comando wireless per emergenza.</p>
Cabina	Comoda cabina con ampio parabrezza e climatizzazione. Vettratura di sicurezza panoramica, tettuccio apribile, riscaldatore ad aria calda indipendente, strumentazione e comandi gru completi. Sedile regolabile a piacere dall'operatore, sedile di emergenza, numerosi vani portaoggetti, presa di alimentazione 12 V. La cabina può essere inclinata per incrementare la visibilità dell'operatore sul punto di lavoro del braccio. I tamburi avvolgimento fune sono dotati di videocamera di monitoraggio. Possibilità di aprire la finestra frontale. Il cruscotto può essere regolato per massimizzare l'ergonomia e la visibilità. Tergicristallo anteriore con posizione di riposo esterna all'area del parabrezza, per massimizzare la visibilità. Per il trasporto, la cabina ruota a comando idraulico sul lato anteriore della torretta, in modo da ridurre la larghezza.
Componenti elettrici	Impianto 24 VCC (2 batterie 12 V / 200 Ah).
Dispositivi di sicurezza	Limitatore di carico integrato nel dispositivo IC-1 (supervisione momento di carico, raggio, inclinazioni, motore e monitoraggio impianto idraulico), finecorsa argano, finecorsa per movimenti braccio base, antri retro idraulico braccio, luci di posizione, anemometro.

Combinazioni braccio

Vedere a pagina 16-21.

Equipaggiamento opzionale

Attacchi rapidi idraulici

Piatti di supporto per stabilizzatori 6,0 m x 2,4 m 14,4 m² in sostituzione delle piastre standard di 5,3 m². Per ridurre la pressione trasferita al suolo.

Lastre di contrappeso alternative Realizzate in ghisa (altezza inferiore rispetto alle lastre standard in acciaio saldato).

Configurazioni dei contrappesi Composizione di 10 t + 7,5 t oppure 10 t + 15 t.

Piastre di contrappeso SL Fino a 350 t costituite da piastre standard da 10 t oppure 10 t e 7,5 t miste, in acciaio saldato o ghisa.

Adattatore per linee degli assi Adattatori per il trasporto su strada della sezione centrale e della torretta con le linee degli assi (Faymonville, Goldhofer, Scheuerle) o per il trasporto in cantiere con rimorchi modulari semoventi.

Cilindro idraulico su cuspidi Per l'autoassemblaggio del braccio.

Cilindro idraulico con o senza centralina idraulica Per il fissaggio a mezzo spine del braccio.

Kit Boom Booster Costituito da 2 sezioni di adattamento da 12 m e fino a 7 inserti da 12 m. Lunghezze disponibili 24 m, 48 m, 60 m, 84 m, 108 m. Estensione del montante Superlift da 36 m a 39,5 m o 42 m.

Flex frame Posizionamento infinito del contrappeso Superlift da 13-21 m.

Split tray Struttura del supporto Superlift con piattaforma rimovibile sotto lo stack centrale dei contrappesi (stack centrale max. 125 t)

Standard SL Montante Superlift 36 m compreso argano W2. SL: barre sospese, cilindri antiretro montante, telaio SL. Contrappeso Superlift 0 t con uno sbraccio di 9 m o 0-325 t sul telaio contrappesi con uno sbraccio fisso di 11 m, 13 m, 15 m, 17 m e 19 m.

SL variabile Montante Superlift 36 m variabile (vedere SL standard). Cilindri idraulici verticali aggiuntivi e argano di stabilizzazione sulla torretta (impediscono l'oscillazione del contrappeso, in particolare durante gli spostamenti su strada e le manovre di rotazione). Compensazione altezza mediante cilindri, sollevamento con superamento di ostacoli possibile in una certa misura. Contrappeso Superlift 0 t con uno sbraccio di 9 m o 0-325 t sul telaio contrappesi, con sbraccio variabile da 11 m a 19 m.

Supporto contrappesi SL Montante Superlift (vedere SL standard). Telaio telescopico e supporto contrappesi per un peso totale di 325 t, con 4 ruote / 2 assali (traente e sterzante – completa manovrabilità per rotazione, traino e modalità di spostamento parallele). Contrappeso Superlift 40-325 t su supporto contrappesi con sbraccio montante fisso di circa 16 m; regolazione continua da 13 a 17 m o da 17 a 19 m o con telaio telescopico. Il supporto contrappesi consente il trasporto su strada o la rotazione, anche con contrappeso Superlift non sollevato da terra (si applicano i carichi indicati tra parentesi nel diagramma di carico della gru).

Argano H3 Argano aggiuntivo per braccio base (per l'uso di LF o del runner), tiro come H1, lunghezza 650 m.

Runner Capacità max 54 t. Montato su testa braccio ed estremità falcone / braccio. Funzionamento mediante fune argano 3 (vedere SL variabile).

Runner per LF standard Capacità max. di sollevamento 18 t. Azionato con l'argano 3.

Testa tirante LF speciale Senza kit pulegge per una maggiore capacità di sollevamento quando si utilizza LF.

Sezione intermedia di 3 m Per lunghezze intermedie di 3 m.

Parte central PC

	Compuesto por parte central y 4 estabilizadores.
Parte central	Estructura soldada resistente a la flexión y a la torsión de construcción tipo cuba, fabricada de acero estructural de grano fino y alta resistencia.
Estabilizadores	Estructura soldada resistente a la flexión, fabricada de acero estructural de grano fino y alta resistencia. Los estabilizadores se componen de dos partes cada uno: parte de conexión de longitud fija y parte telescópica para ajustar los estabilizadores a una de las tres bases de soporte. La parte telescópica se puede plegar para facilitar el transporte en el lugar de trabajo.
Bases de soporte	12 m x 12 m 14 m x 14 m 16 m x 16 m
Bases de estabilizadores	Las dimensiones estándar de la base de los estabilizadores son 2,3 m x 2,3 m (5,3 m ²). Hay suficiente espacio libre entre estas bases para una base de soporte de 12 m x 12 m y la bandeja Superlift a un radio Superlift de 11 m. Opcionalmente también hay disponibles bases de mayor tamaño. En algunos casos la bandeja Superlift se debe levantar por encima de estas bases.

Superestructura

Contrapesos	225 t de contrapeso en la superestructura. Tipo cajón de acero. Las opciones en bloque pesan 7,5 t, 10 t.
Peso total	Aprox. 340 t, incl. contrapeso de 225 t, pluma de 24 m SH_1 y bloque de gancho.
Cabebrante pasador	Montado en la superestructura.
Bastidor	Estructura soldada resistente a la torsión, fabricada de acero de estructural de grano fino y alta resistencia.
Anillo de giro	Anillo de giro con rodamientos de tres hileras de rodillos, con corona dentada externa para una fácil reparación y mantenimiento. Sistema central de lubricación.
Tracción	Caja de engranajes de distribución de bombas con cinco bombas de pistón axial de desplazamiento variable y bombas de engranajes. Silenciador con parachispas. Cubierta con aislamiento acústico. Motor diésel MTU de 6 cilindros, tipo 6R1300. Potencia: cada uno 390 kW (523 HP) a 1700 rpm, par motor 2450 Nm (1807 lb-ft) a 1300 rpm. El motor cumple con los reglamentos EUROMOT 4, Tier 4 final y CARB. El sistema está equipado con Ad-Blue y un convertidor catalítico SCR. Opcional para mercados no regulados: Motor diésel MTU de 8 cilindros, tipo OM 502 LA. Potencia: cada uno 405 kW (550 HP) a 1800 rpm, par motor 2600 Nm a 1080 rpm. El motor cumple con los reglamentos EUROMOT 3a, EPA T3 y CARB. Capacidad del depósito de combustible: 1217 l.
Tambores de cable	El equipamiento de serie de la superestructura incluye tres tambores de cable: cabebrante 1, cabebrante 2 y cabebrante de pluma. Los tambores son accionados por motores hidráulicos a través de engranajes planetarios en cárter cerrado y baño de aceite. Todos los tambores de cable tienen frenos multidisco accionados por muelle y soltados hidráulicamente, y frenado sin desgaste para reducir el peso. Los extremos de los cables H 1, 2, 3 y W 1, 2 están equipados con accesorios de conexión rápida. Todos los cabebrantes pueden ser desmontados para minimizar el peso de transporte.
Caballette	Sistema hidráulico de elevación para caballette de serie. El caballette, el cabebrante de pluma y los juegos de poleas para cabebrante de pluma pueden desmontarse como una sola unidad de transporte para minimizar el peso de transporte. Es posible desmontar los cabebrantes 1 y 2 sin retirar primero el caballette.
Mecanismo de giro	Accionado por dos motores hidráulicos a través de engranajes planetarios en cárter cerrado y baño de aceite. Frenos accionados por muelle y soltados hidráulicamente, así como frenado hidráulico sin desgaste. Velocidad de giro en progresión continua de 0-1 rpm.
Sistema de control	Terex IC-1: Control piloto electrónico de válvulas proporcionales integrado en un sistema de control por programa almacenado, incl. sistema de diagnóstico. 2 monitores con pantallas a color, indicador de momento de carga operado mediante una pantalla táctil. Velocidades de trabajo controladas en progresión continua por la posición de la palanca. Control automático de potencia para un aprovechamiento óptimo de la potencia del motor; sistemas de control de emergencia. Funciones adicionales: <ul style="list-style-type: none"> • Posición del contrapeso Superlift variable en progresión continua con el sistema opcional Superlift ajustable de 11 a 19 m • Posición del ángulo de la pluma principal variable en progresión continua en configuración SWSL 55-87° (65-87° en configuración SW) • Limitación del área de trabajo • Diagnóstico y resolución de problemas • Modo de joystick definido por el usuario La grúa se controla mediante palancas de joystick ergonómicamente colocadas en la cabina. Control remoto inalámbrico para montaje. Control remoto inalámbrico de emergencia.
Cabina	Confortable cabina con amplio parabrisas y aire acondicionado. Lunas de seguridad, luna en el techo, calefacción de aire caliente autónoma, instrumentos y controles completos de la grúa. Asiento del operador totalmente ajustable, asiento de emergencia, múltiples áreas de almacenamiento, toma eléctrica de 12 V. La cabina puede ser inclinada hacia atrás para mejorar la visibilidad de manejo de la pluma. Ha sido instalado un sistema de cámara para supervisar los tambores de cable. Es posible abrir la luna delantera. El cuadro de mandos puede ajustarse para una ergonomía y una visibilidad óptimas. Limpiaparabrisas delantero con posición de reposo fuera del área de la luna para una óptima visibilidad. Para su transporte, la cabina gira hidráulicamente delante de la superestructura para reducir la anchura al mínimo.
Equipamiento eléctrico	Sistema de 24 V (2 baterías de 12 V / 200 Ah).
Dispositivos de seguridad	Indicador de momento de carga integrado en el control IC-1 (momento de carga, radio, ángulos, monitorización del motor y el sistema hidráulico), interruptor limitador de elevación, interruptores limitadores para los movimientos de la pluma, estabilizadores hidráulicos dorsales de la pluma, luz de posición, anemómetro.

Combinaciones de pluma

Véase página 16-21.

Equipamiento opcional

Conexión hidráulica rápida

Apoyos estabilizadores 6,0 m x 2,4 m 14,4 m² en vez de bases estándar de 5,3 m². Para reducir la presión sobre el terreno.

Placas de contrapeso alternativas Fabricadas en hierro fundido (menor altura que las placas tipo cajón de acero).

Configuraciones de contrapeso Composición de 10 t + 7,5 t o 10 t + 15 t.

Placas de contrapeso SL Hasta 350 t compuesto por placas estándar de 10 t o 10 t y 7,5 t combinadas, caja de acero o hierro fundido.

Adaptadores para líneas de ejes Adaptadores para el transporte por carretera de la pieza central y superestructura con líneas de ejes (Faymonville, Goldhofer, Scheuerle) o para el transporte en el lugar de trabajo con SPMT.

Cilindro hidráulico en el caballete Para el automontaje de la pluma.

Cilindro hidráulico con o sin unidad hidráulica Para fijación de pernos de pluma.

Kit Boom Booster Se compone de 2 secciones de adaptación de 12 m y hasta 7 insertos de 12 m. Longitudes disponibles 24 m, 48 m, 60 m, 84 m, 108 m. Extensión de mástil Superlift de 36 m a 39,5 m o 42 m.

Flex frame Posicionamiento infinito del contrapeso Superlift de 13 a 21 m.

Bandeja Split Tray Bastidor de bandeja Superlift con plataforma extraíble debajo de la pila central de contrapesos (pila central máx. 125 t).

SL estándar 36 m mástil Superlift incl. cabestrante W2. Barras colgantes SL, cilindros de apoyo de mástil, bandeja SL. Contrapeso Superlift de 0 t a un radio de 9 m o 0-325 t en bandeja de contrapesos a radios fijos de 11 m, 13 m, 15 m, 17 m y 19 m.

SL variable Mástil Superlift variable de 36 m (véase SL estándar). Cilindros hidráulicos verticales adicionales y cabestrante de estabilización en la superestructura (evita que los contrapesos oscilen, especialmente en desplazamientos y giros). Compensación de altura usando los cilindros, elevación a través de obstáculos posible hasta cierta medida. Contrapeso Superlift de 0 t a un radio de 9 m o 0-325 t en bandeja de contrapesos, progresión continua de 11 m a 19 m.

Carro de contrapesos SL Mástil Superlift (véase SL estándar). Bastidor telescópico y carro de contrapesos para un peso total de 325 t, con cuatro ruedas / 2 ejes (con tracción y dirección: maniobrabilidad completa para modos paralelo, de giro y de remolque). Contrapeso Superlift de 40-325 t en carro de contrapesos con radio de mástil fijo de aprox. 16 m; ajustable en progresión continua de 13-17 m o 17-19 m, o con bastidor telescópico. El carro de contrapeso permite la marcha y el giro incluso cuando el contrapeso Superlift no se eleva del suelo (p. ej. grúa con cargas según indicadas entre paréntesis en la tabla de cargas).

Cabestrante H3 Cabestrante adicional para pluma principal (para operar LF o runner), tracción de cable igual que H1, longitud 650 m.

Runner Capacidad máx. de elevación: 54 t. Montado en la cabeza de la pluma y en la parte superior de la pluma / plumín. Operado por el cable de cabestrante 3 (véase SL Variable).

Runner para LF estándar Capacidad de elevación máx. 18 t. Operado por el cabrestante 3.

Cabezal de conexión LF especial Sin juego de poleas para mayores capacidades de elevación cuando se empela LF.

Sección intermedia de 3 m Para longitudes intermedias de 3 m.

Base de giro central para PC

Consistindo de base de giro central e 4 estabilizadores.

Base de giro central	Estrutura soldada do tipo caixa, resistente a torção e empenamento, fabricada com aço estrutural de alta resistência e granulação fina.
Estabilizadores	Estrutura soldada resistente ao empenamento fabricada com aço estrutural de granulação fina e alta resistência. Os estabilizadores são formados por duas partes: a parte da conexão, de comprimento fixo, e a parte telescópica, para ajustá-los a uma de três bases de apoio. A parte telescópica pode ser soldada para facilitar o transporte até o canteiro.
Bases de apoio	12 m x 12 m 14 m x 14 m 16 m x 16 m
Patolas	As dimensões da patola padrão do estabilizador são 2,3 m x 2,3 m (5,3 m ²). Há suficiente afastamento entre essas patolas em uma base de apoio de 12 m x 12 m e a plataforma do Superlift em raio de 11 m. Temos disponíveis patolas de maior dimensão como item opcional. A plataforma do Superlift precisa ficar mais alta do que essas patolas em certos casos.

Superestrutura

Contrapeso	Contrapeso de 225 t na superestrutura. Tipo caixa de aço. Opções com blocos de 7,5 t e 10 t.
Peso total	Aprox. 340 t, incl. contrapeso de 225 t, lança de 24 m SH_1 e moitão.
Guincho de passagem	Montado na superestrutura.
Chassi	Estrutura soldada resistente à torsão fabricada com aço estrutural de granulação fina e alta resistência.
Anel de giro	Anel de giro com rolamento de três carreiras de rolos e coroa externa para facilidade de serviço e manutenção. Sistema de lubrificação central.
Tração	Caixa de engrenagens de distribuição para as bombas com cinco bombas de pistão axial com deslocamento variável e bombas de engrenagens. Silencioso com placa antifagulhas. Revestimento com isolamento sonoro. Motor a diesel de 6 cilindros MTU tipo 6R1300. Potência: 390 kW (523 HP) a 1700 rpm, torque de 2450 Nm (1807 lb-ft) at 1300 rpm cada. Os motores atendem os requisitos das normas EUROMOT 4, Tier 4 final e CARB. O sistema vem com aditivo Ad-Blue e conversor catalítico SCR. Opcional para mercados não regulamentados: Motor a diesel de 8 cilindros MTU tipo OM 502 LA. Potência: 405 kW (550 HP) a 1800 rpm, torque de 2600 Nm a 1080 rpm cada. Os motores atendem os requisitos das normas EUROMOT 3a, EPA T3 e CARB. Capacidade do tanque de combustível: 1217 l.
Tambores dos cabos de aço	O equipamento padrão da superestrutura inclui três tambores para cabos de aço – guincho 1, guincho 2 e guincho da lança. Os tambores são comandados por motores hidráulicos através de caixas fechadas com engrenagens planetárias em banho de óleo. Todos os tambores contam com freios multidisco de liberação hidráulica por ação de mola e frenagem hidráulica sem desgaste para a descida das cargas. Pontas dos cabos H 1, 2, 3 e W 1, 2 equipadas com conexões de engate rápido. Todos os guinchos são removíveis para reduzir o peso durante o transporte.
Suporte angular	Sistemas hidráulicos de elevação do suporte angular como item de série. O suporte angular, os guinchos da lança e seus conjuntos de roldanas podem ser desmontados como unidade inteira a fim de reduzir o peso para transporte. A desmontagem dos guinchos 1 e 2 é possível sem primeiro remover o suporte angular.
Unidade de giro	Comandadas por motores hidráulicos através de 2 caixas fechadas com engrenagens planetárias em banho de óleo. Freios de retenção por ação de mola com liberação hidráulica e frenagem hidráulica sem desgaste. Velocidade de giro de 0 a 1 rpm infinitamente variável.
Sistema de controle	Terex IC-1: Controle eletrônico proporcional do piloto da válvula integrado ao sistema de controle por programa armazenado incluindo sistema de diagnóstico. Dois monitores com tela colorida, indicador de momento de carga operado por tela de toque. Velocidades de trabalho infinitamente variáveis, controladas pela posição da alavanca. Controle automático de potência para máxima utilização do rendimento do motor; sistemas de controle de emergência. Outras funções: <ul style="list-style-type: none"> • Posição infinitamente variável do contrapeso do Superlift com sistema opcional de ajuste de 11 a 19 m • Posição infinitamente variável do ângulo da lança principal em configuração SWSL entre 55 e 87° (65 a 87° em configuração SW) • Limitação da área de trabalho • Diagnóstico e solução de problemas • Modo das alavancas de comando definido pelo usuário O guindaste é controlado por alavancas de comando ergonomicamente posicionadas na cabine. Controle remoto sem fio do içamento. Controle remoto sem fio de emergência.
Cabine	Cabine confortável com amplo parabrisa e ar condicionado. Vidros de segurança em toda a volta, teto solar, aquecedor de ar autônomo, instrumentação completa e controles do guindaste. Assento do operador livremente regulável, assento de emergência, vários porta-objetos, plugue elétrico de 12 V. A cabine pode ser reclinada para melhorar a visão da ponta da lança pelo operador. Há um sistema de câmera instalado para monitorar os tambores dos cabos de aço. A janela dianteira pode ser aberta. Painel regulável para melhor ergonomia e visualização. Limpador do parabrisa dianteiro com posição de descanso fora do campo visível. Para transporte, a cabine rebate hidráulicamente para a frente da superestrutura a fim de diminuir a largura.
Equipamentos elétricos	Sistema de 24 V (2 baterias de 12 V / 200 Ah).
Equipamentos de segurança	Indicador do momento de carga integrado em controle IC-1 (momento de carga, raio, ângulos, monitoração do funcionamento do motor e do sistema hidráulico), chave limitadora do guincho, chaves limitadoras dos movimentos da lança, batentes hidráulicos da lança, luz de posição, anemômetro.

Combinações de lanças

Ver página 16-21.

Equipamentos opcionais

Conexão hidráulica de engate rápido

Sapatas dos estabilizadores de 6,0 m x 2,4 m 14,4 m² em vez das patolas padronizadas de 5,3 m². Para reduzir a pressão sobre o solo.

Placas alternativas do contrapeso Feitas de ferro fundido (menos altura do que as placas padronizadas tipo caixa de aço).

Arranjo do contrapeso Composição de 10 t + 7,5 t ou 10 t + 15 t.

Placas de contrapeso no SL Até 350 t consistindo de placas padronizadas de 10 t ou 10 t e 7,5 t combinadas, em caixas de aço ou ferro fundido.

Adaptadores para linhas de eixo Adaptadores para transporte rodoviário da base de giro central e da superestrutura com linhas de eixo (Faymonville, Goldhofer, Scheuerle) ou para transporte no canteiro de obra com SPMT.

Pistão hidráulico do suporte angular Para montagem autônoma da lança.

Pistão hidráulico com ou sem unidade hidráulica Para pinagem da lança.

Kit do extensor da lança Consiste de 2 seções adaptadoras de 12 m e até 7 suplementos de 12 m. Disponíveis para comprimentos de 24 m, 48 m, 60 m, 84 m, 108 m. Disponível para torre do Superlift de 36 m a 39,5 m ou 42 m.

Flex Frame Livre posicionamento do contrapeso do Superlift de 13 a 21 m.

Split Tray Estrutura da plataforma do Superlift com outra plataforma removível embaixo da pilha de contrapesos (pilha central máx. 125 t).

SL padrão Mastro do Superlift 36 m incl. guincho W2. Barras pendentes do SL, cilindros dos batentes da lança, base do SL. Contrapeso do Superlift 0 t em raio de 9 m ou 0 a 325 t na caixa do contrapeso com raios fixos de 11 m, 13 m, 15 m, 17 m e 19 m.

SL variável Mastro do Superlift 36 m variável (ver SL padrão). Complemento de cilindros hidráulicos verticais e guincho de estabilização na superestrutura (impede o jogo do contrapeso especialmente durante o deslocamento e o giro). Compensação da altura usando os cilindros possibilita, até certo ponto, o içamento por cima de obstáculos. Contrapeso do Superlift 0 t no raio de 9 m ou 0-325 t na caixa do contrapeso, infinitamente variável de 11 m a 19 m.

Veículo do contrapeso do SL Mastro do Superlift (ver SL padrão). Estrutura telescópica e veículo do contrapeso com peso total de 325 t, 4 rodas / 2 eixos (movido e esterçável – total capacidade de manobra em modos de giro, rebocado e paralelo). Contrapeso do Superlift 40 a 325 t sobre veículo com raio do mastro fixo de aprox. 16 m; Infinitamente ajustável entre 13 e 17 m ou 17 e 19 m com estrutura telescópica. O veículo do contrapeso permite o deslocamento e o giro mesmo quando o contrapeso do superlift não sai do chão (p.ex. guindaste com as cargas indicadas pelos valores da tabela de cargas entre parênteses).

Guincho H3 Guincho adicional para a lança principal (para operação com LF ou runner), tração no cabo igual a H1, comprimento 650 m.

Ponta de montagem (Runner) Capacidade máx. de 54 t. Instalado na cabeça da lança e no topo do conjunto principal / auxiliar. Operação por cabo de guincho 3 (ver SL Variável).

Runner para LF padrão Capacidade máx. içamento 18 t. Operada pelo guincho 3.

Cabeça de ligação à LF especial Sem conjunto de roldanas para maior capacidade de içamento durante o uso da LF.

Seção intermediária de 3 m Para comprimentos intermediários de 3 m.

Центральная чаша кранов серии PC

	Включает центральную чашу и 4 выдвижные опоры.
Центральная чаша	Сварная конструкция в форме чаши из высокопрочной, мелкозернистой конструкционной стали прочной на изгиб и скручивание.
Выдвижные опоры	Сварная конструкция из высокопрочной, мелкозернистой конструкционной стали, прочной на изгиб. Выдвижные опоры состоят из двух частей: соединительной части фиксированной длины и телескопической части для регулировки положения опор при установке на одну из трех опорных баз. Телескопическая часть может быть сложена для удобства транспортировки на строительной площадке.
Опорные базы	12 м x 12 м 14 м x 14 м 16 м x 16 м
Плиты опор	Стандартные размеры плиты составляют 2,3 м x 2,3 м (5,3 м ²). При опорной базе 12 м x 12 м обеспечивается достаточный зазор между этими плитами и платформой для противовесов Superlift на радиусе Superlift в 11 м. В качестве опции доступны плиты больших размеров. В некоторых случаях платформу для противовесов Superlift приходится поднимать над этими плитами.

Надстройка

Противовес	225 т противовеса на надстройке. Стальная конструкция коробчатого типа. Варианты веса поставляемых блоков 7,5 т и 10 т.
Общий вес	Прибл. 340 т, включая противовес 225 т, стрелу длиной 24 м SH_1 и крюкоблок.
Запасовочная лебедка	Установлена на надстройке.
Рама	Сварная конструкция прочная на изгиб и скручивание, изготовленная из высокопрочной мелкозернистой конструкционной стали.
Опорно-поворотный круг	Опорно-поворотный круг с катковой опорой с тремя рядами подшипников качения для легкого обслуживания. Система централизованной смазки.
Привод	Раздаточная коробка насосов с пятью поршневыми насосами с регулированием объема и шестеренными насосами. Глушитель с искрогасителем. Шумопоглощающий кожух. дизельных 6-цилиндровых двигателя MTU типа 6R1300. Выходная мощность: 390 кВт (523 л.с.) при 1700 об/мин, вращающий момент 2450 Нм (1807 lb-ft) при 1300 об/мин; Двигатель соответствует требованиям стандартов EUROMOT 4, TIER 4 конечный и CARB. Система оснащена топливной системой Ad-Blue с каталитическим нейтрализатором SCR. Опционально для нерегулируемых рынков: дизельных 8-цилиндровых двигателя MTU типа OM 502 LA. Выходная мощность: 405 кВт (550 л.с.) при 1800 об/мин, вращающий момент 2600 Нм при 1080 об/мин, каждый. Двигатель соответствует требованиям стандартов EUROMOT 3a, EPA T3 и CARB. Емкость топливного бака: 1217 л.
Канатные барабаны	Стандартная комплектация оборудования надстройки включает три тросовых барабана – лебедок 1 и 2 и лебедки стрелы. Барабаны приводятся в движение гидравлическими двигателями через планетарную передачу, вращающуюся в масляной ванне в закрытом корпусе. Каждый канатный барабан имеет подпружиненный многодисковый тормоз с гидросилителем и неизнашивающийся гидравлический тормоз для опускания груза. Концы тросов для лебедок H 1, 2, 3 и W 1, 2 имеют быстроразъемные соединительные концевые фитинги. Все лебедки съемные для уменьшения веса при транспортировке.
A-образная рама	Гидравлическая система подъема A-образной рамы входит в стандартную комплектацию. A-образная рама, комплект шкивов для лебедки подъема стрелы снимается и перевозится одним блоком для уменьшения веса крана при перевозке. Снятие лебедок 1 и 2 возможно без снятия сначала A-образной рамы.
Поворотный механизм	Приводятся в движение гидравлическими двигателями через планетарную передачу, вращающуюся в масляной ванне в закрытом корпусе. Подпружиненный гидравлический тормоз-замедлитель и неизнашивающийся гидравлический тормоз. Скорость поворота надстройки с бесступенчатой регулировкой в диапазоне 0-1 об/мин.
Система управления	Tegeh IC-1: Система электронного пропорционального управления через регулирующие клапаны, встроенная система управления, включающая диагностическую систему. 2 монитора с цветными дисплеями, индикатор момента нагрузки, управляемый через сенсорный экран. Бесступенчатая регулировка рабочих скоростей изменением положения рычага. Автоматическая регулировка мощности для оптимизации выходной мощности двигателя; системы аварийного управления. Дополнительные функции: <ul style="list-style-type: none"> • бесступенчатая регулировка положения противовеса с регулируемой системой суперлифт 11-19 м (опция); • бесступенчатая регулировка угла наклона главной стрелы в конфигурации SWSL в пределах 55-87° (65-87° в конфигурации SW); • ограничитель рабочей зоны; • диагностика и выявление неисправностей; • заданный пользователем режим джойстика. Кран управляется с помощью рычагов джойстиков, эргономически расположенных в кабинах крана. Радиоуправление дистанционного управления сборкой Радиоуправление аварийного управления.
Кабина	Комфортабельная кабина с большим ветровым стеклом и кондиционером. Безопасное остекление всех дверей и окон, потолочный люк, независимый воздушный обогреватель, полный комплект приборов и органов управления краном. Сиденье оператора с бесступенчатой регулировкой, аварийное сиденье, большое количество ящиков для хранения, разъем питания 12 В. Кабина откидывается назад для лучшего обзора конца стрелы крана. Для управления канатными барабанами установлена система камер. Переднее окно открывается. Положение панели приборов регулируется, обеспечивая оптимальную эргономику и обзор. Передний стеклоочиститель ветрового стекла с позицией парковки, не закрывающей зону обзора. При транспортировке кабина вертикально откидывается перед надстройкой для сокращения ширины.
Электрическое оборудование	24 В постоянного тока (2 аккумуляторных батареи 12 В, 200 Ач).
Дополнительные устройства	Индикатор момента нагрузки, встроенный в схему управления ИС-1, (момент нагрузки, радиус, углы, контроль гидравлической системы), ограничитель лебедки, ограничители движения стрелы, гидравлический ограничитель обратного хода стрелы, позиционный фонарь, анемометр.

Комбинации стрелы

см. на стр. 16-21.

Дополнительное оборудование

Гидравлическая система
быстроразъемных
соединений

Опорные плиты выдвижных опор 6,0 м x 2,4 м	14,4 м ² вместо стандартной площади плиты 5,3 м ² . Для снижения давления на грунт.
Альтернативный вариант плит противовеса	Из чугуна (меньше по высоте, чем стандартные стальные плиты коробчатой формы).
Системы противовесов	Комбинация 10 т + 7,5 т или 10 т + 15 т.
Плиты противовесов для стрел SL	До 350 т из стандартных плит 10 т или комбинированного типа из плит 10 т и 7,5 т, стальных коробчатого типа, либо из чугуна.
Адаптеры для осевых линий	Адаптеры для транспортировки автомобилем центральной чаши и надстройки с осевыми линиями (Faymonville, Goldhofer, Scheuerle) или для перевозки на стройплощадку при помощи самоходного модульного транспортера.
А-образная рама с гидравлическим цилиндром	Для самосборки стрелы.
Гидравлический цилиндр с или без гидравлического блока	для штифтовой сборки стрелы.
Комплект усилителя стрелы Boom Booster	Состоит из 2 переходных секций по 12 м и до 7 удлинительных секций по 12 м. Варианты длины: 24 м, 48 м, 60 м и 84 м, 108 м. Возможность удлинения мачты Superlift с 36 м до 39,5 м или 42 м.
Flex frame	Бесступенчатое позиционирование противовеса Superlift в диапазоне 13-21 м.
Платформа Split Tray	Платформа для противовесов Superlift с возможностью удаления платформы из под центрального штабеля противовесов (вес центрального штабеля максимум 125 т).
Стрела Standard SL	36 м с мачтой Superlift вкл. лебедку W2. Растяжки системы подвески SL, цилиндры заднего упора мачты, платформа тягача для перевозки противовесов SL. Противовес superlift 0 т при радиусе 9 м или 0-325 т платформе тягача для перевозки противовесов при фиксированных радиусах 11 м, 13 м, 15 м, 17 м и 19 м.
SL с бесступенчатой регулировкой	Мачта Superlift 36 м с бесступенчатой регулировкой (см. стрелу Standard SL). Дополнительные гидравлические цилиндры вертикального подъема и стабилизирующая лебедка на надстройке (предотвращает колебания противовесов особенно при транспортировке и вращении). Компенсация высоты при помощи этих цилиндров, подъем через препятствия возможен в ограниченной степени. Противовес superlift 0 т при радиусе 9 м или 0-325 т на платформе тягача для перевозки противовесов при бесступенчатой регулировке радиуса в диапазоне 11-19 м.
Тягач с платформой для перевозки противовесов SL	мачта Superlift (см. стрелу Standard SL). Телескопической рама и тягач с платформой для перевозки противовесов, рассчитанная на общий вес 325 т, с 4 колесами / 2 осями (ведущая и рулящая – обеспечивающие полную маневренность при вращении, буксировке и движении в параллельном режиме). Противовес Superlift 40-325 т на платформе тягача для перевозки противовесов с фиксированным радиусом около 16 м; с бесступенчатой регулировкой 13-17 м или 17-19 м соответственно с телескопической рамой. Тягач с платформой для перевозки противовесов позволяет перемещение или разворот шасси крана, даже не поднимая противовес superlift с земли (т.е. крана с поднимаемым весом, указанным в таблице нагрузок в скобках).
Лебедка H3	дополнительная лебедка для главной стрелы (для работы со стрелой LF или подвижным блоком), тяговое усилие на тросе то же, что и на лебедке H1, длина 650 м.
Подвижной блок	Макс. грузоподъемность 54 т. Устанавливается на головке стрелы или на верхней секции главной/вспомогательной стрелы. Управление с помощью троса лебедки 3 (см. SL с бесступенчатой регулировкой).
Подвижной блок для стандартной стрелы LF	Макс. грузоподъемность 18 т. Выполняется лебедкой 3.
Специальная	без шкива, устанавливается для увеличения грузоподъемности при работе со стрелой LF.
Промежуточная секция 3 м	Для 3-метровых промежуточных удлинителей.

Notes

PC 3800-1

Notizen · Notes · Nota · Notas · Notas ·
пометы, комментарии, примечания

A large rectangular area with horizontal lines, intended for taking notes.

Notes

PC 3800-1

Notizen · Notes · Nota · Notas · Notas ·
пометы, комментарии, примечания

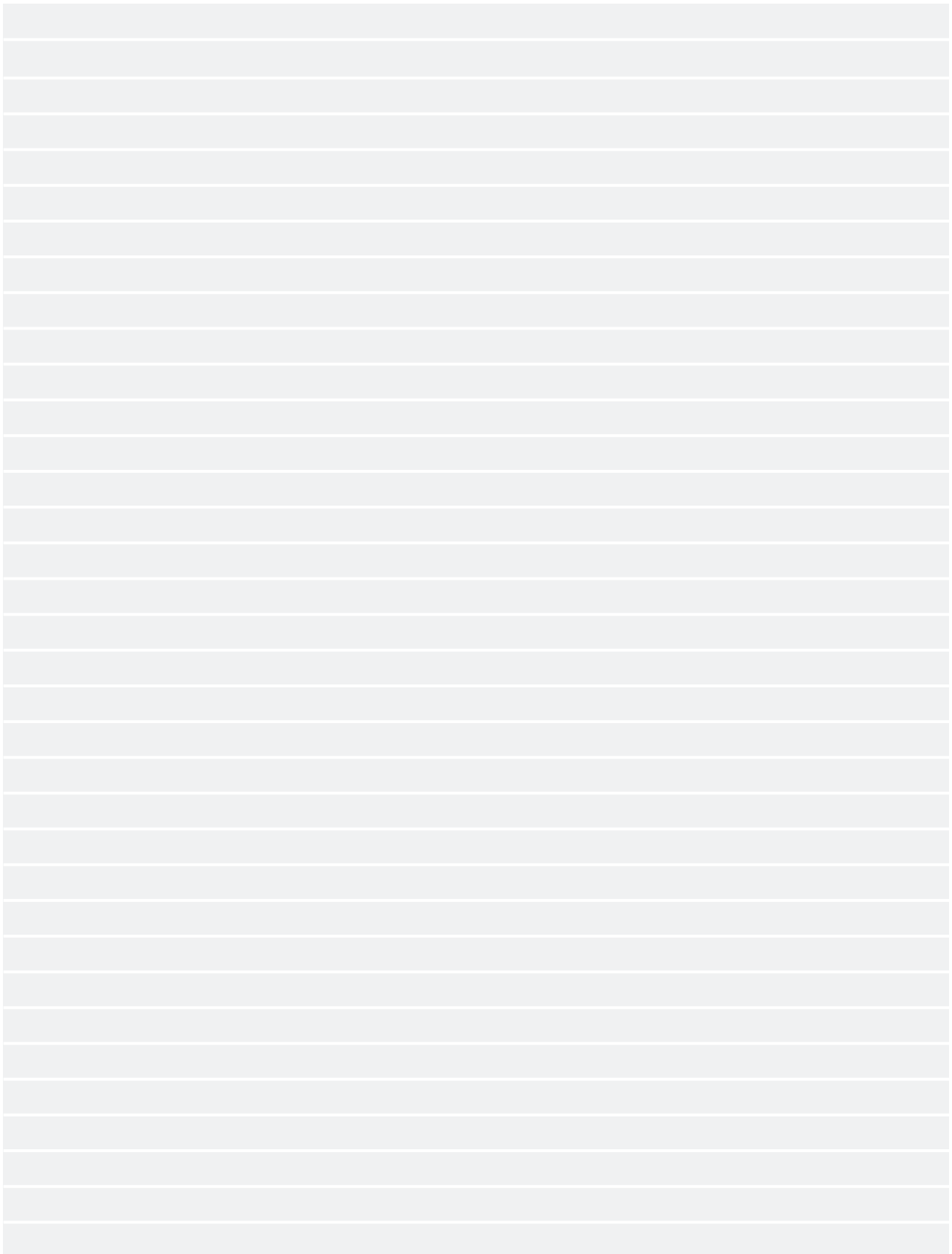

February 2019. Product specifications and prices are subject to change without notice or obligation. The photographs and/or drawings in this document are for illustrative purposes only. Refer to the appropriate Operator's Manual for instructions on the proper use of this equipment. Failure to follow the corresponding Operator's Manual when using our equipment or to otherwise act responsibly may result in serious injury or death. The only warranty applicable to our equipment is the standard written warranty applicable to the particular product and sale and Terex makes no other warranty, express or implied. Products and services listed may be trademarks, service marks or trade-names of Terex Corporation and/or its subsidiaries in the USA and other countries. All rights are reserved. Terex, Demag and Above, Ahead, Always are trademarks of or licensed by Terex Corporation or its subsidiaries.

Februar 2019. Irrtum und Änderungen der Produktspezifikationen vorbehalten. Die in diesem Dokument enthaltenen Fotos und/oder Zeichnungen dienen rein anschaulichen Zwecken. Für den sachgemäßen Gebrauch der Maschinen ist das entsprechende Bedienerhandbuch heranzuziehen. Unsachgemäßer Umgang mit bzw. unsachgemäßer Einsatz unserer Maschinen kann zu schweren gesundheitlichen Schäden bis hin zum Tod führen. Für unsere Produkte wird ausschließlich die entsprechende, schriftlich niedergelegte Standardgarantie gewährt. Terex leistet keinerlei darüber hinausgehende Garantie, weder ausdrücklich noch stillschweigend. Die genannten Produkte und Dienstleistungen sind in den USA und anderen Ländern ggf. Marken, Dienstleistungsmarken oder Handelsnamen der Terex Corporation und/oder ihrer Tochtergesellschaften. Alle Rechte vorbehalten. Terex, Demag und Above, Ahead, Always sind Marken in Eigentum oder Lizenz der Terex Corporation bzw. ihrer Tochtergesellschaften.

Février 2019. Les caractéristiques et prix des produits peuvent faire l'objet de modifications sans notification préalable. Les photographies ou dessins présentés dans ce document servent uniquement à des fins d'illustration. Pour connaître les instructions relatives à l'utilisation correcte de cet équipement, veuillez vous référer au manuel de l'utilisateur correspondant. Le non-respect du manuel d'utilisateur correspondant lors de l'utilisation de notre équipement ou des actes irresponsables risquent de provoquer de graves blessures, voire un décès. La seule garantie applicable à nos équipements est la garantie écrite standard applicable au produit et à la vente spécifiques. Terex ne délivre aucune autre garantie, expresse ou implicite. Les produits et les services mentionnés peuvent être des marques, des marques de service ou des appellations commerciales de Terex Corporation et/ou de ses filiales aux États-Unis et dans d'autres pays. Tous droits réservés. Terex, Demag et Above, Ahead, Always sont des marques déposées, propriétés ou sous licence de Terex Corporation ou de ses filiales.

Febbraio 2019. Specifiche e prezzi dei prodotti sono soggetti a modifica senza preavviso o altro obbligo. Le fotografie e i disegni in questo documento hanno esclusivamente scopo illustrativo. Consulta il Manuale dell'operatore pertinente per trovare istruzioni per l'utilizzo corretto di questo macchinario. La mancata osservanza delle istruzioni contenute nel relativo Manuale dell'operatore durante l'uso del macchinario e altri comportamenti irresponsabili possono provocare gravi lesioni, anche mortali. L'unica garanzia applicabile ai nostri macchinari è la garanzia scritta standard applicabile al particolare prodotto e alla particolare vendita e Terex è esonerata dal fornire qualsiasi altra garanzia, esplicita o implicita. I prodotti e servizi elencati possono essere dei marchi di fabbrica, marchi di servizio o nomi commerciali di Terex Corporation, e/o delle rispettive società affiliate negli Stati Uniti d'America e in molte altre nazioni. Tutti i diritti riservati. Terex, Demag e Above, Ahead, Always sono marchi di proprietà o concessi in licenza da Terex Corporation o dalle sue società affiliate.

Febrero 2019. Las especificaciones y los precios de los productos están sujetos a cambios sin necesidad de previo aviso ni ninguna otra obligación. Las fotografías y/o dibujos de este documento tienen un fin meramente ilustrativo. Consulte el correspondiente manual de instrucciones del operario para obtener más información sobre el uso correcto de esta maquinaria. No respetar el manual del operario al utilizar la maquinaria o actuar de forma irresponsable puede provocar lesiones graves e incluso mortales. La única garantía aplicable a nuestra maquinaria es la garantía escrita estándar de cada producto y venta. Terex no amplía dicha garantía de forma expresa ni implícita. Los productos y servicios mencionados pueden ser marcas comerciales, marcas de servicio o nombres de marca de Terex Corporation o de alguna de sus filiales en Estados Unidos y otros países. Todos los derechos reservados. Terex, Demag y Above, Ahead, Always son marcas registradas o con licencia de Terex Corporation o de sus filiales.

Fevereiro 2019. Especificações e preços dos produtos sujeitos a alteração sem aviso prévio ou obrigações. As fotografias e/ou desenhos neste documento são apenas para fins ilustrativos. Consulte o respectivo Manual do Operador para instruções sobre o uso correto deste equipamento. Deixar de acompanhar o respectivo Manual do Operador ao usar o nosso equipamento ou, por qualquer outra forma, deixar de agir de maneira responsável pode resultar em lesões corporais graves ou a morte. A única garantia aplicável ao nosso equipamento é a garantia padrão por escrito correspondente ao produto específico vendido. A Terex não dá outras garantias, expressas ou implícitas. Os produtos e serviços listados podem ser marcas comerciais, marcas de serviço ou nomes-fantasia da Terex Corporation e/ou suas subsidiárias nos EUA e em outros países. Todos os direitos reservados. Terex, Demag e Above, Ahead, Always são marcas comerciais pertencentes ou licenciadas pela Terex Corporation ou suas subsidiárias.

Февраль 2019. года Технические характеристики и цены могут изменяться без предварительного уведомления и без каких-либо обязательств для производителя. Фотографии и (или) чертежи в настоящем документе служат только в качестве иллюстраций. Инструкции по надлежащей эксплуатации данного оборудования см. в соответствующем руководстве для оператора. Невыполнение указаний соответствующих руководств для оператора при эксплуатации оборудования или другие безответственные действия могут повлечь серьезные травмы или смерть. Единственной гарантией, действующей в отношении нашего оборудования, является стандартная форма письменной гарантии на данный тип оборудования и на условия его продажи. Terex не дает никаких других гарантий: ни ясно выраженных, ни подразумеваемых. Перечисленные продукты и услуги могут быть торговыми марками, знаками обслуживания или торговыми наименованиями Terex Corporation и / или ее дочерних компаний в США и других странах. Все права защищены. Terex, Demag и Above, Ahead, Always являются торговыми марками, принадлежащими Terex Corporation или ее дочерним компаниям или лицензированы ими.

© Terex Cranes 2019

TEREX CRANES GERMANY GMBH

Europa Allee 2
66482 Zweibrücken
Germany

E info.cranes@terex.com
T +49 6332 830

www.demagmobilecranes.com



DEMAG
BY TEREX